



At the heart of your home

Rocco

Model No. FBFL**RN3

LOG EFFECT BALANCED FLUE ROOM HEATER

Installation and Maintenance Instructions

Hand these instructions to the user

Model No. FBFLRN3 is for use on Natural Gas (G20) at a supply pressure of 20 mbar in G.B. / I.E.**

**** Denotes trim & colour variant**

Information Requirements for Commission Regulation (EU) 2015/1188

Model Identifier	FBFL**RN3
Indirect Heating Functionality	No
Direct Heat Output	5.5kW
Indirect Heat Output	Not Applicable
Fuel	Natural Gas (G20)
NOx Emissions	130mg/kWh
Nominal Heat Output	5.5kW
Minimum Heat Output (Indicative, all models)	1.8kW
Useful Efficiency at Nominal Heat Output	80.8%
Useful Efficiency at Minimum Heat Output (Indicative)	50.0%
Auxilliary Power Consumption at Nominal Heat Output	0.01kW
Auxilliary Power Consumption at Minimum Output	0.01kW
Auxilliary Power Consumption at Standby Mode	0.01kW
Permanent Pilot Flame Requirement	Not applicable
Type of Heat Output / Room Temperature Control	Two or more manual stages, no room temperature control
Contact Details	BFM Europe Ltd. Gordon Banks Drive Trentham Lakes North Stoke-on-Trent ST4 4TJ Tel : 01782 339000

CONTENTS

	PAGE
Section 1 Information and Requirements	
1.0 Appliance information	3
1.1 Conditions of installation	4
1.2 Fireplace surround & suitability	4
1.3 Flue terminal position	5
1.4 Shelf position	6
1.5 Hearths	6
1.6 Installation to plastered wall surfaces	6
Section 2 Installation of Fire	
2.1 Unpacking the combustion chamber	7
2.2 Preparing the combustion chamber opening (In studded wall)	8
2.3 Preparing the combustion chamber opening (In chimney breast)	9-10
2.4 Installation of the gas supply	11
2.5 Specifying the flue system & components	12-14
2.6 Preparation of the wall	14
2.7 Preparation of the flue hole	15
2.8 Fitting the starter pipe	15-16
2.9 Fitting the flue pipes together	17
2.10 Fitting the flue terminal	18
2.11 Fitting the flue terminal guard	19
2.12 Removal & re-fitting of the glass frame	20
Section 3 Assembling Fuel Bed and Commissioning	
3.1 Fitting the fuel bed logset	21-25
3.2 Making the gas connection & checking for gas tightness	26
3.3 Lighting the appliance	26-28
3.4 Removal & re-fitting the trim	29
Section 4 Maintenance	
4.1 Removal of the burner assembly	30
4.2 Removal of the control valve	30-31
4.3 Removal of the ultrasonic receiver	31
4.4 Removal of the pilot assembly	31-32
4.5 Removal / Replacement of batteries in the Ultrasonic Receiver	32
4.6 Removal / Replacement of the handset battery	32

Model number FBFLRN3** manufactured by:-

BFM Europe Ltd, Trentham Lakes, Stoke-on-Trent, Staffordshire, ST4 4TJ

Appliance Efficiency Declaration

The efficiency of this appliance has been measured as specified in BS EN 613 : 2001 and the result is 74%. The gross calorific value of the fuel has been used for this efficiency calculation. The test data from which it has been calculated has been certified by Advantica. The efficiency value may be used in the UK Government's Standard Assessment Procedure (SAP) for energy rating of dwellings.

SECTION 1 INFORMATION AND REQUIREMENTS

1.0 APPLIANCE INFORMATION

Main injector : (1 off)	Bray Injector Cat 82 – size 480 (NG)
Pilot Type :	S.I.T. 140 Series NG – size 27
Max. Gross Heat Input :	7.5kW
Min. Gross Heat Input :	3.5 kW
Gas Rate :	0.691 m ³ /hr (High) 0.325 m ³ /hr (Low)
Cold Pressure :	G20 20.0+/-1.0 mbar (8.0 +/- 0.4 in w.g.)
Ignition :	Integral to gas valve
Electrode Spark Gap :	4.0mm
Packed Weight Combustion Chamber :	54.0 kg (Pack 1 of 1)
Packed Weight Flue Terminal Pack :	7.0 kg (Pack 2 of 2)

Fig 1

Top View of Combustion Chamber

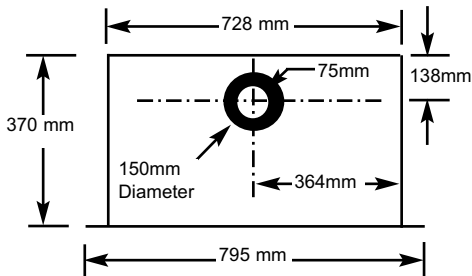

Side View of Combustion Chamber

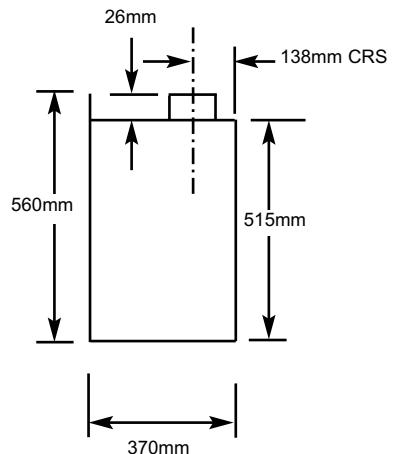

INSTALLATION REQUIREMENTS

1.1 CONDITIONS OF INSTALLATION

It is the law that all gas appliances are installed only by a GAS SAFE Registered Installer, in accordance with these installation instructions and the Gas Safety (Installation and Use) Regulations 1998 as amended. Failure to install appliances correctly could lead to prosecution. It is in your own interest and that of safety to comply with the law.

The installation must also be in accordance with all relevant parts of the Local and National Building Regulations where appropriate, the Building Regulations (Scotland Consolidation) issued by the Scottish Development Department, and all applicable requirements of the following British Standard Code of Practice.

1. B.S. 5871 Part 1 Installation of Gas Fires
2. B.S. 6891 Installation of Gas Pipework
3. B.S. 5440 Parts 1 & 2 Installation of Flues and Ventilation
4. I.S 813 : 1996 Domestic Gas Installation, issued by the National Standards Authority of Ireland.

1.2 FIREPLACE / SURROUND SUITABILITY

The fire must only be installed on a hearth it **must not be installed directly onto carpet or other combustible floor materials.**

The fire is suitable for fitting to non-combustible fire place surrounds and proprietary fire place surrounds with a temperature rating of at least 150°C.

If a heating appliance is fitted directly against a wall without the use of a fire surround or fire place all combustible material must be removed from behind the trim. Soft wall coverings such as blown vinyl, wall paper etc. could be affected by the rising hot air and scorching and/or discoloration may result. Due consideration should be made to this when installing or decorating.

1.3 FLUE TERMINAL POSITION

The minimum acceptable dimensions from the flue terminal to obstructions and ventilation openings are shown below and listed in the table. It is important that the position of the flue allows the free passage of air across it at all times. The minimum acceptable space from the flue terminal to obstructions and ventilation openings are specified below (Fig. 2)

Fig. 2

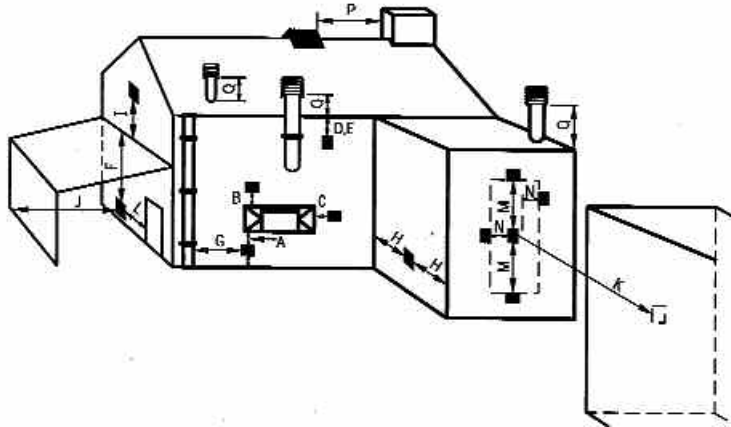

DIMENSION	TERMINAL POSITION	MINIMUM DIMENSION
A	Directly below an opening, air brick, opening window	300mm (12in)
B	Above an opening, air brick, opening window	300mm (12in)
C	Horizontally to an opening, air brick, opening window etc.	
D	Below gutters, soil pipes or drain pipes	300mm (12in)
E	Below eaves	300mm (12in)
F	Below balconies or car port roof	600mm (12in)
G	From a vertical drain pipe or soil pipe	300mm (12in)
H	From an internal or external corner	600mm (24in)
I	Above ground roof or balcony level	300mm (12in)
J	From a surface facing the terminal	600mm (24in)
K	From a terminal facing the terminal	600mm (24in)
L	From an opening in the car port	1200mm (48in)
M	Vertically from a terminal on the same wall	1500mm(59in)
N	Horizontally from a terminal on the same Wall	300mm (12in)
O	NOT APPLICABLE	N/A
P	NOT APPLICABLE	N/A
Q	NOT APPLICABLE	N/A

1.4 SHELF POSITION

The fire may be fitted below a combustible shelf providing there is a minimum distance of 300mm above the top of the fire and the shelf does not project more than 150mm. If the shelf overhangs more than 150mm the distance between the fire and the shelf must be increased by 15mm for every 25mm of additional overhang over 150mm.

1.5 HEARTHES

This appliance does not require the fitting of a hearth that projects in front of it when installed into a recess in either an existing chimney breast or a studded wall. The appliance must however stand on a non-combustible base that is a minimum thickness of 12mm

1.6 INSTALLATION TO PLASTERED WALL SURFACES

If installing to a plastered wall, all material must be removed from the 50mm area surrounding the combustion chamber opening, and replaced with non-combustible material, such as marble or granite, to prevent plaster cracking. See Fig. 3 below

Fig. 3

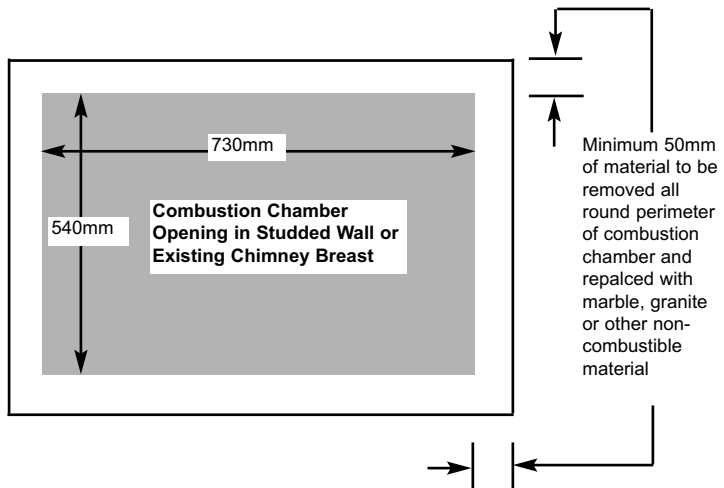

SECTION 2 INSTALLATION OF FIRE

2.1 UNPACKING THE COMBUSTION CHAMBER

Carefully lift the combustion chamber out of the carton. Remove the loose item packaging carefully from the pack. Check the contents as listed :-

DO NOT UNDER ANY CIRCUMSTANCES USE THIS APPLIANCE IF THE GLASS PANEL IS BROKEN OR NOT SECURELY FIXED TO THE FIREBOX.

Packing Check List

Pack 1 of 2 - Combustion Chamber Pack

- 1 off Combustion Chamber & Glass Frame Assembly
- 1 off Trim (packed in front section of combustion chamber pack)
- 1 off Boxed ceramic fuel-bed set (packed inside combustion chamber)
- 1 off Installation Instruction Manual
- 1 off User Instruction Manual
- 1 off Flue Terminal Guard
- 1 off Outer Flue Gasket
- 1 off Remote Handset
- 1 off 9V Battery
- 4 off AA Batteries
- 1 off Guarantee Card
- 1 off Loose Items pack – containing :-
 - 6 off M6 wingnuts
 - 4 off No. 12 x 40mm Screws
 - 4 off Rawlplugs

Carefully lift the flue kit components out of the carton. Remove the loose item packaging carefully from the pack. Check the contents as listed :-

Pack 2 of 2 - Flue System Pack

- 1 off Flue Terminal
- 1 off 150mm Starter Pipe
- 1 off *Telescopic Flue Pipe - supplied in two separate sections
- 1 off 90 degree elbow
- 3 off Pipe Clips

*These two sections of the telescopic need to be assembled by the installer to form the 250mm to 410mm telescopic piece.

2.2 PREPARATION OF THE COMBUSTION CHAMBER OPENING (INTO STUDDED WALL)

All combustible parts of the studwork must be set at the distances as shown below in Fig. 4 & 5.

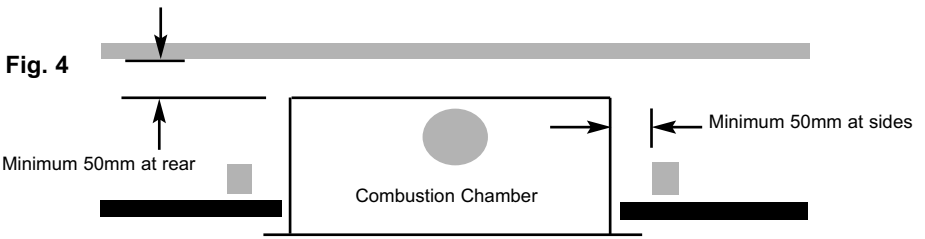

Refer to Fig. 1 on page three for dimensions of the flue outlet.

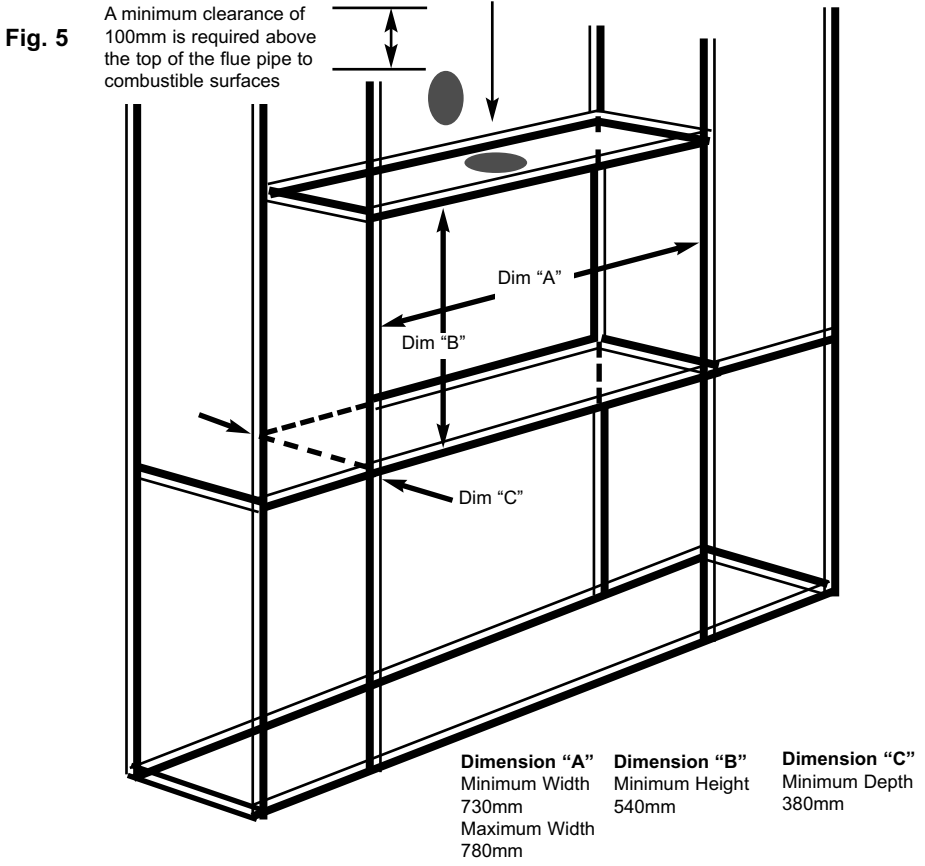

2.3 PREPARATION OF THE COMBUSTION CHAMBER OPENING (INTO EXISTING CHIMNEY BREAST)

An opening should be constructed to the following dimensions in the existing chimney breast.

Fig. 8

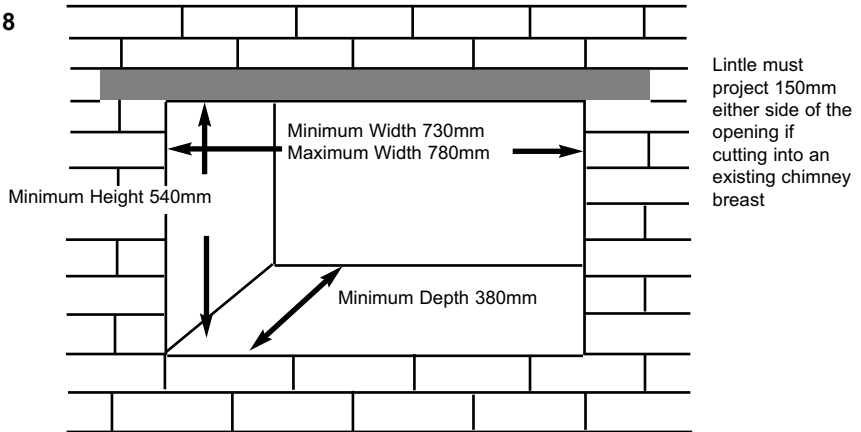

The opening needs to be sufficient to accommodate the combustion chamber. To support the wall above the opening, a suitable lintel must be inserted across the top of the opening. The lintel could be either pre-cast concrete or steel - Catnic CN52 or CN 46 could be used, depending upon the inner wall thickness. Before proceeding with the installation of the fire, an assessment of the area immediately above the fire is required, see Fig. 9 overpage. If there is no existing openings within either triangle, proceed with forming the opening. However, if opening or beams occur within either triangle, then you should seek specialist advice from a structural engineer or consider relocating the proposed position of the firebox.

NOTE : Please ensure that suitable cut outs in the sides and front face of the chimney breast are implemented for fixing of the flue pipe, and for future servicing.

Fig. 9

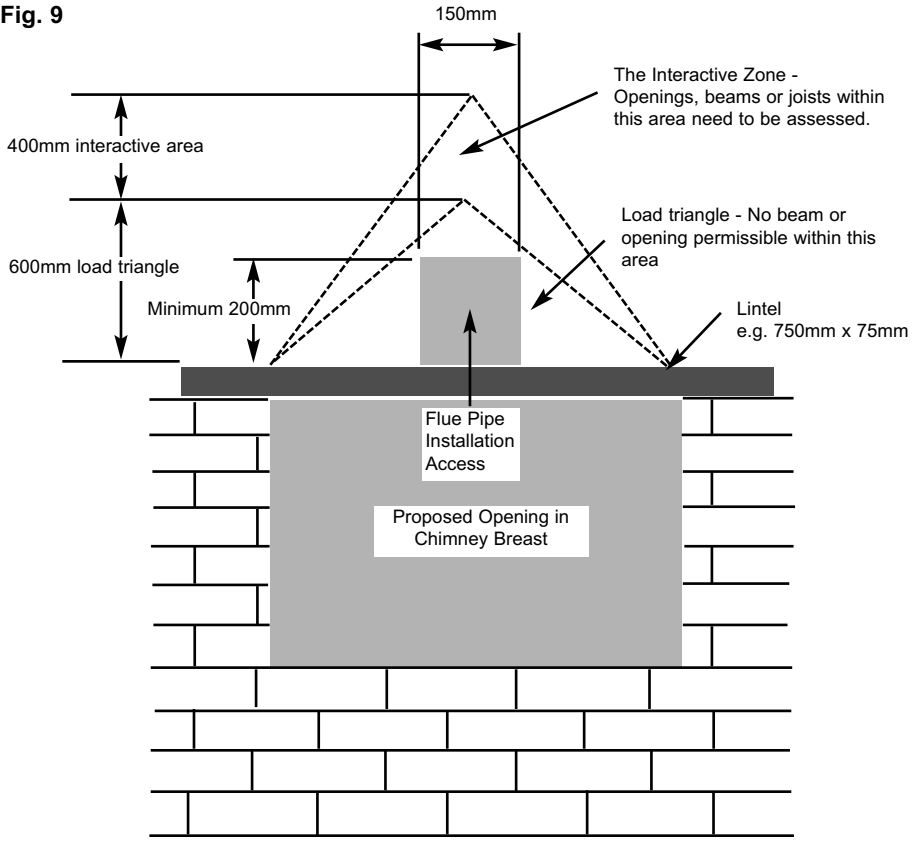

2.4 INSTALLATION OF THE GAS SUPPLY (INTO STUDDED WALL OR EXISTING CHIMNEY BREAST)

Before installing the combustion chamber, decide from which side or if a rear connection to the gas supply is required. Plan the pipe run to enter the below the firebox from the left, right or rear and connect to the inlet elbow. See Fig. 10, 11 & 12 below.

Note : Before breaking into the gas supply a gas tightness test should be carried out to establish that the existing pipework is sound.

Fig. 10

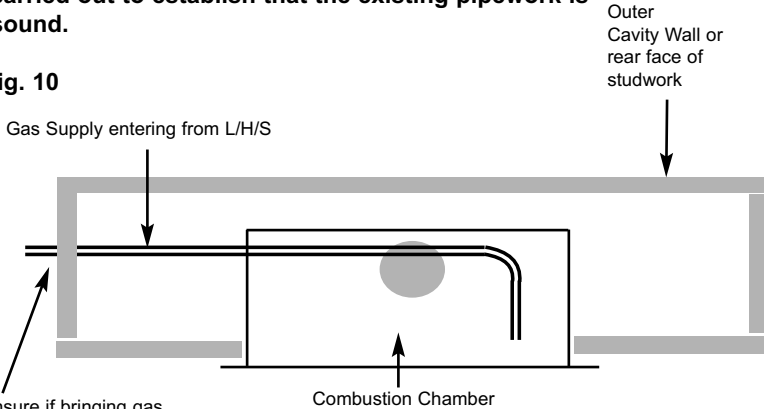

Ensure if bringing gas supply through side or rear of a chimney breast that the pipe is sleeved and sealed with a suitable flexible, non setting compound

Gas Supply entering from Rear of Combustion Chamber

Fig. 11

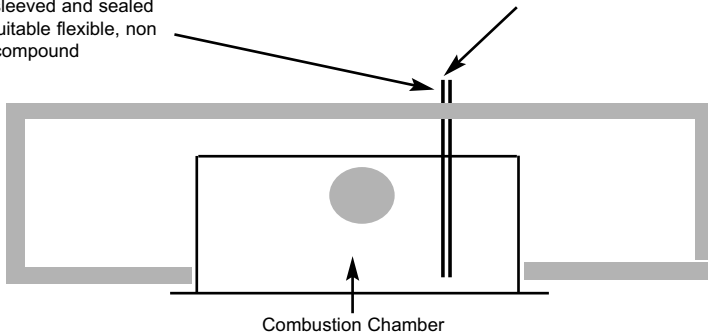
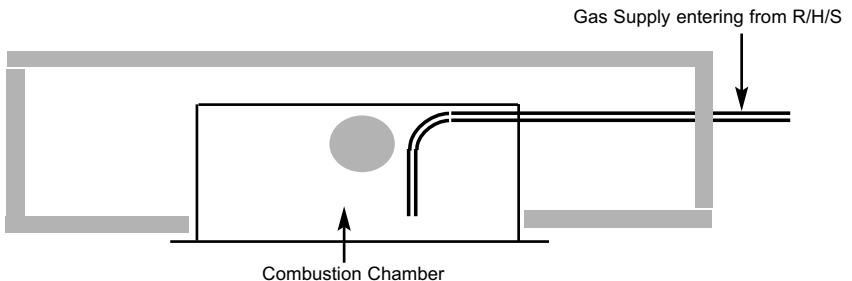

Fig. 12



2.5 SPECIFYING THE FLUE SYSTEM & ASSOCIATED COMPONENTS

This product requires a minimum vertical flue length of 150mm (6 inch). The horizontal length can then be extended up to a maximum of 1600mm, giving a total depth from mounting flange to outer wall of 2000mm.

The standard flue kit supplied with the product comprises the following components :-

- 1off Flue Terminal
- 1off Flue Terminal Guard
- 1off 150mm Starter Pipe
- 1off 250mm Minimum to 410mm Maximum Telescopic Flue Pipe
- 1off 90 degree elbow 3 off pipe clips

This kit comprises the components required to fit the appliance into a studded wall or a chimney breast with a maximum depth of 880mm (From Mounting Flange of Combustion Chamber to outer face of wall) The main flue pipe section is a telescopic item which allows for a variation in depth of 160mm minimum to maximum length (250mm to 410mm). See Fig. 13 below.

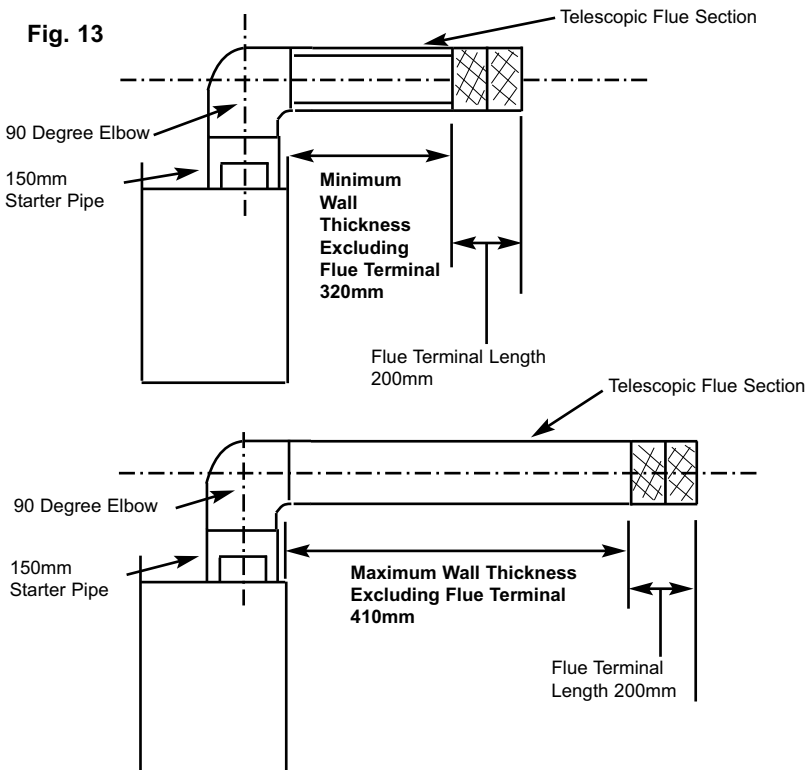

In instances where a large depth cavity wall, chimney breast is encountered, or if the installation requires a flue termination to the left or right hand of the combustion chamber, the overall length from the centre of the flue spigot can be increased up to 1600mm as shown below in Fig. 14

Fig. 14

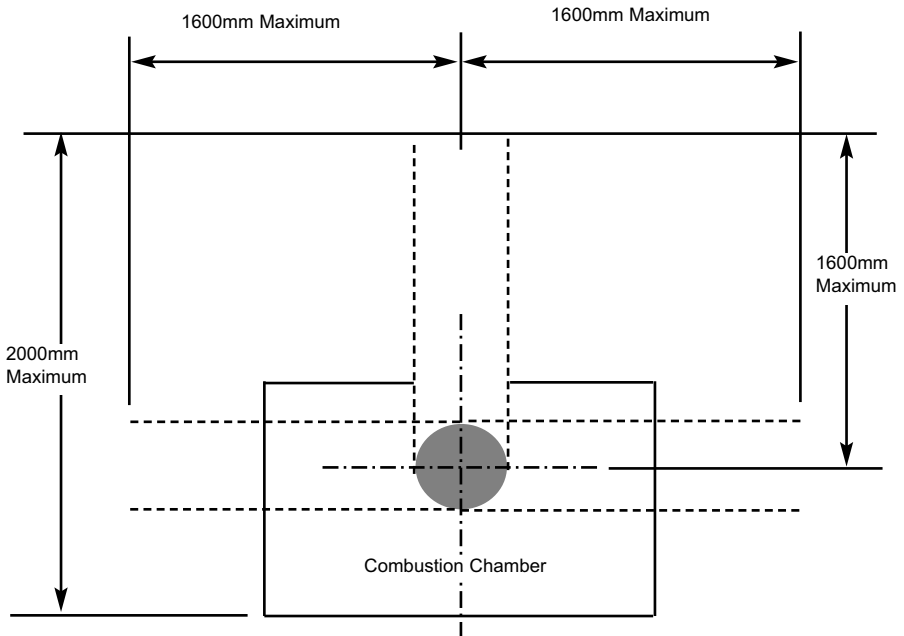

In installation's where components are required that exceed the limitations of the components supplied with the standard kit, extra lengths of flue pipe are available from BFM Europe Ltd. The lengths available and part no's are shown below.

B-83970	1000mm Flue Length Section
B-83980	500mm Flue Length Section
B-83990	250mm Flue Length Section
B-84000	150mm Flue Length Section

Always ensure that the solid section is fitted to the elbow when installing extra sections, followed by the telescopic section as supplied in the standard flue kit, this will allow for differences in cavity wall depth to be allowed for. See Fig. 15 overpage

Fig. 15

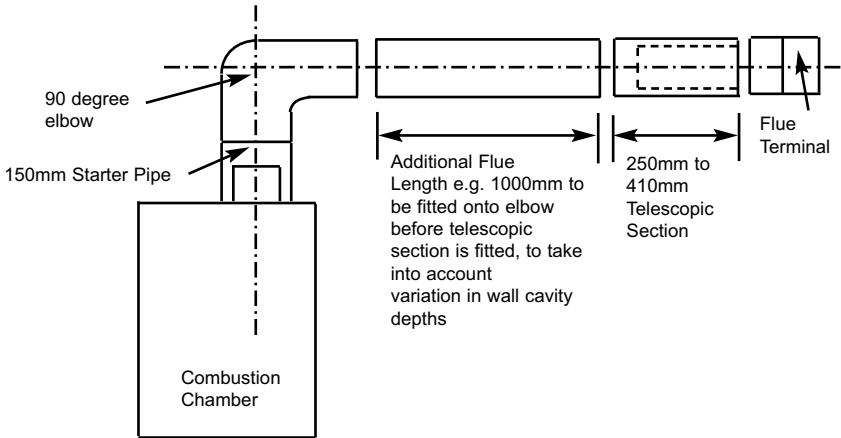

2.6 PREPARATION OF THE WALL / MOUNTING

The appliance and flue pipes must be installed at right angles to the mounting wall. The appliance itself should be installed vertically against a flat wall. Where an uneven wall surface is found, appropriate action should be taken to ensure that the appliance is not stressed or does not distort when installed. Ensure that the floor surface onto which the appliance is mounted onto is flat. The minimum height from the mounting base to the centre of the flue is shown on below in Fig. 16.

Fig. 16

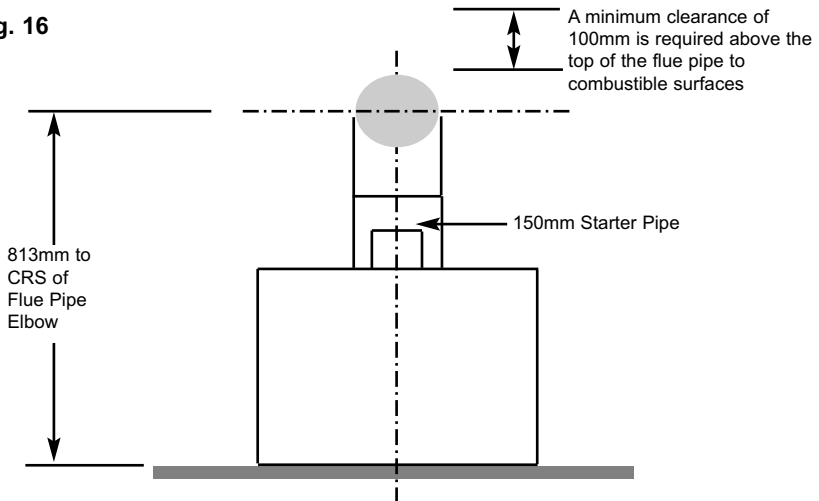

2.7 PREPARATION OF THE FLUE HOLE

- a) Mark the position of the centre of the flue on the inner wall. (See Fig. 16 on previous page for position).
- b) Cut hole for outer flue pipe. There are two possible methods to achieve this, either core drill or via hammer and chisel.
- c) To core drill, proceed as follows :-

Drill a pilot hole through the wall, in position as specified in figure 16 on previous page.

Using a 6" core drill, drill the flue hole.

To Hammer and chisel, proceed as follows :-

Mark the position of the centre of the flue pipe as specified in figure 16.

Mark the position of the hole around this point.

Chisel out the area as marked on the wall.

We then recommend that a cardboard cylinder is placed around the flue pipe and inserted in the chiselled out hole whilst making good.

NOTE :- If the appliance is to be installed into a building under construction, it is recommended that a non-corrosive metal tube of 6" diameter be inserted into the position of the hole as specified on page 16.

2.8 FITTING THE STARTER PIPE TO THE APPLIANCE

- a) Place gasket on top of the combustion chamber as shown below in Fig. 17

Fig. 17



- b) The starter pipe is attached to the appliance by placing it over the spigot on the combustion chamber and locating the mounting flange over the weld studs that protrude from the top panel on the combustion chamber. (See Fig. 18 below)

Fig. 18

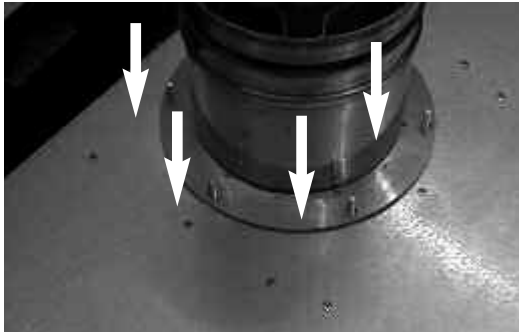

- c) When the starter pipe is located, tighten the 6 off wingnuts (supplied in loose items pack) to seal the starter pipe to the combustion chamber. (See Fig. 19 below)

Fig. 19



- d) Fit the 90 degree elbow in the required direction of the flue pipe (L/H, R/H or to the rear), and secure to the starter pipe with the clamps as shown in section 2.9.

2.9 FITTING THE FLUE PIPES TOGETHER

- a) The flue pipes are located by pushing the sections together and clamping using the clamps provided. As with all balanced flue appliances ensure that the flue sections are fitted together horizontally.
- b) The clamps are fitted together as shown below in Fig. 20 & 21

Fig. 20



Fig. 21



2.10 FITTING THE FLUE TERMINAL

- a) The flue terminal locates over the telescopic flue section and is clamped as per the other flue sections. The flue terminal must not protrude out of the wall further than 150mm. This is indicated by the ridge on the terminal itself. **Failure to comply with this request will result in poor performance of the product during adverse weather conditions.** See fig. 22 below for correct positioning of the flue terminal.

Fig. 22

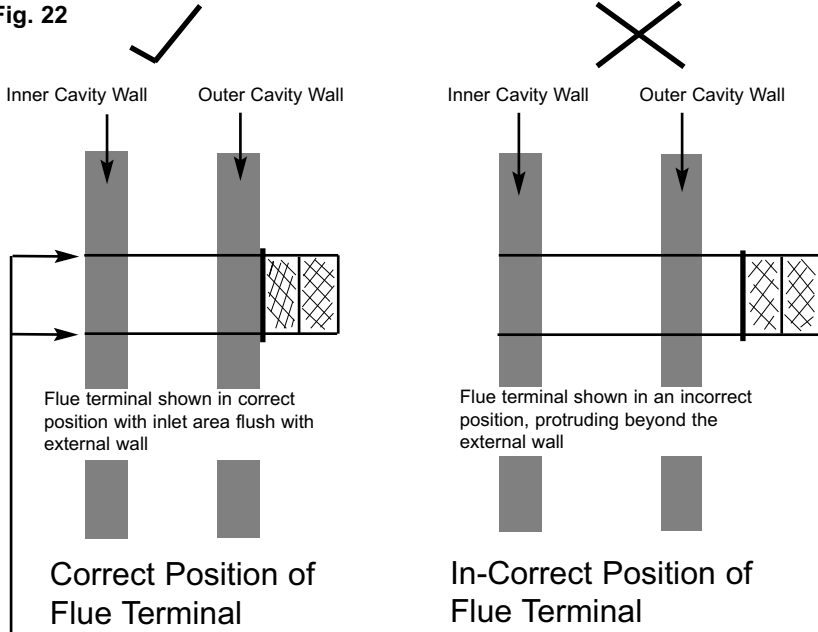

Ensure flue pipes are sealed at point of entry to cavity wall

2.11 FITTING THE TERMINAL GUARD

With the flue terminal in position, place the terminal guard over the top of the flue terminal and mark the position of the holes on the outer wall. Remove the terminal guard and drill the 4 off 6 mm holes. Insert the raw plugs into the drilled holes, replace the terminal guard over the top of the flue terminal and attach to the wall using the No.12 x 40mm screws provided with the terminal guard. See Fig. 23 below.

Fig. 23



NOTE: In England & Wales, the building regulations require that a terminal guard should be fitted if the terminal could come into contact with people near the building or be subject to damage. BFM Europe Ltd. also recommend the fitting of a flue terminal guard where regulations do not demand that it be fitted. A suitable flue terminal guard is supplied with the appliance.

2.12 REMOVING / RE-FITTING THE GLASS FRAME ASSEMBLY

- a) The glass frame is held in position by hooking the top flange over the combustion chamber opening at the top as shown in Fig. 24 below.

Fig. 24

Glass Frame Assembly locates over lip on top of combustion chamber lid, and drops onto flange as shown. To remove, unclip base clips as shown in Fig. 20 and lift clear.

--- denotes correct final position of glass frame.

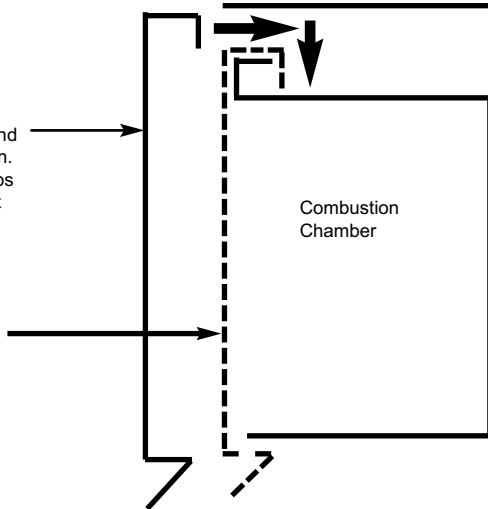

- b) The assembly is then secured to the bottom of the combustion chamber by the two hinge clamp brackets as shown below in Fig. 25. These are clamped together to form the seal between the glass frame assembly and the combustion chamber.

Fig. 25

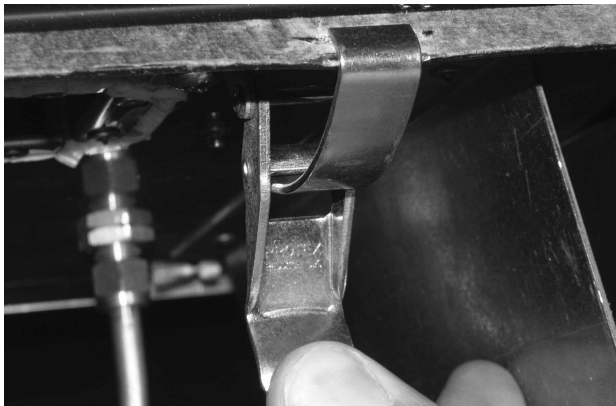

NOTE : Always ensure that a consistent seal between the combustion chamber and the glass frame is achieved.

SECTION 3 INSTALLATION OF FIRE

3.1 FITTING THE FUEL-BED LOGSET

- a) The gravel material should then be first layed around the base of the combustion chamber as shown below in Fig. 26, leaving the rear section as shown to allow the fitting of Log “A”

Fig. 26



- b) Place the largest Log “A” centrally onto the fuel-bed support behind the burner flame strip. Ensure that the fuel-bed Log “A” is located centrally in the firebox, and that the front edge is parallel with the rear face of the burner flame strip as shown below in Fig. 27.

Fig. 27



- c) Fit Log “B” into position on left hand side of the fuel-bed base log “A” as shown below in Fig. 28, using the groove in Log “A” as a guide for placement.

Fig. 28

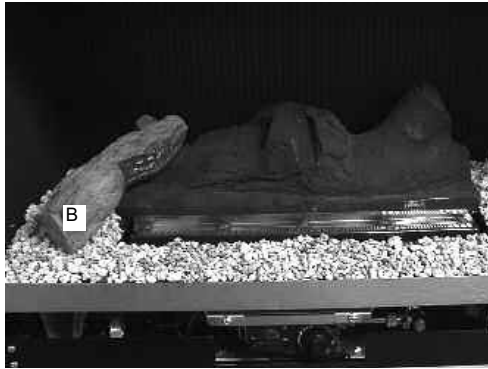

- d) Fit Log “C” into position on left hand side of the fuel-bed base log “A” as shown below in Fig. 29, using the groove in Log “A” as a guide for placement.

Fig. 29



- d) Fit Log “D” into position on left hand side of the fuel-bed base log “A” as shown below in Fig. 30, using the groove in Log “A” as a guide for placement.

Fig. 30



- e) Fit Log “E” into position at centre of the fuel-bed base log “A” as shown below in Fig. 31, using the groove in the centre of Log “A” as a guide for placement.

Fig. 31

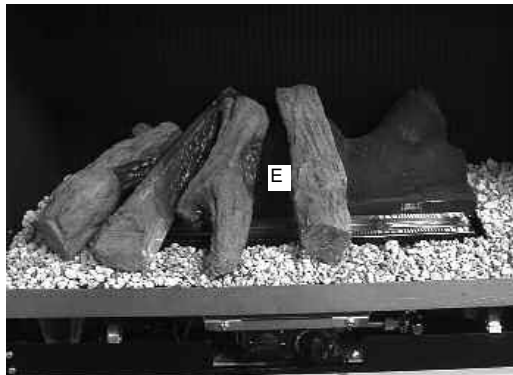

- f) Fit Log “F” into position at right hand side of centre of the fuel-bed base log “A” as shown below in Fig. 32, using the groove in Log “A” as a guide for placement.

Fig. 32



- g) Fit Log “G” into position at right hand side of the fuel-bed base log “A” as shown below in Fig. 33, using the raised section in the base log as a guide for position.

Fig. 33



IMPORTANT NOTE

HAVING FITTED THE GRAVEL MATERIAL IN THE BASE OF THE COMBUSTION CHAMBER, ENSURE THAT NONE OF IT IS ON THE BURNER FLAME STRIP OR IN THE PILOT ASSEMBLY. IF MATERIAL IS OBSERVED VISUALLY ON THESE COMPONENTS, REMOVE THE FUEL-BED LOGSET, REMOVE THE GRAVEL MATERIAL FROM THE BURNER AND OR PILOT AND RE-FIT THE LOGS AS DETAILED IN SECTION 3.1 ABOVE.

Warning : Use only the logs supplied with the fire. When replacing the logs remove the old logs and discard them. Fit a complete set of logs of the correct type. Do not fit additional logs or any logs other than a genuine replacement set.

To ensure that the release of fibres from these R.C.F (Refractory Ceramic Fibre) articles is kept to a minimum, during installation and servicing we recommend that you use a HEPA filtered vacuum to remove any dust accumulated in and around the appliance before and after working on the appliance. When replacing these articles we recommend that the replaced items are not broken up, but are sealed within heavy duty polythene bags, clearly labelled as "RCF waste". RCF waste is classed as a "stable", non reactive hazardous waste and may be disposed of at a landfill licensed to accept such waste. Protective clothing is not required when handling these articles, but we recommend you follow the normal hygiene rules of not smoking, eating or drinking in the work area, and always wash your hands before eating or drinking.

This appliance does not contain any component manufactured from asbestos or asbestos related products.

Refit the glass frame as detailed in section 2.13 (page 21), then light the appliance as detailed in section 3.3

3.2 MAKING THE GAS CONNECTION & CHECKING FOR GAS TIGHTNESS

- a) Before making the final gas connection, thoroughly purge the gas supply pipework to remove all foreign matter, otherwise serious damage may be caused to the gas control valve on the fire. Failure to purge the gas supply will invalidate the guarantee.
- b) The gas connection should be made to the appliance inlet elbow to using 8mm rigid tubing.
- c) Remove the pressure test point screw from the inlet elbow and fit a manometer.
- d) Turn on the main gas supply and carry out a gas tightness test.

3.3 LIGHTING THE APPLIANCE

IMPORTANT : IF THE BURNER IS EXTINGUISHED FOR ANY REASON YOU MUST ENSURE THAT YOU WAIT A FULL FIVE MINUTES BEFORE ATTEMPTING TO RE-LIGHT THE FIRE.

Fig. 34

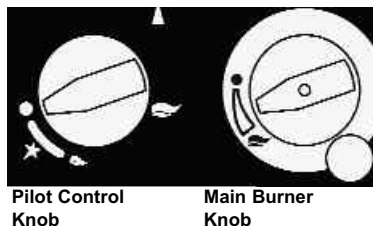

- a) Locate the control valve on the appliance, it is situated below the combustion chamber in the centre. There are two control knobs on the appliance, the left control knob controls the pilot ignition, the right hand control knob controls the main burner. This appliance is designed to run with the pilot permanently running, and the remote control can then be used to light the main burner, and control the gas rate between high and low. See Fig. 34 above for layout of controls.
- b) Depress the left control knob and rotate it anti-clockwise to the position marked pilot. (a click will be heard). Hold in the control knob for a few seconds whilst the air is purged from the supply pipe. Bring the knob back to its start position and turn it several times to the pilot position. The pilot should light. Hold in the control knob for at least 10 seconds to allow the thermocouple to heat up. Release the control knob. If the pilot fails to light, repeat the procedure as detailed above.
- c) Turn the left hand control anticlockwise to the large flame position and this allows the gas flow to enter the main burner section of the control valve. The main burner can then be controlled either manually or by the remote control handset.

To adjust the heat input manually :-

With the pilot lit as detailed in section c) turn the right hand control knob anticlockwise past the large flame position. This allows gas to enter the main burner and be ignited by the pilot flame. Once the main burner has been lit, the right hand control knob can be adjusted to any position between the large flame (7.5kW heat input) position and the small flame (3.5kW heat input) position.

To adjust the heat input via the remote handset :-

Press the “up” button to light the main burner and adjust the heat input to the maximum setting. (7.5kW heat input). Press the “down” button to reduce the heat input to the minimum setting (3.5kW heat input). See Fig. 35 below.

Fig. 35

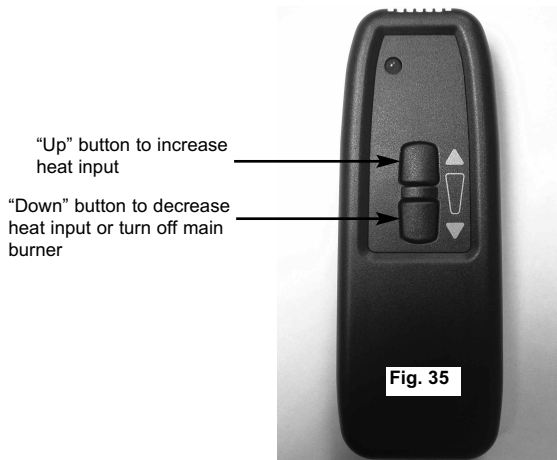

NOTE : The remote control does not light the pilot, it only lights the main burner when the pilot flame is established and regulates the heat input between high and low.

- d) Check that the gas pressure is 20.0 mbar (+/- 1.0mbar) 8.0 in w.g.(+/- 0.4 in w.g.) with the main burner operating on “high”.

To turn off the main burner :-

- e) Turn right hand control knob clockwise to the position marked ● or press the down button on the remote handset until the flame extinguishes, at this point a clicking noise will be heard from the motor.

To turn off the pilot flame :-

- f) Turn left hand control knob clockwise to the position marked ● and the pilot flame will extinguish.
- g) After ensuring that the fire is safe to use it should be left on high position to fully warm up. During this time a slight odour may be

noticed, this is due to the “newness” of the fire and will soon disappear.

AFTER THE PILOT FLAME HAS BEEN EXTINGUISHED, IF YOU WISH TO RE-LIGHT THE APPLIANCE YOU MUST WAIT AT LEAST FIVE MINUTES BEFORE TRYING TO RE-LIGHT THE APPLIANCE.

Finally, hand the Installation and Maintenance Instructions and the Users Instructions over to the customer and explain the operation of the fire.

NOTE : THIS APPLIANCE IS DESIGNED TO WORK SAFELY AND EFFECTIVELY DURING ADVERSE WEATHER CONDITIONS. HOWEVER, DURING SUCH TIMES FLAME DISTURBANCE MAY BE NOTICED. THIS IS NORMAL AND DOES NOT EFFECT OR IMPAIR THE SAFETY OF THE APPLIANCE.

3.4 REMOVAL & RE-FITTING OF THE TRIM ASSEMBLY

- a) The trim is attached to firebox by 4 off magnets as shown below in figure 36.

Fig. 36

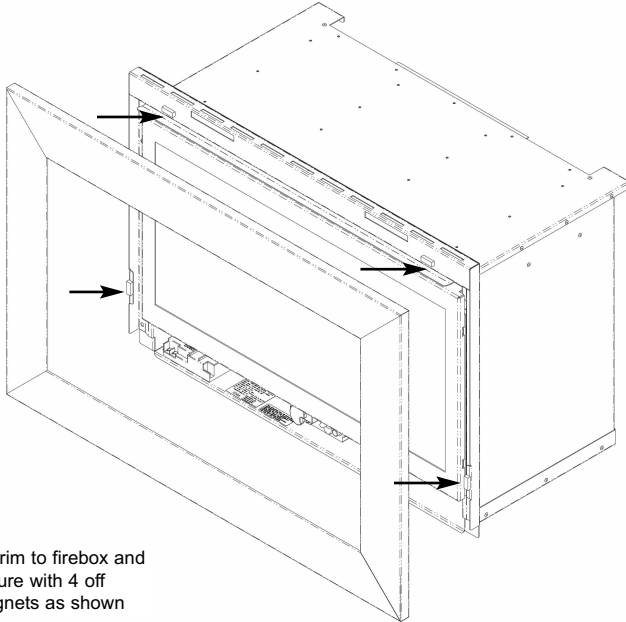

- b) Ensure the trim is securely fitted to the fire.

SECTION 4 MAINTENANCE

Servicing Notes

Servicing should be carried out annually by a competent person such as a GAS SAFE registered engineer. It is a condition of Flavel Firesguarantee scheme that this is carried out by a competent person i.e a GAS SAFE registered Engineer in accordance with these servicing notes.

The condition of the logs should be checked and if necessary the whole set should be replaced with a genuine replacement set.

After any servicing work a gas tightness check must always be carried out.

During the annual service, the flue pipe seals should be inspected and replaced as necessary.

4.1 Removing the burner assembly from the fire.

- 4.1.1 Isolate the gas supply.
- 4.1.2 Remove trim from the front of the fire, as shown in section 3.4
- 4.1.3 Remove the glass frame assembly from the fire, as shown in section 2.11.
- 4.1.4 Remove the log set and loose gravel from the combustion chamber base, taking care not to damage the logs.
- 4.1.5 Remove the access panel from the front of the combustion chamber, which is secured using two screws.
- 4.1.6 Remove the two burner retaining screws, 1 at each end of the burner.
- 4.1.7 Slide the burner off the main injector and remove from the product.

4.2 Removing the Control Valve from the fire.

- 4.2.1 Isolate the gas supply.
- 4.2.1 Remove trim from the front of the fire, as shown in section 3.4
- 4.2.2 Disconnect the pipe to the bulkhead fitting on the valve and disconnect the pipe on the valve which runs to the inlet elbow.

- 4.2.3 Loosen the pilot pipe, disconnect the ignition lead from the electrode and disconnect the thermocouple from the pilot assembly.
- 4.2.5 Remove the 2 off fixing screws which hold the valve mounting plate to its mounting bracket and lift the valve and its mounting plate away from the combustion chamber.
- 4.2.6 Swap the valve mounting plate onto the new valve by unscrewing the two M5 nuts and bolts holding it in position .
- 4.2.7 Re-assemble with new valve in reverse order.

4.3 Removing the Ultrasonic receiver.

- 4.3.1 Dis-connect the two pin plug which runs from the bottom right hand side of the control valve to the ultrasonic receiver.
- 4.3.2 Lift the ultrasoic receiver out of its mounting cradle (attached to the L/H leg of the combustion chamber).
- 4.3.3 Re-fit the new receiver in its cradle and re-fit the control wires to the bottom R/H side of the control valve.

4.4 Removing the Pilot Assembly

- 4.4.1 Isolate the gas supply
- 4.4.2 Remove trim from the front of the fire, as shown in section 3.4
- 4.4.3 Remove the glass frame assembly from the fire, as shown in section 2.11.
- 4.4.4 Remove the log set and loose gravel from the combustion chamber base, taking care not to damage the logs.
- 4.4.5 Remove the access panel from the front of the combustion chamber, which is secured using two screws.
- 4.4.3 Loosen the pilot pipe, disconnect the ignition lead from the electrode, and remove the thermocouple from the pilot body.
- 4.4.4 Remove the two fixing screws which secure the pilot assembly to the pilot mounting panel in the base of the combustion chamber.
- 4.4.5 Remove the pilot assembly.

4.4.6 Re-assemble with an new pilot assembly, and gasket, ensuring than an even seal around the pilot assembly is obtained. Carry out a gas tightness test after re-assembly.

4.5 Replacing the Batteries in the Ultrasonic Receiver

4.5.1 Remove the ultrasonic receiver as described in section 4.3

4.5.2 Remove the rear cover of the ultrasonic receiver and remove the 4 off AA sized batteries, replace with new item and refit in reverse order.

4.6 Replacing the Batteries in the Handset

4.6.1 Remove and re-fit the new 9V battery by removing the cover on the back of the handset.

Parts Shortlist

Control Valve	B-82290	Pilot Body	70-36250
Thermocouple	70-36270	Pilot Gasket	70-35220
Glass Panel	B-81190	Glass Seal	B-84180
Ignition Electrode	70-36290		
Remote Control & Receiver	B-82350		
Complete Log Set	B-109780		
Log "A"	B-109700	Log "D"	B-109730
Log "B"	B-109710	Log "E"	B-109740
Log "C"	B-109720	Log "F"	B-109750
Log "G"	B-109760		

Due to our policy of continual improvement and development the exact accuracy of illustrations and descriptions contained in this book cannot be guaranteed.

Part No. B-1004399
Issue 1



At the heart of your home

BFM Europe Ltd.
Trentham Lakes
Stoke-on-Trent
Staffordshire
ST4 4TJ
www.bfm-europe.com

Telephone - General Enquiries : (01782) 339000
Telephone - Service : (01782) 339008