



At the heart of your home

Jazz HE

Model No. FHCL**RN

HIGH EFFICIENCY LOG EFFECT ROOM HEATER

Installation, Maintenance & User Instructions

Hand these instructions to the user

Model No. FHCLRN is for use on Natural Gas (G20) at a supply pressure of 20 mbar in G.B. / I.E.**

**** Denotes trim & colour variant**

Information Requirements for Commission Regulation (EU) 2015/1188

Model Identifier	FHCL**RN
Indirect Heating Functionality	No
Direct Heat Output	3.2kW
Indirect Heat Output	Not Applicable
Fuel	Natural Gas (G20)
NOx Emissions	130mg/kWh
Nominal Heat Output	3.2kW
Minimum Heat Output (Indicative, all models)	1.6kW
Useful Efficiency at Nominal Heat Output	81.4%
Useful Efficiency at Minimum Heat Output (Indicative)	50.0%
Auxilliary Power Consumption at Nominal Heat Output	0.000008kW
Auxilliary Power Consumption at Minimum Output	0.000008kW
Auxilliary Power Consumption at Standby Mode	0.000008kW
Permanent Pilot Flame Requirement	0.14Kw
Type of Heat Output / Room Temperature Control	With electronic room temperature control plus day timer.
Contact Details	BFM Europe Ltd. Gordon Banks Drive Trentham Lakes North Stoke-on-Trent ST4 4TJ Tel : 01782 339000

CONTENTS

	PAGE
Section 1 Information and Requirements	
1.0 Appliance information	3
1.1 Conditions of installation	4
1.2 Flue & Chimney Suitability	4
1.3 Shelf position	5
1.4 Hearths	5
1.5 Installation to plastered wall surfaces	5
Section 2 Installation of Fire	
2.1 Unpacking the combustion chamber	6
2.2 Preparing the combustion chamber opening (In studded wall)	7
2.3 Preparing the combustion chamber opening (In chimney breast)	8-9
2.4 Securing the fire to the opening	10
2.5 Installation of the gas supply	11
2.6 Fitting the efficiency / flue restrictor baffle	12
2.7 Fitting the batteries to the fire	12
2.8 Removal & re-fitting of the glass frame	13
Section 3 Assembling Fuel Bed and Commissioning	
3.1 Fitting the fuel bed logset	14-18
3.2 Making the gas connection & checking for gas tightness	18
3.3 Removal & re-fitting the trim	19
3.4 Lighting the appliance - SIT RC system equipped models	20-25
3.5 Lighting the appliance - Mertik Maxitrol system equipped models	26-30
3.6 Checking for clearance of combustion products	31
Section 4 Maintenance	
4.1 Removal of the burner assembly	32
4.2 Removal of the control valve	32-33
4.3 Removal of the ultrasonic reciever	33
4.4 Removal of the pilot assembly	33
4.5 Removal / Replacement of the control board	33
4.6 Removal / Replacement of the handset battery	34
Section 5 User Instructions	
5.1 Installation Information	35
5.2 About the Jazz HE room heater	36
5.3 Spillage monitoring system	37
5.4 Lighting the appliance - SIT RC system equipped models	38-43
5.5 Lighting the appliance - Mertik Maxitrol system equipped models	44-48
5.6 Cleaning Instructions	49
5.7 Removal & re-fitting the fuel-bed logset	50-53
5.8 Removal & re-fitting the glass frame	54
5.9 Removal & re-fitting the trim assembly	55
5.10 User replaceable parts	56
5.11 Changing the batteries in the RC handset	56
5.12 Changing the batteries in the fire	56

Model number FHCLRN** manufactured by:-

BFM Europe Ltd. Trentham Lakes, Stoke-on-Trent, Staffordshire, ST4 4TJ

SECTION 1 INFORMATION AND REQUIREMENTS

1.0 APPLIANCE INFORMATION

Main injector : (1 off)	Stereomatic Injector Cat 82 – size 320 (NG)
Pilot Type :	Copreci ODS 21100 / 162 (SIT RC System) Copreci ODS 21100 / 141 (Mertik Maxitrol RC system)
Max. Gross Heat Input :	4.4kW
Min. Gross Heat Input :	3.1kW
Gas Rate :	0.421 m ³ /hr (High) 0.293 m ³ /hr (Low)
Cold Pressure :	G20 20.0+/-1.0 mbar (8.0 +/- 0.4 in w.g.)
Ignition :	Integral to gas valve
Electrode Spark Gap :	4.0mm
Packed Weight Combustion Chamber	49.0 kg

Appliance Efficiency Declaration

The efficiency of this appliance has been measured as specified in BS EN 7977-1 : 2002 and the result is 79%. The gross calorific value of the fuel has been used for this efficiency calculation. The test data from which it has been calculated has been certified by GL Industrial Services UK Ltd. The efficiency value may be used in the UK Government's Standard Assessment Procedure (SAP) for energy rating of dwellings.

Fig. 1

Top View of Combustion Chamber

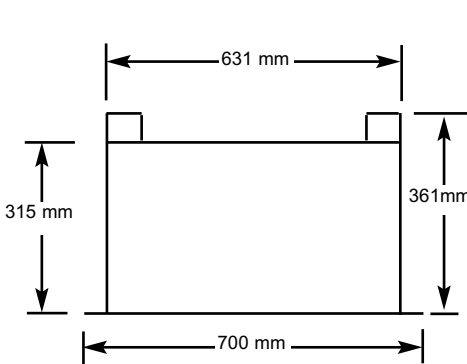
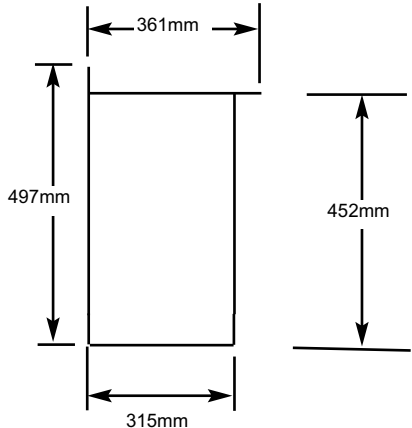

Fig. 2

Side View of Combustion Chamber



INSTALLATION REQUIREMENTS

1.1 CONDITIONS OF INSTALLATION

It is the law that all gas appliances are installed only by a GAS SAFE Registered Installer, in accordance with these installation instructions and the Gas Safety (Installation and Use) Regulations 1998 as amended. Failure to install appliances correctly could lead to prosecution. It is in your own interest and that of safety to comply with the law. The installation must also be in accordance with all relevant parts of the Local and National Building Regulations where appropriate, the Building Regulations (Scotland Consolidation) issued by the Scottish Development Department, and all applicable requirements of the following British Standard Code of Practice.

1. BS 5871 Part 2 Installation of Inset Live Fuel Effect Gas Fires
2. BS 6891 Installation of Gas Pipework
3. BS 5440 Parts 1 & 2 Installation of Flues and Ventilation
4. BS 1251 Open fire place components
5. BS 715 / BS EN 1856-2 Metal flue pipes for gas appliances
6. BS EN 1858 Clay Flue Blocks and Terminals
7. IS 813 : Domestic Gas Installation (Republic of Ireland)

No purpose made additional ventilation is normally required for this appliance, when installed in G.B. When installing in I.E. please consult document I.S. 813 : Domestic Gas Installation, which is issued by the National Standards Authority of Ireland. If installing in Northern Ireland, please consult local building regulations. Any purpose made ventilation must be checked periodically to ensure that it is free from obstruction.

1.2 FLUE AND CHIMNEY SUITABILITY

This appliance is designed for use with conventional brick built or lined chimneys and fabricated flues and metal flue boxes conforming to BS 715 / BS EN 1856-2. All flues must conform to the following minimum dimensions.

Minimum diameter of circular flues	125 mm
Minimum effective height of all Class 1 (175mm) flues	3 metres
Minimum effective height of all Class 2 (125mm) flues	4 metres

ENSURE THAT IF INSTALLING THIS PRODUCT INTO A BRICK BUILT CHIMNEY, THE CHIMNEY HAS BEEN FULLY SWEEPED PRIOR TO PROCEEDING WITH THE INSTALLATION.

Safe clearance of products must always be checked by carrying out a smoke match test as described in section 3.7

1.3 SHELF POSITION

The fire may be fitted below a combustible shelf providing there is a minimum distance of 300mm above the top of the fire and the shelf does not project more than 150mm. If the shelf overhangs more than 150mm the distance between the fire and the shelf must be increased by 15mm for every 25mm of additional overhang over 150mm.

1.4 HEARTHES

This appliance does not require the fitting of a hearth that projects in front of it when installed into a recess in either an existing chimney breast or a studded wall. The appliance must however stand on a non-combustible base that is a minimum thickness of 12mm

1.5 INSTALLATION TO PLASTERED WALL SURFACES

If installing to a plastered wall, all material must be removed from the 50mm area surrounding the combustion chamber opening, and replaced with non-combustible material, such as marble or granite, to prevent plaster cracking. See figure 3 below.

Fig. 3

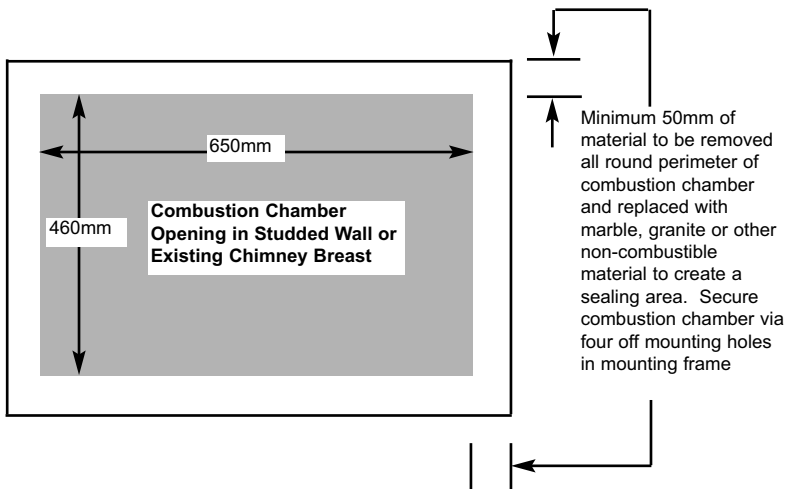

SECTION 2 INSTALLATION OF FIRE

2.1 UNPACKING THE COMBUSTION CHAMBER

Carefully lift the combustion chamber out of the carton. Remove the loose item packaging carefully from the pack. Check the contents as listed :-

DO NOT UNDER ANY CIRCUMSTANCES USE THIS APPLIANCE IF THE GLASS PANEL IS BROKEN OR NOT SECURELY FIXED TO THE FIREBOX.

Packing Check List

- | | | |
|-------|--|---|
| 1 off | Combustion Chamber & Glass Frame Assembly | |
| 1 off | Trim (packed in seperate box) | |
| 1 off | Boxed ceramic fuel-bed set (packed inside combustion chamber) | |
| 1 off | Installation / User Instruction Manual | |
| 1 off | Rubber grommet (to seal inlet aperture used on firebox) | |
| 1 off | Handset & 1 off 9V Battery or 3 off AAA Batteries (dependent upon RC system) | |
| 1 off | Loose Items pack – containing :- | 1 off Efficiency Baffle plus 4 off fixing screws |
| | | 4 off No. 12 x 40mm Screws |
| | | 4 off Rawlplugs |
| | | 4 or 6 off AA Batteries (dependent upon RC system) |
| | | 1 off handset wall bracket (dependent upon RC system) |

IMPORTANT NOTE BEFORE PROCEEDING WITH THE INSTALLATION

This product requires a minimum effective flue height of 4.0 metres of minimum circular cross-sectional area 125mm. If installing the product into a 225mm x 225mm brick chimney, THE CHIMNEY SOUNDNESS MUST BE CHECKED BY TESTING prior to a decision being made on whether the chimney requires lining. If the flue height is greater than 10 metres on an external wall or 12 metres on an internal wall then a flue liner must be fitted even if the chimney integrity is ok.

Please check the chimney height and integrity prior to proceeding with the installation, to establish if a chimney liner is required. Any flue pipe should conform to BS 715 / BS EN 1856-2 (Metal flue pipes for gas appliances).

When you have decided upon if the product requires the fitting of a flue liner, proceed with the creation of the correct sized builders opening or studwork installation of the product as per sections 2.2 or 2.3

2.2 PREPARATION OF THE COMBUSTION CHAMBER OPENING (INTO STUDDED WALL) USING A 125MM FLUE LINER.

All combustible parts of the studwork must be set at the distances as shown below in figure 4 & 5. For installation into such applications a flue box with 125mm flue pipe adaptor is available to purchase as a cost option extra, please order part number 1125-133710, from your local Flavel stockist.

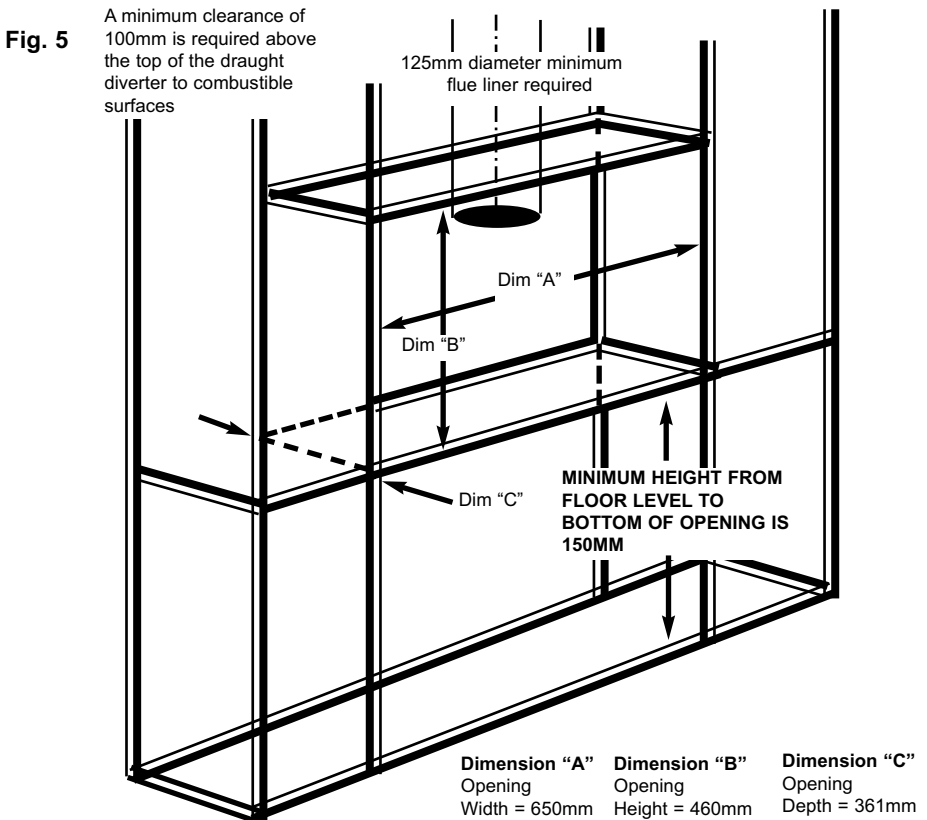
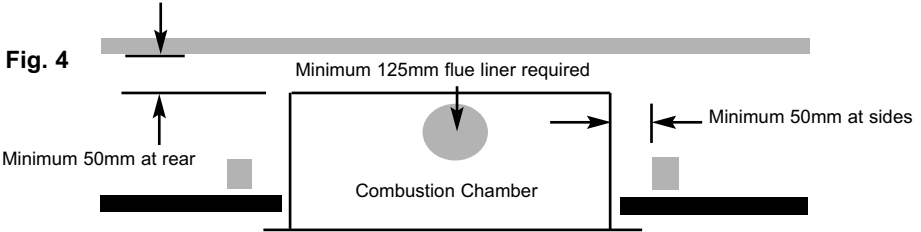

2.3 PREPARATION OF THE COMBUSTION CHAMBER OPENING (INTO EXISTING CHIMNEY BREAST)

An opening should be constructed to the following dimensions in the existing chimney breast. See figure 6 below.

Fig. 6

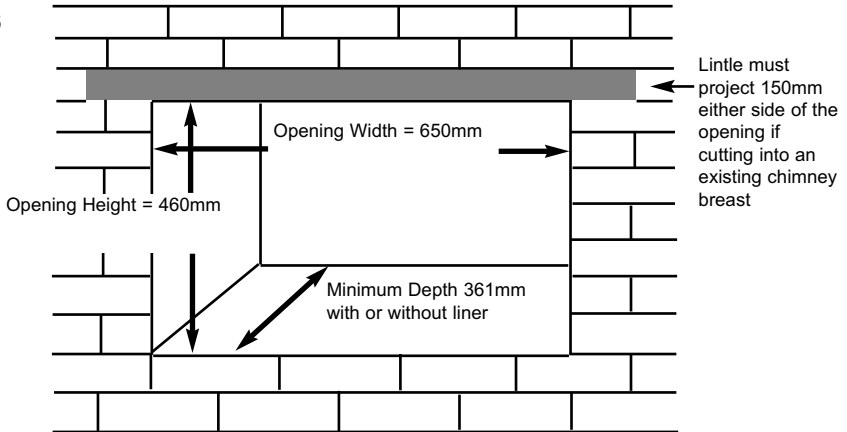

NOTE : Please ensure that access holes are cut into either the sides or area above the lintel to allow access to the flue pipe connection if using a flue liner. Such access holes are also advantageous in installations where a flue liner is not required as they provide access for servicing purposes.

If installing without a flue liner, please ensure that sufficient depth is available in the opening to collect a minimum volumetric area of 12 litres (0.012m^3) of flue debris. This is achieved by a minimum depth of 361mm, the design of the outer combustion chamber ensures this depth can be met.

Refer to figure 1 on page three for dimensions of the flue outlet.

CHECK ANY LOAD BEARING STRUCTURAL ITEMS ARE NOT AFFECTED BY THE INSTALLATION OF THE PRODUCT. SEE FIG 6 OVERPAGE.

Fig. 7

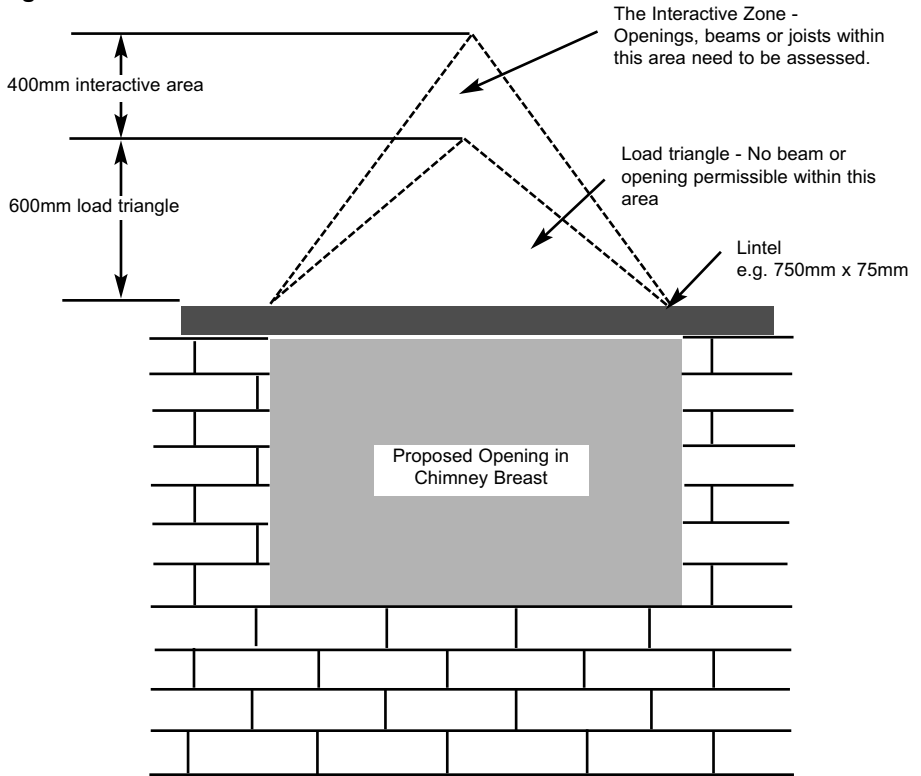

The opening needs to be sufficient to accommodate the combustion chamber. To support the wall above the opening, a suitable lintel must be inserted across the top of the opening. The lintel could be either pre-cast concrete or steel - Catnic CN52 or CN 46 could be used, depending upon the inner wall thickness. Before proceeding with the installation of the fire, an assessment of the area immediately above the fire is required, see figure 7 above. If there is no existing openings within either triangle, proceed with forming the opening. However, if openings or beams occur within either triangle, then you should seek specialist advice from a structural engineer or consider relocating the proposed position of the firebox.

2.4 SECURING THE FIRE TO THE OPENING

- 2.4.1 The combustion chamber must be secured to the opening via the four off screw and rawlplugs provided. Figure 8 & 9 below shows the hole centres in the mounting flanges of the combustion chamber.

Fig. 8

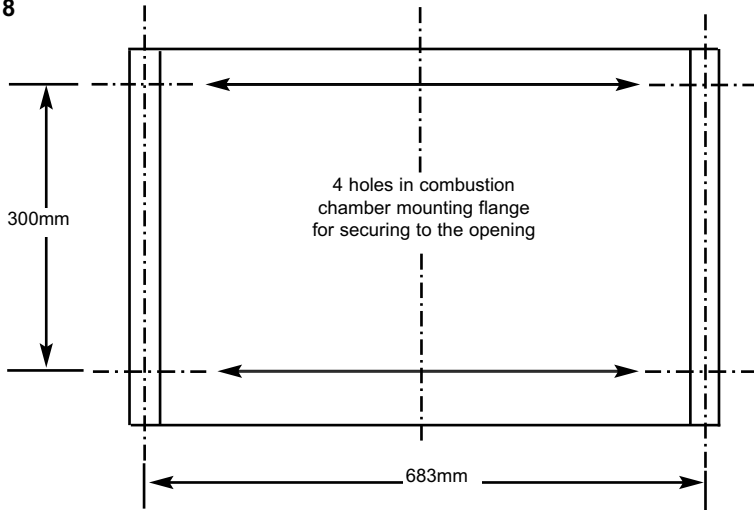

- 2.4.2 DO NOT SECURE THE COMBUSTION CHAMBER INTO THE OPENING AT THIS POINT AS ACCESS WILL STILL BE REQUIRED TO RUN THE GAS SUPPLY PIPEWORK AS DETAILED IN SECTION 2.5

Fig. 9

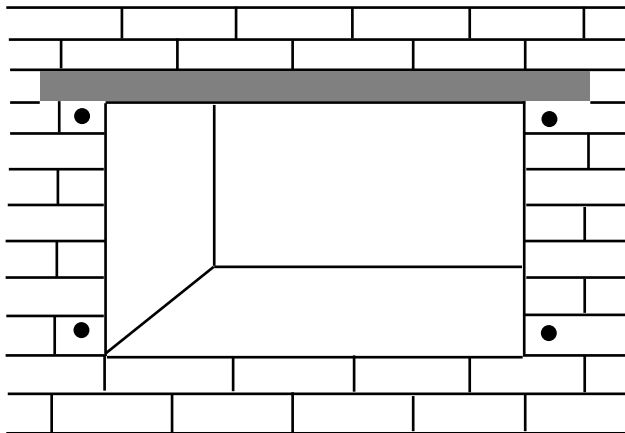

2.5 INSTALLATION OF THE GAS SUPPLY (INTO STUDDED WALL OR EXISTING CHIMNEY BREAST)

Before installing the combustion chamber, decide from which side or if a rear connection to the gas supply is required. Plan the pipe run to enter the below the firebox from the left, right or rear and connect to the inlet elbow. See figure 10, 11 & 12 below.

Note : Before breaking into the gas supply a pressure drop test should be carried out to establish that the existing pipework is sound. Always insert the grommet into the entry point used (a sharp blow with a hammer or chisel will be sufficient to knock out the opening selected in the firebox) and with the grommet fitted cut with a sharp knife to allow the supply pipework to pass through into the firebox.

Fig. 10

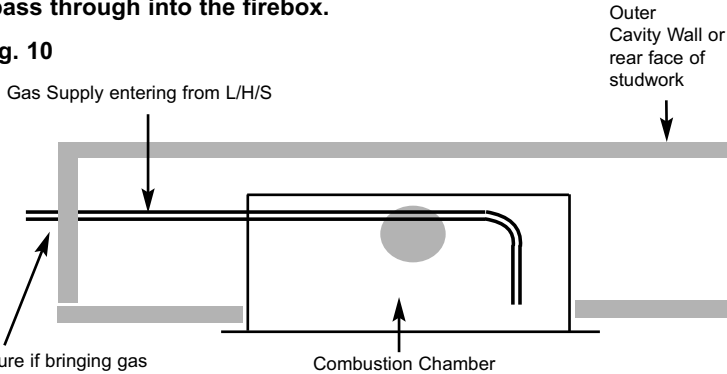

Ensure if bringing gas supply through side or rear of a chimney breast that the pipe is sleeved and sealed with a suitable flexible, non setting compound

Fig. 11

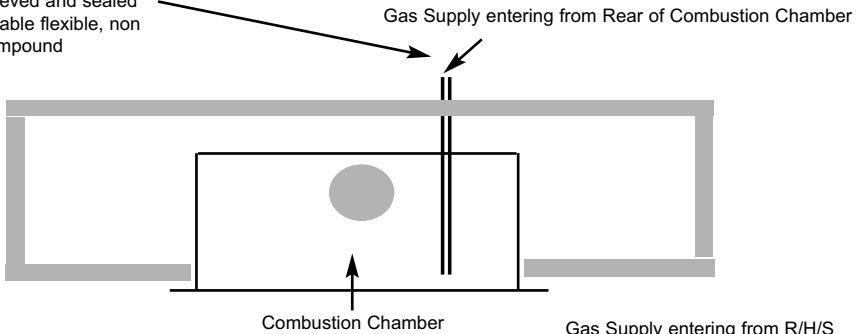
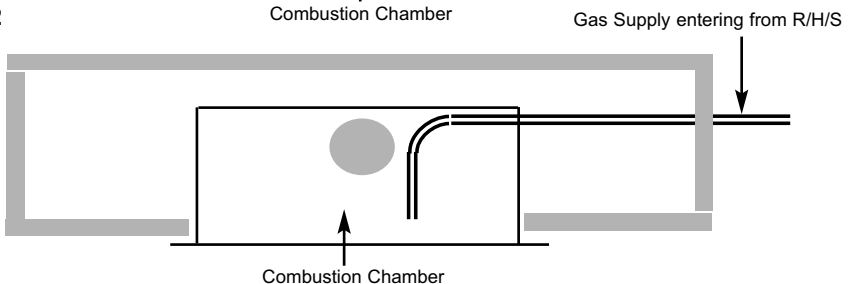

Fig. 12



2.6 FITTING OF THE EFFICIENCY BAFFLE.

- 2.6.1 The product is supplied with an efficiency baffle to improve the efficiency of the product when installed into Class 1 flues, of minimum diameter 175mm / 7" or brick built 225mm x 225mm chimneys. The minimum effective height of all flues must be 3 metres or above.
- 2.6.2 If the product is to be fitted into a Class 1 flue, it may be desirable to fit the efficiency baffle.
- 2.6.3 If the product is fitted into a Class 2 flue of diameter 125mm / 5" then the restrictor baffle must not be fitted. It should also be noted that if fitting into a 125mm / 5" diameter flue that the minimum effective height of the flue is 4 metres.
- 2.6.4 To fit the efficiency baffle (supplied in the loose items pack), use the 4 screws supplied to secure the baffle to the spigot on the rear of the firebox as shown below in figure 13.

Fig. 13

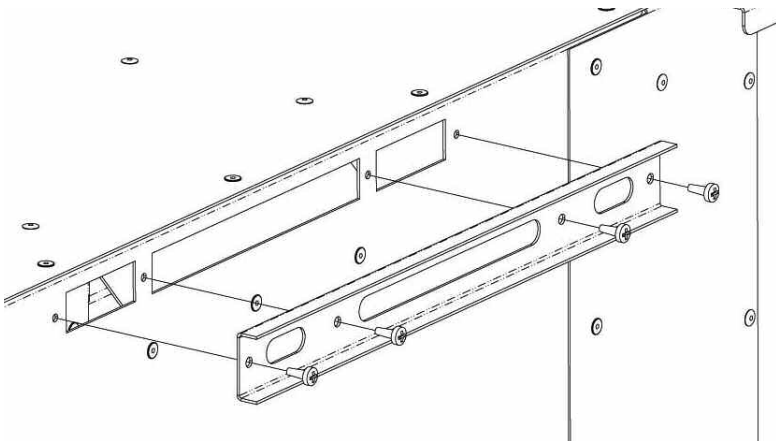

2.7 FITTING OF THE BATTERIES

- 2.7.1 The battery pack on SIT equipped models is at the front of the product in the centre. Fit the 6 off AA batteries supplied.
- 2.7.2 The batteries on the Mertik Maxitrol equipped models are on the left hand side, in the receiver unit. Slide the cover off and replace with 4 off AA batteries.

2.8 REMOVING / RE-FITTING THE GLASS FRAME ASSEMBLY

2.8.1 The glass frame is held in position by hooking the top flange over the combustion chamber opening at the top as shown in figure 14 below.

Fig. 14

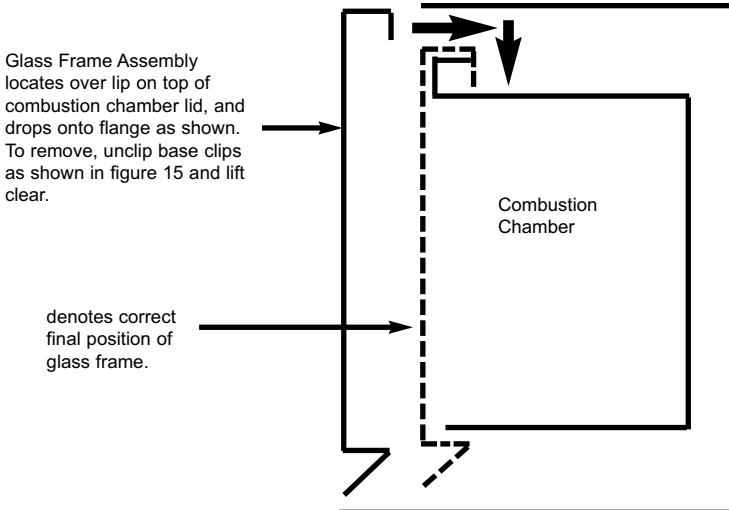

2.8.2 The assembly is then secured to the bottom of the combustion chamber by the two hinge clamp brackets as shown below in figure 15. These are clamped together to form the seal between the glass frame assembly and the combustion chamber.

Fig. 15

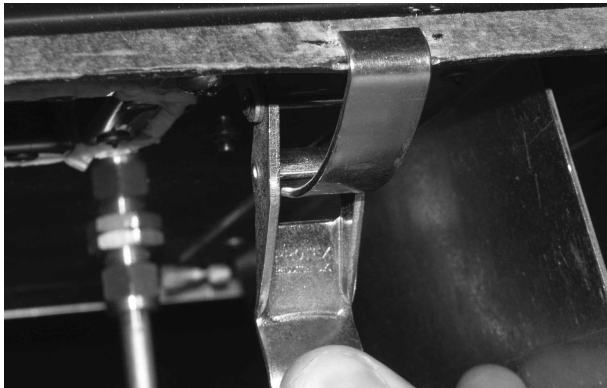

NOTE : Always ensure that a consistent seal between the combustion chamber and the glass frame is achieved.

SECTION 3 INSTALLATION OF FIRE

3.1 FITTING THE FUEL-BED LOGSET

- 3.1.1 The gravel material should be first layed around the base of the combustion chamber as shown below in figure 16, leaving the rear section as shown to allow the fitting of Log "A". Where the cut outs are located in the base section gravel material should be left clear of these aperatures until the log set is fully fitted.

Fig. 16



- 3.1.2 Place the largest Log "A" centrally onto the fuel-bed support behind the burner flame strip. Ensure that the fuel-bed Log "A" is located centrally in the firebox, and that the front edge is parallel with the rear face of the burner flame strip as shown below in figure 17.

Fig. 17

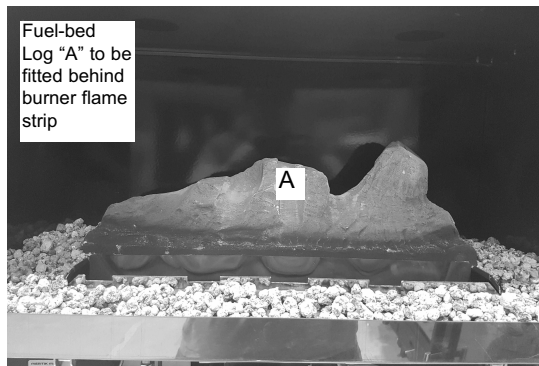

- 3.1.3 Fit Log “B” into position on right hand side of the fuel-bed base log “A” as shown below in figure 18, using the groove in Log “A” as a guide for placement, and locate the slot of the fork in the log into the cut-out of the base plate.

Fig. 18

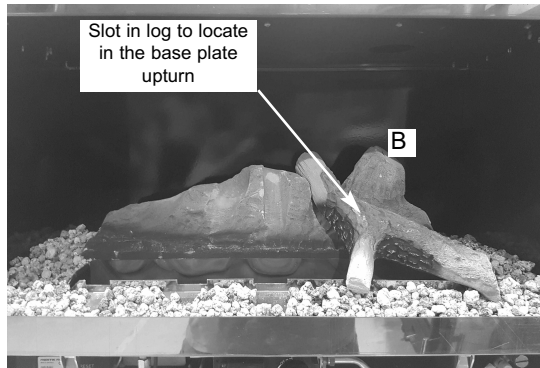

- 3.1.4 Fit Log “C” into position in the centre right side of the fuel-bed base log “A” as shown below in figure 19, using the groove in Log “A” as a guide for placement, and locate the slot in the log into the cut-out of the base plate.

Fig. 19

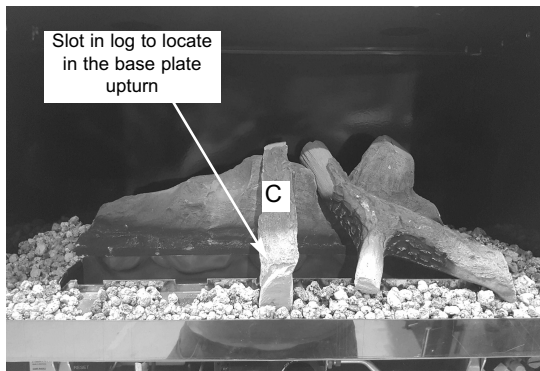

- 3.1.5 Fit Log “D” into position on centre left of the fuel-bed base log “A” as shown below in figure 20, using the groove in Log “A” as a guide for placement, and locate the log into the cut-out of the base plate.

Fig. 20

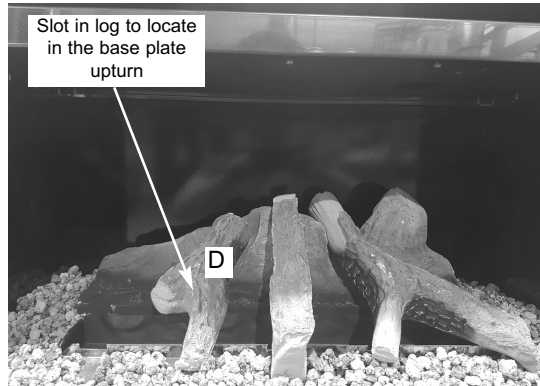

- 3.1.6 Fit Log “E” into position at left hand side of the fuel-bed base log “A” as shown below in figure 21, using the groove in the centre of Log “A” and locate the log slot into the cut-out in the base plate.

Fig. 21

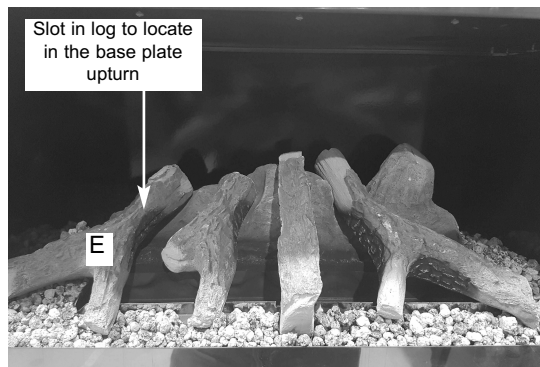

IMPORTANT NOTE

HAVING FITTED THE GRAVEL MATERIAL IN THE BASE OF THE COMBUSTION CHAMBER, ENSURE THAT NONE OF IT IS ON THE BURNER FLAME STRIP OR IN THE PILOT ASSEMBLY. IF MATERIAL IS OBSERVED VISUALLY ON THESE COMPONENTS, REMOVE THE FUEL-BED LOGSET, REMOVE THE GRAVEL MATERIAL FROM THE BURNER AND OR PILOT AND RE-FIT THE LOGS AS DETAILED IN SECTION 3.1 ABOVE.

Warning : Use only the logs supplied with the fire. When replacing the logs remove the old logs and discard them. Fit a complete set of logs of the correct type. Do not fit additional logs or any logs other than a genuine replacement set.

This appliance uses fuel effect pieces containing Refractory Ceramic Fibres (R.C.F.), which are man-made vitreous silicate fibres. Excessive exposure to these materials may cause temporary irritation to eyes, skin and respiratory tract. Consequently, it makes sense to take care when handling these articles to ensure that the release of dust is kept to a minimum. To ensure that the release of fibres from these R.C.F. articles is kept to a minimum, during installation & servicing we recommend that you use a HEPA filtered vacuum to remove any dust and soot accumulated in and around the fire, before and after working on the fire. When replacing these articles we recommend that the replaced items are not broken up, but are sealed within a heavy duty polythene bag, clearly labelled as “RCF waste”. This is not classified as “hazardous waste” and may be disposed of at a tipping site licensed for the disposal of industrial waste. Protective clothing is not required when handling these articles, but we do recommend you follow the normal hygiene rules of not smoking, eating or drinking in the work area, and always wash your hands before eating or drinking.

This appliance does not contain any component manufactured from asbestos or asbestos related products.

Refit the glass frame as detailed in section 2.8, then light the appliance as detailed in section 3.4 / 3.5 as applicable.

3.2 MAKING THE GAS CONNECTION & CHECKING FOR GAS TIGHTNESS

- 3.2.1 Before making the final gas connection, thoroughly purge the gas supply pipework to remove all foreign matter, otherwise serious damage may be caused to the gas control valve on the fire. Failure to purge the gas supply will invalidate the guarantee.
- 3.2.2 The gas connection should be made to the appliance inlet elbow to using 8mm rigid tubing.
- 3.2.3 Remove the pressure test point screw from the inlet elbow and fit a manometer.
- 3.2.4 Turn on the main gas supply and carry out a gas tightness test.

3.3 REMOVAL & RE-FITTING OF THE TRIM ASSEMBLY

3.3.1 The trim is attached to firebox by 4 off magnets as shown below in figure 22.

Fig. 22

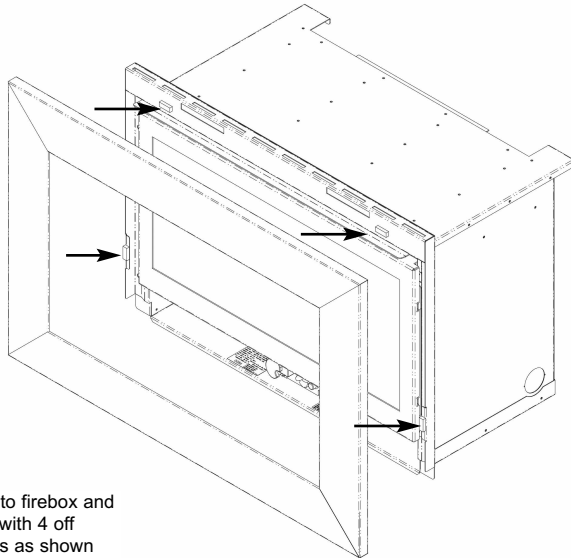

3.3.2 Ensure the trim is securely fitted to the fire.

3.4 LIGHTING THE APPLIANCE

Before attempting to light the appliance, please determine which remote control system the product is fitted with. To determine this, check the handset designs as shown below and follow the instructions on the proceeding pages as necessary.

3.4.1 If fitted with the S.I.T. ACS2T System, the handset as shown below in figure 25 will have been supplied. Please refer to section 3.4.3 to section 3.4.7.

Fig. 23



3.4.2 If fitted with the Mertik Maxitrol GV60 system, the handset as shown below in figure 26 will have been supplied. Please refer to section 3.5.1 to section 3.5.6

Fig. 24



3.4.3 LIGHTING THE APPLIANCE - S.I.T. ACS2T REMOTE CONTROL

IMPORTANT : IF THE BURNER IS EXTINGUISHED FOR ANY REASON YOU MUST ENSURE THAT YOU WAIT A FULL FIVE MINUTES BEFORE ATTEMPTING TO RE-LIGHT THE FIRE.

The product is controlled by the remote handset supplied with the fire. Ensure the 3 off AAA batteries supplied in the loose items pack has been fitted to the handset and the 6 off AA batteries have been fitted to the battery holder located in the front of the fire before attempting to light it. There are 3 modes of operation of the product, "MANUAL mode", "TEMPERATURE mode" and "TIMER mode".

3.4.4 Operation of the Fire in "MANUAL" mode

- a) Firstly turn the handset on and light the fire by pressing and holding the "ON" / "OFF" button on the remote handset for a minimum of 2 seconds as shown below in figure 25, then releasing the button. The screen will illuminate and the "MAN" mode will be illuminated as shown below in figure 25. The 20 second ignition procedure is then initiated, the pilot and main burner will light.

Fig. 25

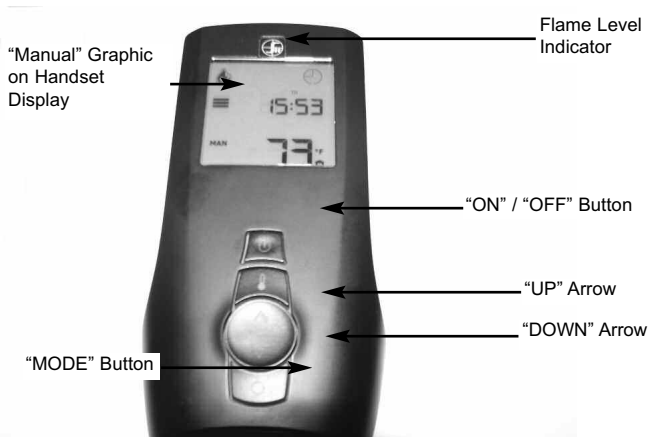

- b) The remote handset is now used to control all functions of the fire. To turn the fire down or up incrementally, press the "DOWN" / "UP" arrows as shown above in figure 25 and the gas input will reduce accordingly. The flame level indicator will increase and decrease with the input. When maximum input is reached, a "MAX" icon will appear below the flame indicator in the top left hand corner. To put the fire into "STANDBY" mode (where only the pilot remains lit) press the "ON" / "OFF" button, the "PILOT" indicator will be shown and the main burner will extinguish. See figure 26 overpage.

Fig. 26



- c) To turn the fire off, press and hold the “ON” / “OFF” button, this will extinguish all flames including the pilot.
- d) **If is recommended that the handset is placed into locked mode when not in use. To lock the handset, press and hold the “MODE” button for a minimum of 5 seconds. To unlock the handset, press and hold the “MODE” button for a minimum of 5 seconds.**

3.4.5 Operation of the Fire in “AUTOMATIC” mode

- a) Firstly turn the handset on and light the fire by pressing and holding the “ON” / “OFF” button on the remote handset for a minimum of 2 seconds as shown in figure 25, section 3.4.4 a).
- b) Press the “THERMOSTATIC” button on the handset below as shown in figure 27, the handset will then switch to “AUTOMATIC” mode and the “AUTO” icon will appear on the display as shown.

Fig. 27

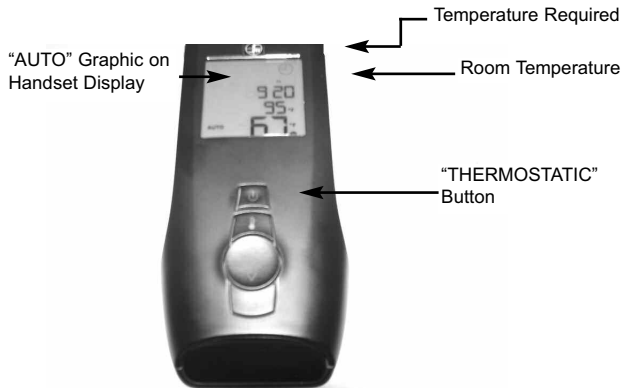

- c) The large digit temperature display shows the room temperature that the handset is sensing at the time. The small digit temperature display shows the temperature that you wish to achieve in the room. See figure 27 above. To adjust, press the “UP” / “DOWN” arrow keys on the handset. When “AUTO” mode is selected, the remote handset, by means of an internal thermostat in the handset checks the difference in temperature between the temperature you require and the room ambient at a fixed time interval. Depending on the difference, the flame level is modulated to maintain the required temperature. Once the requested temperature is reached, the flame level is reduced to the minimum level and remains in this state for a 2 minutes period, then it will switch to standby mode (pilot only lit) and the “PILOT” icon will appear on the display. As soon as the room temperature falls below the set room temperature, the main burner will light and the fire will modulate between the high and low settings.

3.4.6 Operation of the Fire in “PROGRAMME FUNCTION” mode

- a) The handset is pre-programmed with ten off alternative settings to give various options of timed, automatic usage. Please see table below for the details of these 10 pre-set functions.

Programme Number	Time ON (Monday to Friday)	Time OFF (Monday to Friday)	Time ON (Saturday / Sunday)	Time OFF (Saturday / Sunday)
1	06:00	23:00	07:00	12:00
2	06:00 - 09:00 & 17:00 - 23:00	09:00 - 17:00 & 23:00 - 06:00	07:00	00:00
3	06:00 - 09:00, 12:00 - 15:00 & 17:00 - 23:00	09:00 - 12:00, 15:00 - 17:00 & 23:00 - 06:00	07:00	00:00
4	04:00 - 08:00, 11:00 - 14:00 & 17:00 - 22:00	08:00 - 11:00, 14:00 - 17:00 & 22:00 - 04:00	06:00	23:00
5	05:00 - 08:00, 12:00 - 14:00 & 17:00 - 23:00	08:00 - 12:00, 14:00 - 17:00 & 23:00 - 05:00	05:00 - 11:00 & 16:00 - 00:00	11:00 - 16:00 & 00:00 - 05:00
6	05:00 - 07:00 & 13:00 - 23:00	07:00 - 13:00 & 23:00 - 05:00	08:00 - 00:00	00:00 - 07:00
7	07:00 - 10:00, 13:00 - 15:00 & 18:00 - 23:00	10:00 - 13:00, 15:00 - 18:00 & 23:00 - 07:00	07:00 - 23:00	07:00 - 23:00
8	07:00 - 10:00 & 18:00 - 23:00	10:00 - 18:00 & 23:00 - 07:00	07:00 - 23:00	07:00 - 23:00
9	08:00 - 12:00 & 15:00 - 19:00	15:00 - 19:00	Off All Day	Off All Day
10	18:00 - 00:00	00:00 - 18:00	07:00 - 23:00	23:00 - 06:00

- b) To set the handset in “PROGRAMME FUNCTION” mode, please press the “MODE” key as shown below in figure 28. This will then illuminate the display and by using the “UP” and “DOWN” arrows on the handset you can then toggle between the programs 1 to 10 or the “OFF” position to disable the programmeable function.

Fig. 28



3.4.7 Low Battery Signal

- 3.4.7.1 When the batteries in the handset needs replacing, a small battery symbol will appear on the handset.
- 3.4.7.2 Remove the cover on the rear of the handset and replace the 3 off AAA batteries as necessary.

3.4.8 To Set the Time on the Remote Handset

- 3.4.8.1 Simultanelously press the "O" and "THERMOSTATIC" buttons on the remote handset. The "CLOCK" icon will appear on the screen. To set the hour use the "UP" and "DOWN" arrows.
- 3.4.8.2 Press the "O" button on the handset to switch to the minute setting and To set the minute use the "UP" and "DOWN" arrows. When the time is correctly set, either use the "O" button to exit or leave for 5 seconds and the handset will automatically exit the "CLOCK" mode.

3.4.9 To Set °C or °F on the Handset Display

- a) Press and hold the "THERMOSTATIC" button for a period of 5 seconds and the display will change from °C to °F and vice versa.

3.5 LIGHTING THE APPLIANCE - MERTIK MAXITROL GV60 REMOTE CONTROL

IMPORTANT : IF THE BURNER IS EXTINGUISHED FOR ANY REASON YOU MUST ENSURE THAT YOU WAIT A FULL FIVE MINUTES BEFORE ATTEMPTING TO RE-LIGHT THE FIRE.

The product is controlled by the remote handset supplied with the fire. Ensure the 9V battery as supplied in the loose items pack has been fitted to the fire before attempting to light it and the 4 off AA batteries have been fitted to the reciever unit, located next to the control valve at the L/H/S. There are 3 modes of operation of the product, "MANUAL mode", "TEMPERATURE mode" and "TIMER mode".

3.5.1 Operation of the Fire in "MANUAL" mode

- a) Locate the ON/OFF switch on the appliance, it is situated behind the controls access cover at the bottom of the fire. Ensure that the on / off switch on the valve is in the "ON" (1) position as shown below in figure 29

Fig. 29

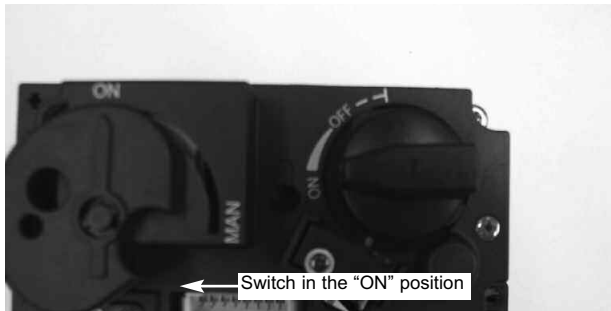

- b) The remote handset is now used to control all functions of the fire. To light the fire, press the "UP" arrow and "OFF" button simultaneously, as shown on figure 32 below. You will hear a click and the fire begins a 30 second ignition process. The pilot and main burner will light. The appliance is now in "MANUAL mode" which will be shown via the "MAN" graphic on the display of the handset as shown below in figure 30.

Fig. 30

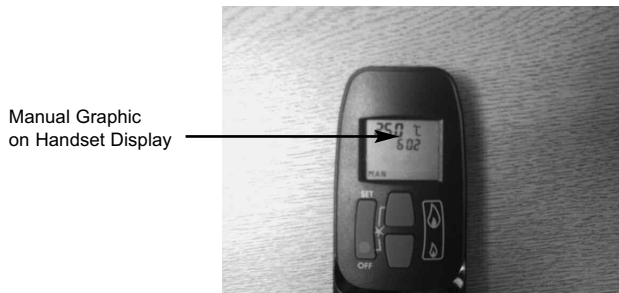

- c) With the product in “MANUAL” mode the fire can now be switched between HIGH rate heat input and LOW rate heat input by pressing the “DOWN” arrow on the handset. To reduce the flame height of the main burner incrementally, press the arrow momentarily. To reduce the heat input directly down to the minimum level, press the “SMALL” flame arrow on the handset twice, “LO” will be displayed. NOTE : The flame will go to HIGH rate heat input before going to designated LOW rate heat input. To return back to HIGH rate heat input press the “LARGE” flame button twice. To put the fire in In “STANDBY MODE” (only the pilot remains lit) press and hold the “SMALL” flame arrow on the handset. See figure 31 below.

Fig. 31

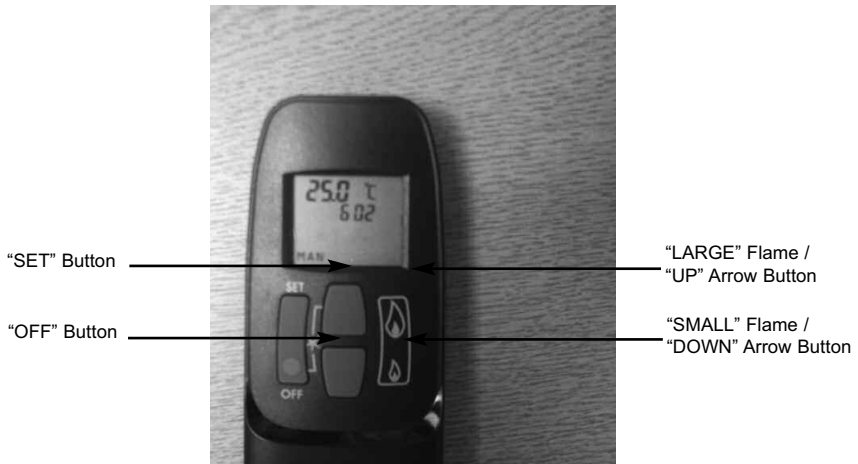

- d) To turn the fire off, press the “OFF” button, this will extinguish all flames including the pilot.

3.5.2 Operation of the Fire in “TEMPERATURE” mode

- a) In order to change the mode of operation from “MANUAL” to “TEMPERATURE”, press the “SET” button, the fire will then change to either “DAY TEMP” (figure 32) mode or “NIGHT TEMP” mode (figure 33). To alternate between the 2, press the “SET” button. **The display on the handset will show the current temperature in the room.**

Fig. 32



Fig. 33

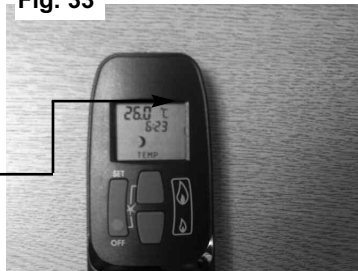

“DAY TEMP”
Mode

“NIGHT TEMP”
Mode

NOTE : The “SET” button allows you to alternate between all modes of operation :- “MANUAL”, “DAY TEMP”, “NIGHT TEMP”, “TIMER” and back to “MANUAL”. Alternatively, pressing either the “UP” or “DOWN” arrow allows the unit to revert to “MANUAL” mode. **Fire must be in standby mode (pilot must be lit) for temperature mode to be used.**

- b) Within the “TEMPERATURE” mode there are options for either “DAY TEMP” or “NIGHT TEMP”. These temperatures can be set independently to allow a higher temperature to be maintained at night than during the day, or if setting the same temperature for day and night the fire will compensate for the generally cooler evening temperatures and automatically increase the heat input level accordingly.
- c) To set the temperature, ensure the handset is in “TEMPERATURE” mode and then press the “SET” button until the “TEMP” display flashes then let go. Proceed to set the desired temperature by pressing the “UP” (large flame) or “DOWN” (small flame) arrows as necessary, then press “OFF” to complete the process.
NOTE : Minimum temperature is 5°C, Maximum temperature is 30°C, or minimum 41F to maximum 86F when in Fahrenheit mode.
- d) Press the “OFF” button to stop the display flashing or wait to return to “TEMPERATURE” mode. **NOTE :** If you set a temperature below the current room temperature the fire will switch to standby mode (pilot burner only) until the room has cooled to the temperature you have set on the handset display.
- e) If you would like the “NIGHT TEMP” to turn the fire off then decrease the temperature until [----] is displayed.

3.5.3 Operation of the Fire in “TIMER” mode

- a) In order to change the mode of operation from “MANUAL” to “TIMER”, press the “SET” button, the fire will then alternate between the settings until the “TIMER” mode is displayed.

NOTE : The “SET” button allows you to alternate between all modes of operation :- “MANUAL”, “DAY TEMP”, “NIGHT TEMP”, “TIMER” and back to “MANUAL”. Alternatively, pressing either the “UP” or “DOWN” arrow allows the unit to revert to “MANUAL” mode. **Fire must be in standby mode (pilot must be lit) for temperature mode to be used.**

- b) Within the “TIMER” setting mode there are two programmable settings you can make over a 24 hour period, namely P1 and P2. To set the timer, ensure the handset is in “TIMER” mode as detailed in section a) above.
- c) To set the P1 timed start setting, press and hold the “SET” button until the P1 (sun symbol is displayed as per figure 34 below) and the time flashes. Set the hour by pressing the “UP” (large flame) and set the minutes (in ten minute increments) by pressing the “DOWN” (small flame) as necessary, then press “OFF” button to complete the process. Repeat for the P1 (moon symbol is displayed as per figure 35 below) Set the hour by pressing the “UP” (large flame) and set the minutes (in ten minute increments) by pressing the “DOWN” (small flame) as necessary, then press “OFF” button to complete the process.

P1 with “Sun” symbol illuminated

Fig. 34



P1 with “Moon” symbol illuminated

Fig. 35



- d) To set the P2 timed setting, press the “SET” button until the “TIMER” mode is displayed. Hold the “SET” button until the display flashes the current time for P1. Press the “SET” button again to scroll past the setting for P1 (sun) and P1 (moon). The time should now be flashing on the handset. Set the hour by pressing the “UP” (large flame) and set the minutes (in ten minute increments) by pressing the “DOWN” (small flame) as necessary, then press “OFF” button to complete the process.

3.5.4 Low Battery Signal

- a) When the battery in the handset needs replacing, "BATT" will be displayed on the handset.
- b) Remove the cover on the rear of the handset and replace the 9V battery as necessary.

3.5.5 To Set the Time on the Remote Handset

- a) Simultaneously press the "UP" (large flame) arrow and "DOWN" (small flame) arrow buttons on the remote handset.
- b) Press the "UP" (large flame) arrow to set the hour and the "DOWN" (small flame) arrow to set the minutes.

3.5.6 To Set the °C / 24 Hour or °F / 12 Hour Clock

- a) Press and hold the "OFF" and the "DOWN" (small flame) arrow buttons on the handset simultaneously until the display changes from °C to °F and vice versa

3.7 CHECKING FOR CLEARANCE OF COMBUSTION PRODUCTS

- 3.7.1 Close all doors and windows in the room.
- 3.7.2 Light the fire and allow to run for approximately 5 minutes on high position.
- 3.7.3 After approximately 5 minutes hold a smoke match just inside and below the centre of the lower front edge of the top of the fire as shown in figure 36 below (It is recommended that a suitable smoke match holder is used when checking for clearance of combustion products). All smoke generated should be drawn back into the flue. If slight spillage occurs or if in doubt, repeat the test after a further 5-10 minutes.
- 3.7.4 If spillage persists, the flue is not functioning correctly and a fault exists. If, after investigation the fault cannot be traced and rectified, the fire must be disconnected from the gas supply and expert advice obtained.
- 3.7.5 If there is an extractor fan fitted anywhere in the vicinity of the appliance, the spillage test should be repeated with the fan running on maximum and all interconnecting doors open.
- 3.7.6 After ensuring that the fire is safe to use it should be left on high position to fully warm up. During this time a slight odour may be noticed, this is due to the "newness" of the fire and will soon disappear.

Fig. 36



Smoke match position
10mm inside and down
from top face of central
slot

SECTION 4 MAINTENANCE

Servicing Notes

Servicing should be carried out annually by a competent person such as a GAS SAFE registered engineer. It is a condition of Flavel Fires guarantee schemes that this is carried out by a competent person i.e a GAS SAFE registered Engineer in accordance with these servicing notes, and as a condition of the guarantee the oxypilot must be changed.

The condition of the logs should be checked and if necessary the whole set should be replaced with a genuine replacement set. The product must be removed from the opening to check for debris accumulation if fitted without a flue liner. See label attached to gas inlet elbow to see if appliance was fitted without a flue liner when originally installed. After any servicing work a gas tightness check must always be carried out.

4.1 Removing the burner assembly from the fire.

- 4.1.1 Isolate the gas supply.
- 4.1.2 Remove trim from the front of the fire, as shown in section 3.3
- 4.1.3 Remove the glass frame assembly from the fire, as shown in section 2.7
- 4.1.4 Remove the log set and loose gravel from the combustion chamber base, taking care not to damage the logs.
- 4.1.5 Remove the access panel from the combustion chamber, which is secured using six screws.
- 4.1.6 Remove the two burner retaining screws, 1 at each end of the burner.
- 4.1.7 Slide the burner off the main injector and remove from the product.

4.2 Removing the control valve sub assembly from the fire.

- 4.2.1 Isolate the gas supply.
- 4.2.1 Remove trim from the front of the fire, as shown in section 3.4
- 4.2.2 Disconnect the pipe to the bulkhead fitting on the valve and disconnect the pipe on the valve which runs to the inlet elbow.
- 4.2.3 Loosen the pilot pipe, disconnect the ignition lead from the electrode and disconnect the thermocouple from the pilot assembly.

4.2.5 Remove the 2 off fixing screws which hold the valve to its mounting bracket and lift the valve and its mounting plate away from the combustion chamber.

4.2.6 Swap the valve (and receiver / control board on the SIT equipped models) mounting plate onto the new valve and replace the fixings holding it in position.

4.2.7 Re-assemble with pipes etc. in reverse order.

4.3 Removing the RF receiver (SIT ACS 2 T equipped models only)

4.3.1 Remove the control valve sub assembly as described in section 4.2

4.3.3 Disconnect the receiver unit from the control board and re-fit the new receiver in its place.

4.4 Removing the Pilot Assembly

4.4.1 Isolate the gas supply

4.4.2 Remove trim from the front of the fire, as shown in section 3.3

4.4.3 Remove the glass frame assembly from the fire, as shown in section 2.7

4.4.4 Loosen the pilot pipe and disconnect the ignition lead from the electrode.

4.4.5 Remove the two fixing screws which secure the pilot assembly to the burner unit.

4.4.6 Remove the pilot assembly.

4.4.7 Re-assemble with a new pilot assembly, and carry out a gas tightness test after re-assembly.

4.5 Replacing the Control Board (SIT ACS 2 T equipped models only)

4.5.1 Remove the control valve sub assembly as described in section 4.2

4.5.2 Disconnect all wiring looms from the control board.

4.5.3 Remove the 4 off screws which hold the control board to the mounting plate.

4.6 Replacing the Batteries in the Handset

- 4.6.1 Remove and re-fit the new 9V battery by removing the cover on the back of the handset on the Mertik Maxitrol handset or 3 off AAA batteries on the SIT unit.

Parts Shortlist

SIT Control Valve	B-106790	ODS Pilot (Mertik)	B-38930
SIT Handset	B-129150	ODS Pilot (SIT)	B-49710
SIT Receiver Unit	B-129160	Glass Panel	B-100310
SIT Control Board	B-129140	Mertik Gas Valve	B-92200
		Receiver unit	B-153140
		Thermostatic handset	B-148120

Complete Ceramic Set inc. 5 logs & bag of loose gravel (All Models)	B-105650
Loose Gravel Set (All Models)	B-105660
Base Log "A" (All Models)	B-105670
Log "B" (All Models)	B-105680
Log "C" (All Models)	B-105690
Log "D" (All Models)	B-105700
Log "E" (All Models)	B-105710

SECTION FIVE - USER INSTRUCTIONS

5.1 INSTALLATION INFORMATION

CONDITIONS OF INSTALLATION

It is the law that all gas appliances are installed only by a competent (e.g. GAS SAFE Registered) Installer, in accordance with the installation instructions and the Gas Safety (Installation and Use) Regulations 1998 as amended. Failure to install appliances correctly could lead to prosecution. It is in your own interest and that of safety to comply with the law.

The fire may be fitted below a combustible shelf provided that the shelf is at least 300mm above the top of the appliance and the depth of the shelf does not exceed 150mm.

The fire may be installed below combustible shelves, which exceed 150mm deep providing that the clearance above the fire is increased by 15mm for each 25mm of additional overhang in excess of 150mm.

If this appliance is fitted directly on to a wall without the use of a fireplace or surround, soft wall coverings such as wallpaper, blown vinyl etc. could be affected by the heat and may discolour or scorch. This should be considered when installing or decorating.

The Model number of this appliance is FHCL**RN and it is manufactured by :-

** denotes trim and colour variant

BFM Europe Ltd.
Trentham Lakes
Stoke-on-Trent
Staffordshire
ST4 4TJ

5.2 ABOUT YOUR NEW JAZZ HE ROOM HEATER

The Flavel Jazz High Efficiency log effect room heater incorporates a unique and highly developed fuel bed which gives the realism of a loose log layout combined with realistic flames and glow. The use of durable hard ceramic material in the construction of the fuelbed components ensures long and trouble free operation. When first using the new fire a slight smell may be noticed. This is due to small deposits of oil on the firebox, but will soon disappear. Please take the time to fully read these instructions as you will then be able to obtain the most effective and safe operation of your fire.

DO NOT UNDER ANY CIRCUMSTANCES ATTEMPT TO USE THIS APPLIANCE IF THE GLASS PANEL IS BROKEN OR HAS BEEN REMOVED.

IMPORTANT SAFETY INFORMATION

WARNING : This appliance has a hot surface and as with all heating appliances a fireguard should be used for the protection of children, the elderly and infirm. Fireguards should conform to B.S. 8423 : 2002 (Fireguards for use with gas heating appliances). Servicing should be carried out annually by a competent person such as a GAS SAFE registered engineer. It is a condition of BFM Europe Ltd. lifetime guarantees schemes that this is carried out by a competent person i.e a GAS SAFE registered Engineer.

The service should include visually checking the appliance, flue terminal and fireplace for accumulation of debris around the firebox, and inspection of the ceramic logs, replacing as necessary. Should debris be found upon the fuel-bed, please contact a GAS SAFE registered installer. The condition of the ceramic log set should be carefully checked and **if necessary the whole unit should be replaced with a genuine replacement set.**

After any servicing work a gas tightness check must always be carried out. Any debris or deposits should be removed from the log set from time to time. This may be carried out by referring to the cleaning section as described later in this book. Only the fuelbed components as supplied must be used and complete and genuine replacements must be used. Always keep furniture and combustible materials well clear of the fire and never dry clothing or items either on or near to the fire. Never use aerosols or flammable cleaning products near to the fire when it is in use.

5.3 SPILLAGE MONITORING SYSTEM

This appliance is fitted with a spillage monitoring system which shuts down the fire if the evacuation of combustion products from the fire is affected by a partially or fully blocked flue pipe. If this system operates the fire will go out. If this occurs, leave the fire for at least three minutes then follow the lighting procedure as described in the previous section.

In the event of repeated operation a GAS SAFE registered gas installer must be called to investigate and rectify the cause.

The fuel bed remains hot for a considerable period after use and sufficient time should be allowed for the fire to cool before cleaning etc.

The fire must only be operated with the trim as supplied, in position.

5.4 LIGHTING THE APPLIANCE

Before attempting to light the appliance, please determine which remote control system the product is fitted with. To determine this, check the handset designs as shown below and follow the instructions on the proceeding pages as necessary.

- 5.4.1** If fitted with the S.I.T. ACS2T System, the handset as shown below in figure 1 will have been supplied. Please refer to section 5.4.3 to section 5.4.9

Fig. 1



- 5.4.2** If fitted with the Mertik Maxitrol GV60 system, the handset as shown below in figure 2 will have been supplied. Please refer to section 5.5.1 to section 5.5.6

Fig. 2



5.4.3 LIGHTING THE APPLIANCE - S.I.T. ACS2T REMOTE CONTROL

IMPORTANT : IF THE BURNER IS EXTINGUISHED FOR ANY REASON YOU MUST ENSURE THAT YOU WAIT A FULL FIVE MINUTES BEFORE ATTEMPTING TO RE-LIGHT THE FIRE.

The product is controlled by the remote handset supplied with the fire. Ensure the 3 off AAA batteries supplied in the loose items pack has been fitted to the handset and the 6 off AA batteries have been fitted to the battery holder located in the front of the fire before attempting to light it. There are 3 modes of operation of the product, "MANUAL mode", "TEMPERATURE mode" and "TIMER mode".

5.4.4 Operation of the Fire in "MANUAL" mode

- a) Firstly turn the handset on and light the fire by pressing and holding the "ON" / "OFF" button on the remote handset for a minimum of 2 seconds as shown below in figure 3, then releasing the button. The screen will illuminate and the "MAN" mode will be illuminated as shown below in figure 3. The 20 second ignition procedure is then initiated, the pilot and main burner will light.

Fig. 3

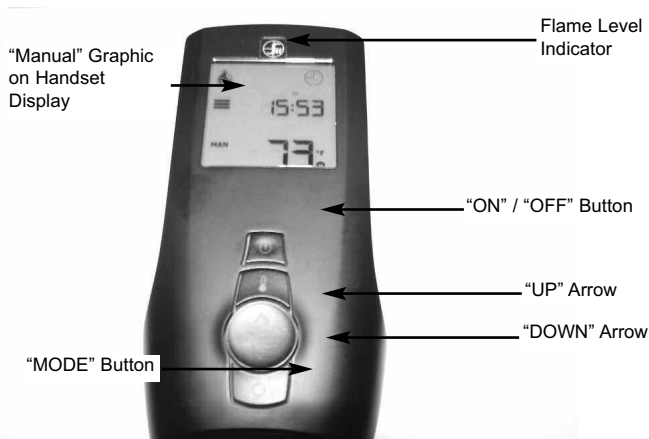

- b) The remote handset is now used to control all functions of the fire. To turn the fire down or up incrementally, press the "DOWN" / "UP" arrows as shown above in figure 3 and the gas input will reduce accordingly. The flame level indicator will increase and decrease with the input. When maximum input is reached, a "MAX" icon will appear below the flame indicator in the top left hand corner. To put the fire into "STANDBY" mode (where only the pilot remains lit) press the "ON" / "OFF" button, the "PILOT" indicator will be shown and the main burner will extinguish. See figure 4 overpage.

Fig. 4

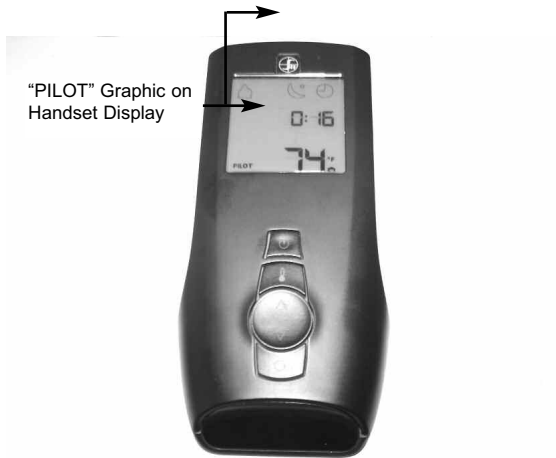

- c) To turn the fire off, press and hold the “ON” / “OFF” button for a minimum of 2 seconds (then release the “ON” / “OFF” button), this will extinguish all flames including the pilot.
- d) **If is recommended that the handset is placed into locked mode when not in use. To lock the handset, press and hold the “MODE” button for a minimum of 5 seconds. To unlock the handset, press and hold the “MODE” button for a minimum of 5 seconds.**

5.4.5 Operation of the Fire in “AUTOMATIC” mode

- a) Firstly turn the handset on and light the fire by pressing and holding the “ON” / “OFF” button on the remote handset for a minimum of 2 seconds as shown in figure 3, section 5.4.4
- b) Press the “THERMOSTATIC” button on the handset below as shown in figure 5, the handset will then switch to “AUTOMATIC” mode and the “AUTO” icon will appear on the display as shown.

Fig. 5

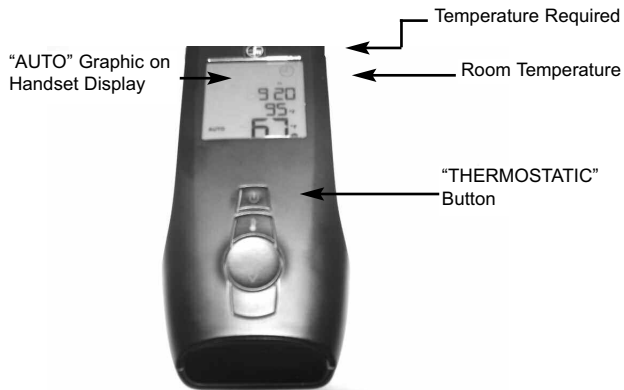

- c) The large digit temperature display shows the room temperature that the handset is sensing at the time. The small digit temperature display shows the temperature that you wish to achieve in the room. See figure 5 above. To adjust, press the “UP” / “DOWN” arrow keys on the handset. When “AUTO” mode is selected, the remote handset, by means of an internal thermostat in the handset checks the difference in temperature between the temperature you require and the room ambient at a fixed time interval. Depending on the difference, the flame level is modulated to maintain the required temperature. Once the requested temperature is reached, the flame level is reduced to the minimum level and remains in this state for a 2 minutes period, then it will switch to standby mode (pilot only lit) and the “PILOT” icon will appear on the display. As soon as the room temperature falls below the set room temperature, the main burner will light and the fire will modulate between the high and low settings.

5.4.6 Operation of the Fire in “PROGRAMME FUNCTION” mode

- a) The handset is pre-programmed with ten off alternative settings to give various options of timed, automatic usage. Please see table below for the details of these 10 pre-set functions.

Programme Number	Time ON (Monday to Friday)	Time OFF (Monday to Friday)	Time ON (Saturday / Sunday)	Time OFF (Saturday / Sunday)
1	06:00	23:00	07:00	12:00
2	06:00 - 09:00 & 17:00 - 23:00	09:00 - 17:00 & 23:00 - 06:00	07:00	00:00
3	06:00 - 09:00, 12:00 - 15:00 & 17:00 - 23:00	09:00 - 12:00, 15:00 - 17:00 & 23:00 - 06:00	07:00	00:00
4	04:00 - 08:00, 11:00 - 14:00 & 17:00 - 22:00	08:00 - 11:00, 14:00 - 17:00 & 22:00 - 04:00	06:00	23:00
5	05:00 - 08:00, 12:00 - 14:00 & 17:00 - 23:00	08:00 - 12:00, 14:00 - 17:00 & 23:00 - 05:00	05:00 - 11:00 & 16:00 - 00:00	11:00 - 16:00 & 00:00 - 05:00
6	05:00 - 07:00 & 13:00 - 23:00	07:00 - 13:00 & 23:00 - 05:00	08:00 - 00:00	00:00 - 07:00
7	07:00 - 10:00, 13:00 - 15:00 & 18:00 - 23:00	10:00 - 13:00, 15:00 - 18:00 & 23:00 - 07:00	07:00 - 23:00	07:00 - 23:00
8	07:00 - 10:00 & 18:00 - 23:00	10:00 - 18:00 & 23:00 - 07:00	07:00 - 23:00	07:00 - 23:00
9	08:00 - 12:00 & 15:00 - 19:00	15:00 - 19:00	Off All Day	Off All Day
10	18:00 - 00:00	00:00 - 18:00	07:00 - 23:00	23:00 - 06:00

- b) To set the handset in “PROGRAMME FUNCTION” mode, please press the “MODE” key as shown below in figure 6. This will then illuminate the display and by using the “UP” and “DOWN” arrows on the handset you can then toggle between the programs 1 to 10 or the “OFF” position to disable the programmeable function.

Fig. 6



5.4.7 Low Battery Signal

- a) When the batteries in the handset needs replacing, a small battery symbol will appear on the handset.
- b) Remove the cover on the rear of the handset and replace the 3 off AAA batteries as necessary.

5.4.8 To Set the Time on the Remote Handset

- a) Simultanelously press the “O” and “THERMOSTATIC” buttons on the remote handset. The “CLOCK” icon will appear on the screen. To set the hour use the “UP” and “DOWN” arrows.
- b) Press the “O” button on the handset to switch to the minute setting and To set the minute use the “UP” and “DOWN” arrows. When the time is correctly set, either use the “O” button to exit or leave for 5 seconds and the handset will automatically exit the “CLOCK” mode.

5.4.9 To Set °C or °F on the Handset Display

- a) Press and hold the “THERMOSTATIC” button for a period of 5 seconds and the display will change from °C to °F and vice versa.

5.4.10 Turning the Product Off in the Unlikely event of a Remote Handset Malfunction.

- a) In the unlikely event of the remote control handset malfunctioning (or if lost or broken) after the appliance has been turned on, the fire can be turned off via the emergency shut off switch on the control panel.
- b) To turn the product off, firstly remove the trim from the fire.
- c) Press and hold the emergency shut off switch for up to sixty seconds.
- d) When you release the emergency shut off switch, the fire will shutdown.
- e) The appliance will now remain in the “off” position until activated by the remote handset.

5.5 LIGHTING THE APPLIANCE - MERTIK MAXITROL GV60 REMOTE CONTROL

IMPORTANT : IF THE BURNER IS EXTINGUISHED FOR ANY REASON YOU MUST ENSURE THAT YOU WAIT A FULL FIVE MINUTES BEFORE ATTEMPTING TO RE-LIGHT THE FIRE.

The product is controlled by the remote handset supplied with the fire. Ensure the 9V battery as supplied in the loose items pack has been fitted to the fire before attempting to light it and the 4 off AA batteries have been fitted to the reciever unit, located next to the control valve at the L/H/S. There are 3 modes of operation of the product, "MANUAL mode", "TEMPERATURE mode" and "TIMER mode".

5.5.1 Operation of the Fire in "MANUAL" mode

- a) Locate the ON/OFF switch on the appliance, it is situated behind the controls access cover at the bottom of the fire. Ensure that the on / off switch on the valve is in the "ON" (1) position as shown below in figure 7

Fig. 7

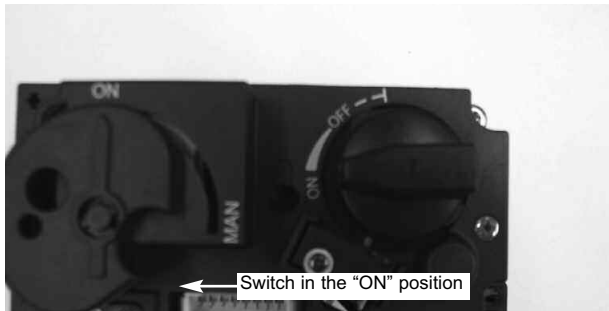

- b) The remote handset is now used to control all functions of the fire. To light the fire, press the "UP" arrow and "OFF" button simultaneously, as shown on figure 8 below. You will hear a click and the fire begins a 30 second ignition process. The pilot and main burner will light. The appliance is now in "MANUAL mode" which will be shown via the "MAN" graphic on the display of the handset as shown below in figure 8.

Fig. 8

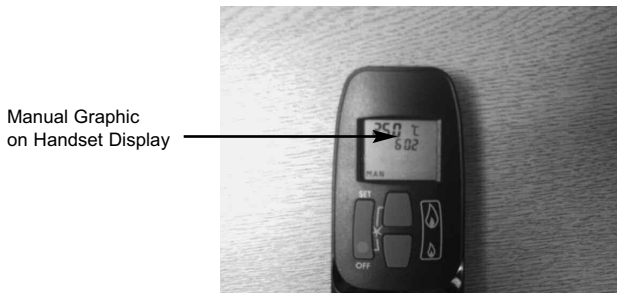

- c) With the product in “MANUAL” mode the fire can now be switched between HIGH rate heat input and LOW rate heat input by pressing the “DOWN” arrow on the handset. To reduce the flame height of the main burner incrementally, press the arrow momentarily. To reduce the heat input directly down to the minimum level, press the “SMALL” flame arrow on the handset twice, “LO” will be displayed. NOTE : The flame will go to HIGH rate heat input before going to designated LOW rate heat input. To return back to HIGH rate heat input press the “LARGE” flame button twice. To put the fire in In “STANDBY MODE” (only the pilot remains lit) press and hold the “SMALL” flame arrow on the handset. See figure 9 below.

Fig. 9

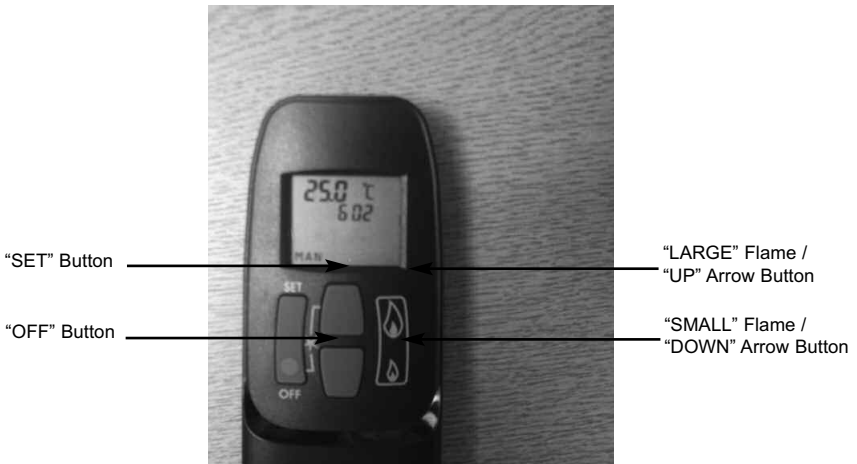

- d) To turn the fire off, press the “OFF” button, this will extinguish all flames including the pilot.

5.5.2 Operation of the Fire in “TEMPERATURE” mode

- a) In order to change the mode of operation from “MANUAL” to “TEMPERATURE”, press the “SET” button, the fire will then change to either “DAY TEMP” (figure 10) mode or “NIGHT TEMP” mode (figure 11). To alternate between the 2, press the “SET” button. **The display on the handset will show the current temperature in the room.**

Fig. 10

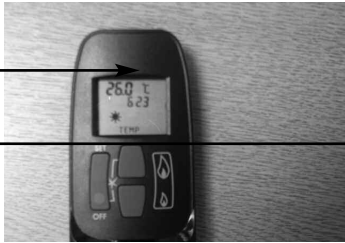
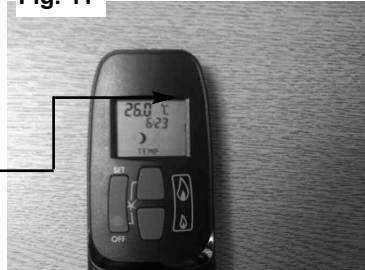

Fig. 11



“DAY TEMP”
Mode

“NIGHT TEMP”
Mode

NOTE : The “SET” button allows you to alternate between all modes of operation :- “MANUAL”, “DAY TEMP”, “NIGHT TEMP”, “TIMER” and back to “MANUAL”. Alternatively, pressing either the “UP” or “DOWN” arrow allows the unit to revert to “MANUAL” mode. **Fire must be in standby mode (pilot must be lit) for temperature mode to be used.**

- b) Within the “TEMPERATURE” mode there are options for either “DAY TEMP” or “NIGHT TEMP”. These temperatures can be set independently to allow a higher temperature to be maintained at night than during the day, or if setting the same temperature for day and night the fire will compensate for the generally cooler evening temperatures and automatically increase the heat input level accordingly.
- c) To set the temperature, ensure the handset is in “TEMPERATURE” mode and then press the “SET” button until the “TEMP” display flashes then let go. Proceed to set the desired temperature by pressing the “UP” (large flame) or “DOWN” (small flame) arrows as necessary, then press “OFF” to complete the process.
NOTE : Minimum temperature is 5°C, Maximum temperature is 30°C, or minimum 41F to maximum 86F when in Fahrenheit mode.
- d) Press the “OFF” button to stop the display flashing or wait to return to “TEMPERATURE” mode. **NOTE :** If you set a temperature below the current room temperature the fire will switch to standby mode (pilot burner only) until the room has cooled to the temperature you have set on the handset display.
- e) If you would like the “NIGHT TEMP” to turn the fire off then decrease the temperature until [---] is displayed.

5.5.3 Operation of the Fire in “TIMER” mode

- a) In order to change the mode of operation from “MANUAL” to “TIMER”, press the “SET” button, the fire will then alternate between the settings until the “TIMER” mode is displayed.

NOTE : The “SET” button allows you to alternate between all modes of operation :- “MANUAL”, “DAY TEMP”, “NIGHT TEMP”, “TIMER” and back to “MANUAL”. Alternatively, pressing either the “UP” or “DOWN” arrow allows the unit to revert to “MANUAL” mode. **Fire must be in standby mode (pilot must be lit) for temperature mode to be used.**

- b) Within the “TIMER” setting mode there are two programmable settings you can make over a 24 hour period, namely P1 and P2. To set the timer, ensure the handset is in “TIMER” mode as detailed in section a) above.
- c) To set the P1 timed start setting, press and hold the “SET” button until the P1 (sun symbol is displayed as per figure 12 below) and the time flashes. Set the hour by pressing the “UP” (large flame) and set the minutes (in ten minute increments) by pressing the “DOWN” (small flame) as necessary, then press “OFF” button to complete the process. Repeat for the P1 (moon symbol is displayed as per figure 13 below) Set the hour by pressing the “UP” (large flame) and set the minutes (in ten minute increments) by pressing the “DOWN” (small flame) as necessary, then press “OFF” button to complete the process.

P1 with “Sun” symbol illuminated

Fig. 12



P1 with “Moon” symbol illuminated

Fig. 13



- d) To set the P2 timed setting, press the “SET” button until the “TIMER” mode is displayed. Hold the “SET” button until the display flashes the current time for P1. Press the “SET” button again to scroll past the setting for P1 (sun) and P1 (moon). The time should now be flashing on the handset. Set the hour by pressing the “UP” (large flame) and set the minutes (in ten minute increments) by pressing the “DOWN” (small flame) as necessary, then press “OFF” button to complete the process.

5.5.4 Low Battery Signal

- a) When the battery in the handset needs replacing, "BATT" will be displayed on the handset.
- b) Remove the cover on the rear of the handset and replace the 9V battery as necessary.

5.5.5 To Set the Time on the Remote Handset

- a) Simultaneously press the "UP" (large flame) arrow and "DOWN" (small flame) arrow buttons on the remote handset.
- b) Press the "UP" (large flame) arrow to set the hour and the "DOWN" (small flame) arrow to set the minutes.

5.5.6 To Set the °C / 24 Hour or °F / 12 Hour Clock

- a) Press and hold the "OFF" and the "DOWN" (small flame) arrow buttons on the handset simultaneously until the display changes from °C to °F and vice versa.

5.6 CLEANING

WARNING : Before attempting any cleaning operation ensure that the fire has been allowed to fully cool.

5.6.1 CLEANING THE TRIM AND PAINTED METAL PARTS

The extruded aluminium trim that is supplied for use with this product must be gently cleaned with a damp cloth only. **Abrasive cleaners, chemical cleaning agents or any type of polish must never be used as damage to the paint may result.**

5.6.2 CLEANING THE FUEL BED

We do not recommend cleaning the fuelbed other than at annual service intervals. If carbon or soot accumulates on the logs, this should be removed by carefully brushing the fuelbed using a soft brush. For instructions on how to remove the glass panel please see page 55. **The log set is made from a form of refractory ceramic fibre and should be handled carefully to avoid generating dust, as this may be harmful if inhaled. As with some fibrous materials, handling fibrous materials without gloves could cause skin irritation.**

The fuelbed should never be washed or exposed to any cleaning agents or water.

Any damaged parts must be replaced by contacting your dealer, whose details may be found on the BFM Europe website, address on the rear page. The log set must only be replaced with a genuine replacement and the fire must never be run with a different log set fitted.

The log set must be carefully reassembled as stated in pages 51-54.

5.6.3 CLEANING THE GLASS PANEL

To clean the glass panel, first ensure that the fire is cool, **please note that the glass panel will remain hot for a considerable period when the fire has been switched off.** Remove the glass frame assembly from the product as described on page 55. Use a clean damp cloth and ceramic glass cleaner to remove any stains or deposits from the glass panel. Do not use scouring pads as this may scratch the surface finish of the glass panel.

PLEASE NOTE :- The glass will require cleaning periodically. Condensation produced by the products of combustion will create marks on the inside face of the glass panel.

5.7 REMOVAL & RE-FITTING THE FUEL-BED LOGSET

- 5.7.1 The gravel material should be first layed around the base of the combustion chamber as shown below in figure 14, leaving the rear section as shown to allow the fitting of Log "A". Where the cut outs are located in the base section gravel material should be left clear of these aperatures until the log set is fully fitted.

Fig. 14



- 5.7.2 Place the largest Log "A" centrally onto the fuel-bed support behind the burner flame strip. Ensure that the fuel-bed Log "A" is located centrally in the firebox, and that the front edge is parallel with the rear face of the burner flame strip as shown below in figure 15.

Fig. 15

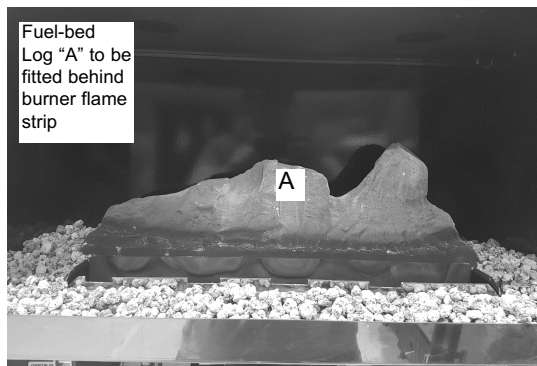

5.7.3 Fit Log “B” into position on right hand side of the fuel-bed base log “A” as shown below in figure 16, using the groove in Log “A” as a guide for placement, and locate the slot of the fork in the log into the cut-out of the base plate.

Fig. 16

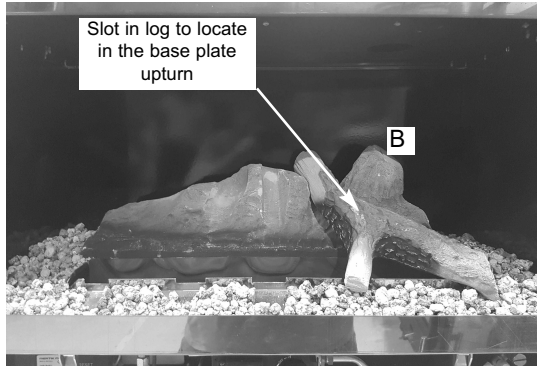

5.7.4 Fit Log “C” into position in the centre right side of the fuel-bed base log “A” as shown below in figure 17, using the groove in Log “A” as a guide for placement, and locate the slot in the log into the cut-out of the base plate.

Fig. 17

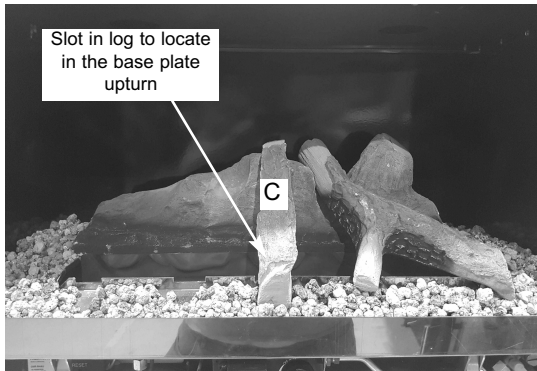

5.7.5 Fit Log “D” into position on centre left of the fuel-bed base log “A” as shown below in figure 18, using the groove in Log “A” as a guide for placement, and locate the log into the cut-out of the base plate.

Fig. 18

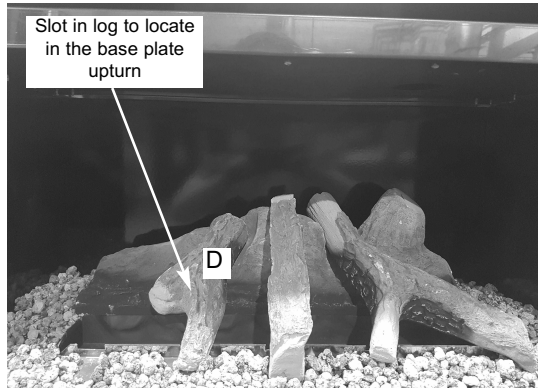

5.7.6 Fit Log “E” into position at left hand side of the fuel-bed base log “A” as shown below in figure 19, using the groove in the centre of Log “A” and locate the log slot into the cut-out in the base plate.

Fig. 19

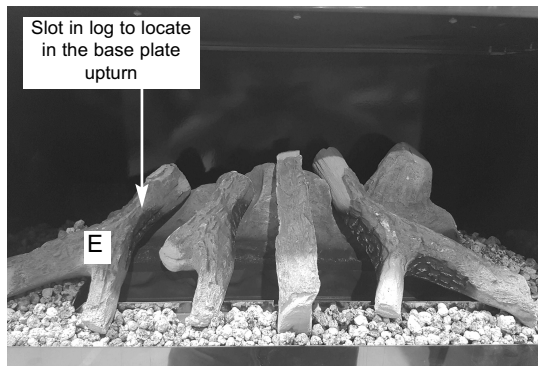

IMPORTANT NOTE

HAVING FITTED THE GRAVEL MATERIAL IN THE BASE OF THE COMBUSTION CHAMBER, ENSURE THAT NONE OF IT IS ON THE BURNER FLAME STRIP OR IN THE PILOT ASSEMBLY. IF MATERIAL IS OBSERVED VISUALLY ON THESE COMPONENTS, REMOVE THE FUEL-BED LOGSET, REMOVE THE GRAVEL MATERIAL FROM THE BURNER AND OR PILOT AND RE-FIT THE LOGS AS DETAILED IN SECTION 3.1 ABOVE.

Warning : Use only the logs supplied with the fire. When replacing the logs remove the old logs and discard them. Fit a complete set of logs of the correct type. Do not fit additional logs or any logs other than a genuine replacement set.

This appliance uses fuel effect pieces containing Refractory Ceramic Fibres (R.C.F.), which are man-made vitreous silicate fibres. Excessive exposure to these materials may cause temporary irritation to eyes, skin and respiratory tract. Consequently, it makes sense to take care when handling these articles to ensure that the release of dust is kept to a minimum. To ensure that the release of fibres from these R.C.F. articles is kept to a minimum, during installation & servicing we recommend that you use a HEPA filtered vacuum to remove any dust and soot accumulated in and around the fire, before and after working on the fire. When replacing these articles we recommend that the replaced items are not broken up, but are sealed within a heavy duty polythene bag, clearly labelled as “RCF waste”. This is not classified as “hazardous waste” and may be disposed of at a tipping site licensed for the disposal of industrial waste. Protective clothing is not required when handling these articles, but we do recommend you follow the normal hygiene rules of not smoking, eating or drinking in the work area, and always wash your hands before eating or drinking.

This appliance does not contain any component manufactured from asbestos or asbestos related products.

Refit the glass frame as detailed in section 5.8, then light the appliance as detailed in section 5.4 / 5.5 as applicable.

5.8 REMOVING / RE-FITTING THE GLASS FRAME ASSEMBLY

- a) The glass frame is held in position by hooking the top flange over the combustion chamber opening at the top as shown in figure 20 below.

Fig. 20

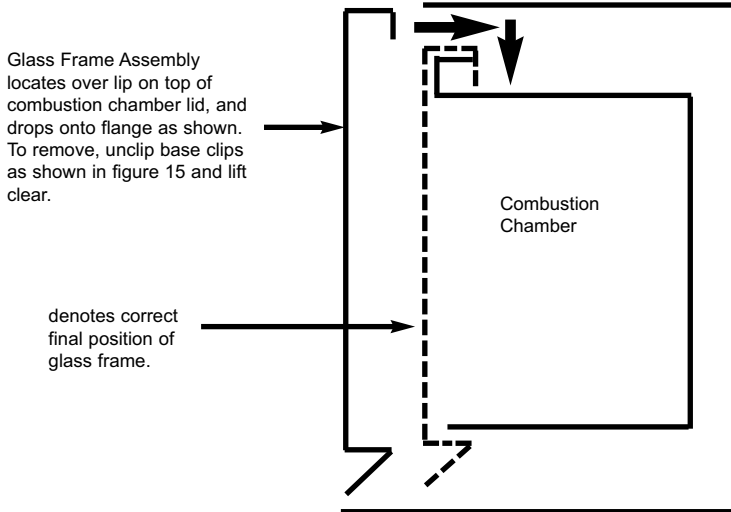

- b) The assembly is then secured to the bottom of the combustion chamber by the two hinge clamp brackets as shown below in figure 21. These are clamped together to form the seal between the glass frame assembly and the combustion chamber.

Fig. 21

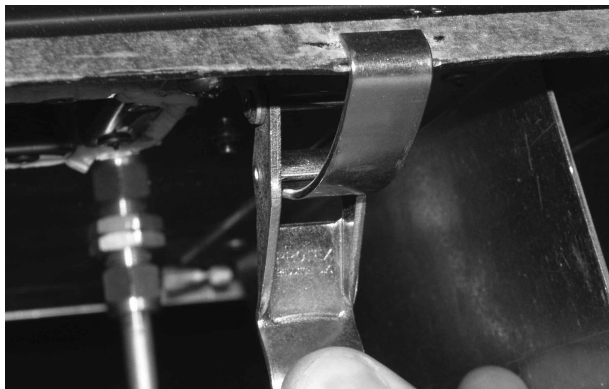

5.9 REMOVAL & RE-FITTING OF THE TRIM ASSEMBLY

IMPORTANT NOTE : The trim assembly of this product is a working surface and as such will become hot in use. Allow the product and trim to fully cool prior to attempting to remove it.

- a) The trim is attached to firebox by 4 off magnets as shown below in figure 22.

Fig. 22

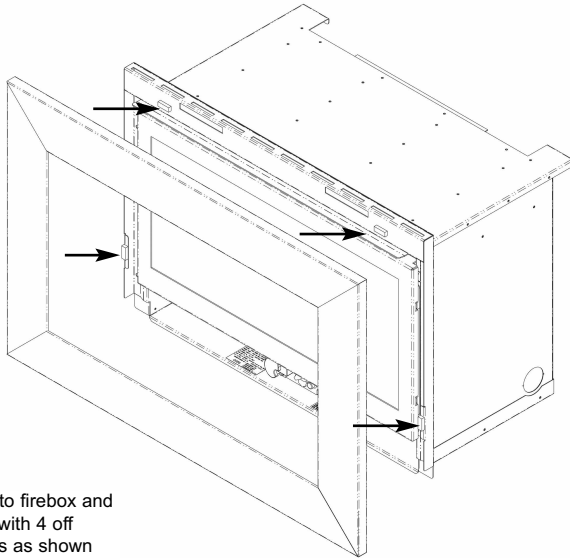

Fit trim to firebox and secure with 4 off magnets as shown

- b) Ensure the trim is securely fitted to the fire.

5.10 USER REPLACEABLE PARTS

The only user replaceable parts on this fire are the fuelbed / log form, and the handset / ultrasonic receiver batteries, which may be replaced as described in the below. Replacement of any other parts must be carried out by a competent person such as a GAS SAFE registered gas installer.

The part numbers of the user replaceable parts are as follows, these are available from specialist spares stockists whose details can be found on our web site, www.bfm-europe.com, in the 'stockist' section.

Complete Ceramic Set inc. 5 logs & bag of loose gravel (All Models)	B-105650
Loose Gravel Set (All Models)	B-105660
Base Log "A" (All Models)	B-105670
Log "B" (All Models)	B-105680
Log "C" (All Models)	B-105690
Log "D" (All Models)	B-105700
Log "E" (All Models)	B-105710

5.11 REPLACING THE BATTERIES IN THE HANDSET

- a) Remove either the 1 off 9V battery or 3 off AAA batteries (dependent upon which remote system is fitted to the product) by removing the cover on the back of the handset.
- b) Refit new battery and replace cover.

5.12 REPLACING THE BATTERIES IN THE FIRE

- a) Remove the trim assembly as detailed in section 5.9
- b) The battery pack on SIT equipped models is at the front of the product in the centre. Replace with 6 off AA batteries. The batteries on the Mertik Maxitrol equipped models are on the left hand side, in the receiver unit. Slide the cover off and replace with 4 off AA batteries.

Due to our policy of continual improvement and development the exact accuracy of descriptions and illustrations cannot be guaranteed

**Part No. B-1004052
Issue 2**



At the heart of your home

BFM Europe Ltd.
Trentham Lakes
Stoke-on-Trent
Staffordshire
ST4 4TJ

www.bfm-europe.com

Telephone - General Enquiries : (01782) 339000

Telephone - Service : (01782) 339008