

Air to Water Heat Pump

Installation manual

Control Kit MIM-E03CN

- Thank you for purchasing this Samsung Product.
- Before operating this unit, please read this installation manual carefully and retain it for future reference.



SAMSUNG

Contents

Safety precautions	3
Product specifications	4
Main components	5
Installing the unit	6
Wiring works	10
Wiring schematics	28
Self-test mode of wired remote controller	29
DHW tank	30
Mixing Valve	34
Concrete curing function	37
Installation option setting	39
Troubleshooting	41
Error codes	44
Reference (KEYMARK Certification)	46



Correct Disposal of This Product (Waste Electrical & Electronic Equipment)

(Applicable in countries with separate collection systems)

This marking on the product, accessories or literature indicates that the product and its electronic accessories (e.g. charger, headset, USB cable) should not be disposed of with other household waste at the end of their working life. To prevent possible harm to the environment or human health from uncontrolled waste disposal, please separate these items from other types of waste and recycle them responsibly to promote the sustainable reuse of material resources.

Household users should contact either the retailer where they purchased this product, or their local government office, for details of where and how they can take these items for environmentally safe recycling.

Business users should contact their supplier and check the terms and conditions of the purchase contract. This product and its electronic accessories should not be mixed with other commercial wastes for disposal.

Safety precautions

Carefully follow the precautions listed as below because they are essential to guarantee the safety of SAMSUNG product.













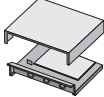

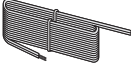
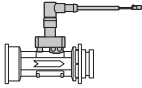
WARNING



- Always disconnect a power supply of Air-Water Heat Pump before servicing it or accessing components inside the unit.
- Verify that installation and testing operations shall be performed by qualified personnel.
- To prevent serious damage on the system and injuries to users, precautions and other notices shall be observed.

Warning

- ▶ Carefully read the contents of this manual before installing the control kit and store the manual in a safe place in order to be able to use it as reference after installation.
- ▶ For maximum safety, installers should always carefully read the following warnings.
- ▶ Store the manual in a safe location and remember to hand it over to the new owner if the kit is sold or transferred.
- ▶ The kit is compliant with the requirements of the Low Voltage Directive (72/23/EEC), the EMC Directive (89/336/EEC) and the Directive on pressurized equipment (97/23/EEC).
- ▶ The manufacturer shall not be responsible for damage originating from unauthorized changes or the improper connection of electric and hydraulic lines. Failure to comply with these instructions or to comply with the requirements set forth in the "Operating limits" table, included in the manual, shall immediately invalidate the warranty.
- ▶ Do not use the units if you see some damages on the units and recognize something bad such as loud noisy, smell of burning.
- ▶ In order to prevent electric shocks, fires or injuries, always stop the unit, disable the protection switch and contact SAMSUNG's technical support if the unit produces smoke, if the power cable is hot or damaged or if the unit is very noisy.
- ▶ Always remember to inspect the unit, electric connections, and protections regularly. These operations shall be performed by qualified personnel only.
- ▶ The unit contains various electric parts, which should be kept out of the reach of children.
- ▶ Do not attempt to repair, move, alter or reinstall the unit by unauthorized personnel, these operations may cause product damage, electric shocks and fires.
- ▶ Do not place containers with liquids or other objects on the unit.
- ▶ All the materials used for the manufacture and packaging of the air to water heat pump are recyclable.
- ▶ The packing materials must be disposed of in accordance with local regulations.
- ▶ Wear protective gloves to unpack, move, install, and service the unit to avoid your hands being injured by the edge of the parts.
- ▶ Do not touch the internal parts while running the units.
- ▶ Inspect the product shipped and check if damaged during transport. If the product has some damages, DO NOT INSTALL and immediately discuss about the damages with the carrier or retailer (if the installer or the authorized technician has collected the material from the retailer.)
- ▶ Our units shall be installed in compliance with the spaces described in the installation manual, to ensure accessibility from both sides and allow repairs or maintenance operations to be carried out. If the units installed without complying with procedures described in manual, additional expenses can be asked because special harnesses, ladders, scaffolding or any other elevation system for repair service will NOT be considered part of the warranty and will be charged to the end customer.
- ▶ When service works required, make sure to disconnect the power supply at least 1 minute to prevent electric shocks.
 - Always check the voltage at the terminals of main PCB before trying to touch.
- ▶ Use electric wires which manual designated. Connections between wires and terminals shall be assembled without any tension. If the assembly works is not implemented well, it can lead to have product damages and fires.
- ▶ After wiring works, terminal block cover shall be fixed firmly. Without cover, it can cause to have product damage and fire.
- ▶ Be sure not to perform power cable modification, midway wiring, and multiple wire connection.
 - It may cause electric shock or fire due to poor connection or insulation and current limit override.
 - When midway wiring is required due to power line damage, refer to "How to connect your extended power cables" in the installation manual.

Product specifications

Item	Description	
	MIM-E03CN	
	Wired remote controller (MWR-WW10N)	
	Temp. Sensor	Temp. Sensor for DHW Tank (15m, YEL) (1EA) Temp. Sensor for Mixing Valve (15m, BLU) (1EA) Temp. Sensor for Heater (15m, BLK) (1EA)
	PV Control / Peak power control cable(Red, 2 m, 1 EA)	
	Flow Sensor (1EA, 1.5m)	
	Sensor holder (2EA, OD 7.8mm)	
	Sensor clip (2EA)	
	Cable tie (4EA)	
	Aluminum tape (2EA)	
	Rubber tape (2EA)	
	Insulator (2EA)	
	LEAD CONNECTOR	Back-up heater connector (Red) Back-up heater connector (Brown) Back-up heater connector (White)
	Installation manual	
	User manual	
	ASSY TUBE CONNECTOR-RIGHT (OD28.0, 1EA)	

Item	Description
	ASSY TUBE CONNECTOR-LEFT (OD28.0, 1EA)
	Fastener (2EA)
	O-Ring (2EA)

* Temp. sensor = Temperature sensor

Main components

Model name	MIM-E03CN	
Detail components	Parts	Qty.
	Main PBA	1
	ELCB - Rated current : 30A - Leakage current : 30mA	1
	Grounding screw	7
	Rubber	3
	Base plate	1
	Top cover plate	1
	Case screw	2
Weight (Net)	3.5 kg	
Packing size (W x H x D)	329 mm x 439 mm x 168 mm	

* Flow sensor set point

AE050RXD**/AE080RXD** : 7LPM

AE120RXD**/AE160RXD** : 12LPM

Mounting the unit

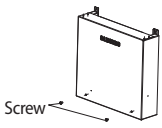
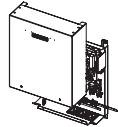
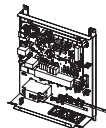
Procedure	Remark
1. Remove 2 screw from the unit.	
2. Open the top cover and install 4 screws on the wall.	
3. Close the top cover and install 2 screw again into the unit.	

Installing the unit

Installing the remote controller

Dimension

(Unit : mm)

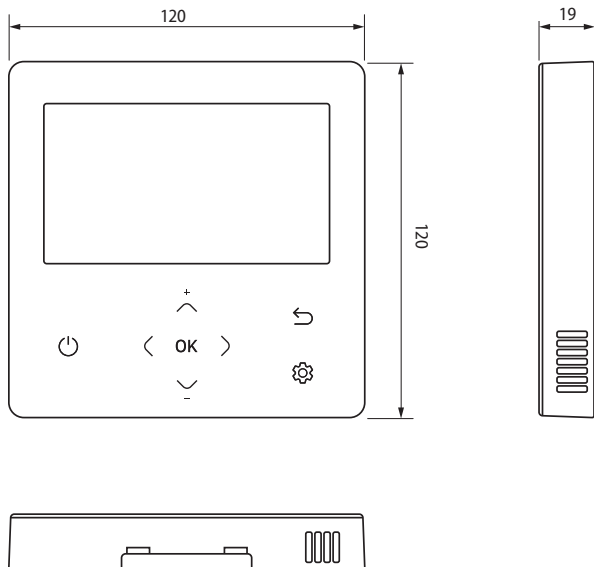

Wired Remote Controller Installation

1. Insert the flat-head screwdriver into two square grooves at the bottom of the Wired Remote Controller and rotate it to lift the front cover for removal from the rear cover.

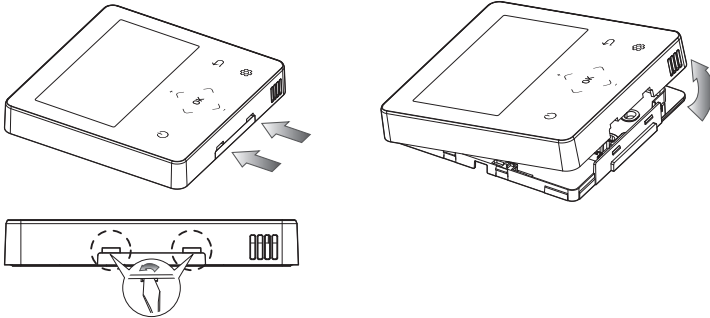

2. Arrange the power cable and the communication cable so that they fit in the housing along the edges of the rear cover.

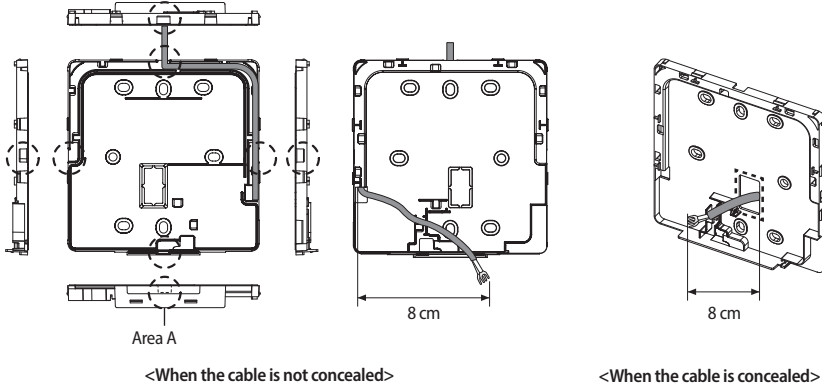

NOTE

- When connecting the power and communication cables to the bottom of the Wired Remote Controller, first cut off the area A.

Installing the unit

- Using two or more screws, firmly affix the rear cover of the remote controller to the wall, and then cut off the grooves of the front covers for communication and power cables, making sure these cables have reasonable length.

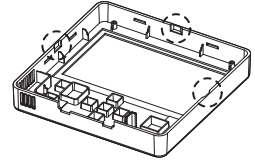
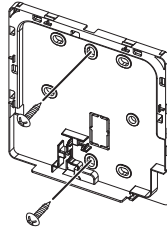
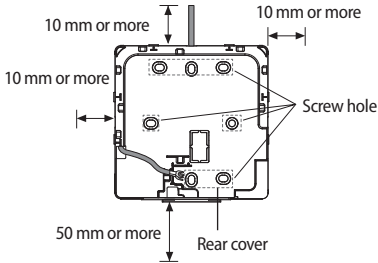

- * Before fixing the rear cover, secure at least 10 mm space of upper side, left side, right side, and 50 mm space of bottom side.

- * You must fit the screws into the screw holes.

- Connect the communication cables (F3, F4) to the terminals of the back of the front cover, and then fix the wires so that they do not get stuck during connection.

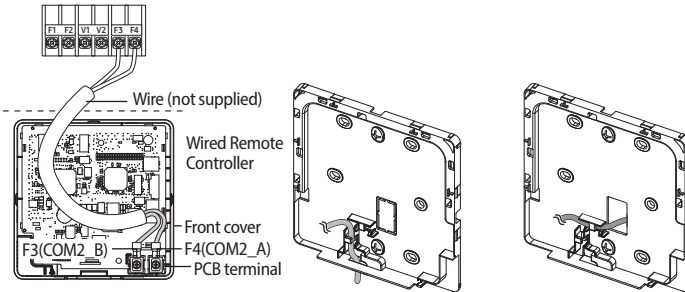

- * Do not tighten the screws on the PCB terminal with excessive force.



- When using an electric screwdriver, tighten the screws to the standard torque because the top of screws may be worn out if you use a strong torque.

- Reassemble the Wired Remote Controller.



- Align the controller with the upper groove first, and then insert it by turning it downwards as shown in the figure. After assembly, check and confirm that no wires are stuck in the gap between the back and front covers.



6. Remove the front protective film.

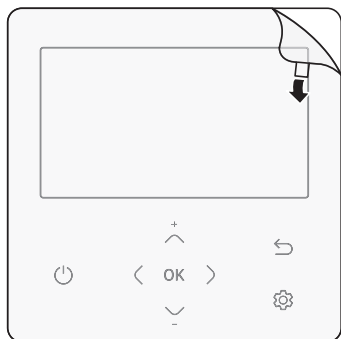

- When installing a Wired Remote Controller by using a cable longer than 10 m, you must install the communication cable and the power cable separately. (Electrical interference can cause the Wired Remote Controller to malfunction.)
- When installing your Wired Remote Controller on the wall, consider the size of the wire hole, and select a wire with a proper thickness.
- Wire that is connectable to Wired Remote Controller PCB.
 - If you install the Wired Remote Controller by reclaiming, install it according to U-terminal cable specification.
 - If you install the Wired Remote Controller by using two pieces of PVC wire, remove the 30 cm of the sheath of the cable and install it only with the two pieces of wires. (Recommended specification: AWG20)
- The following are the specs of the compression ring terminal connected to your Wired Remote Controller PCB.

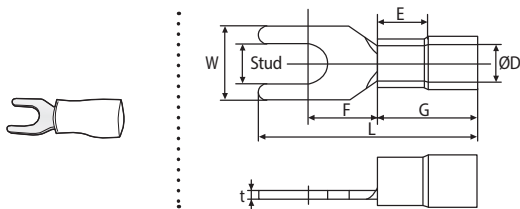

Range of Permitted Wires		Rated Size	Stud Size	Basic Size (mm)						
AWG	mm ²	mm ²	mm	t	øD	G	E	F	W	L
22 ~ 16	0.25 ~ 1.65	1.5	3	0.7	3.8	10.0	4.5	6.5	6.0	21.2

* Maximum distance for connecting communication and power cable: 100 m

- Screws on the PCB terminal must be tightened with less than 6N-cm tightening torque. If the tightening torque is greater, it may damage the screw thread.

Wiring works



- Field-supplied electrical components such as power switch, circuit breakers, wires, terminal blocks, etc must be properly chosen with compliance with national legislation or regulation.
- Switch off the power supply before making any connections.
- All field wiring and components must be installed by a licensed electrician.
- Use a dedicated power supply.
- All power connections must be protected from dew condensation by thermal insulation.
- The system shall be earthed. Do not earth the unit to a utility pipe, surge absorber or telephone earth. Incomplete earth may cause electrical problems.

Layout of PCB

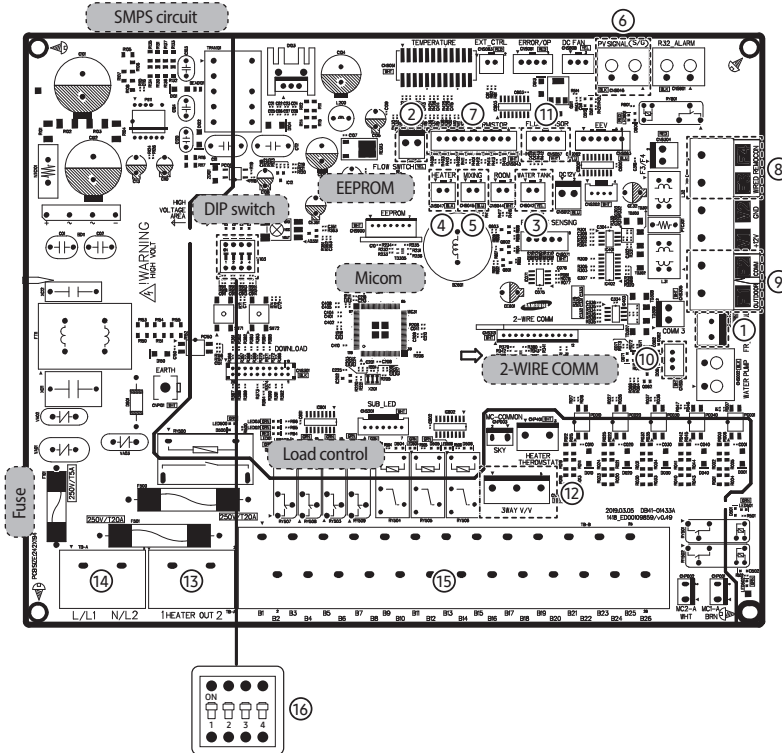

No.	Note	No.	Note
①	FR Control CNS003(Green)	②	Flow Switch CNS041(Yellow)
③	Temp. Sensor for DHW Tank CNS042(Yellow)	④	Temp. Sensor for Heater CNS047(Black)
⑤	Temp. Sensor for Mixing Valve CNS045(Blue)	⑥	PV(Photovoltaic) Control Signal / Peak power control Signal CNS046(Black)

No.	Note	No.	Note			
⑦	Thermistor CNS043(White) 1-2: Heater Out 5-6: Eva In	⑧	TB-C(Black) F3-F4:COMM2 (Wired Remote Controller)			
⑨	TB-C(Black) F1-F2:COMM1 (IN-OUT COMM)	⑩	Water Pump Signal CNS1(White) 1: Signal 3: Gnd			
⑪	Flow Sensor CNS057(White) 1: DC5V 2: Signal 3: Gnd 4: N.C	⑫	3-Way Valve CNP501(White) 1: Neutral 3: Signal_NO 5: Signal_NC			
⑬	Immersion Heater TB-A1(Block) L-N, Output, AC	⑭	Main Power TB-A(Black) L-N, INPUT, AC			
⑮	TB-B(Black)					
	Terminal No.	Function	Input/output	Max. Current	Description	Remark
	B1/B6	Water Pump	AC 230V output	0.5 A	Water INV. pump operation (maximum input power of pump 100W). (B6: Lived)	Mandatory
	B2/B3/B5	Mixing valve	AC 230V output	22 mA	Mixing Valve operation(B2: CW, B3: CCW)	Option
	B4/B5	Backup Boiler	AC 230V output	10 mA	Signal output for Backup Boiler(B5: Neutral)	Option
	B7/B8	Water Pump	AC 230V output	0.5 A	Additional Water pump operation (maximum input power of pump 100W)(B8: Lived)	Option
	B9/B10/ B11/B12	2Way valve #1	AC 230V output	22 mA	2 Way Valve operation for Zone#1 (UFH) (B9: NO, B10: NC, B11: Neutral, B12: Lived)	Option
	B13/B14/B11/ B12	2Way valve #2	AC 230V output	22 mA	2 Way Valve operation for Zone#2 (FCU) (B13: NO, B14: NC, B11: Neutral, B12: Lived)	Option
	B15/B16/B17/ B18	3Way valve	AC 230V output	22 mA	3 Way Valve operation for DHW (B17: NO, B18: NC, B15: Neutral, B16: Lived)	Option
	B19/B20	Thermostats	AC 230V output	22 mA	Power to external thermostat(s) (B20: Lived)	Option
	B21/B22	Thermostat 1	AC 230V input	22mA	Thermostat for zone#1 (UFH) Cooling(B21)/ Heating(B22) Signal	Option
B23/B24	Thermostat 2	AC 230V input	22mA	Thermostat for zone#2 (FCU) Cooling(B23)/Heating(B24) Signal	Option	
B25/B26	Solar Pump	AC 230V input	10 mA	Signal input from Solar Pump / DHW Thermostat (B26: Lived)	Option	
⑯	Dip Switch(K1~K4)					

Wiring works

Selection for the power and booster heater wire terminal

- ▶ Connect the cables to the terminal board using the solderless ring terminal.
 - ▶ Use certified and verified cables.
 - ▶ Connect using a driver which is able to apply the rated torque to the screws.
 - ▶ If the terminal is loose, fire may occur caused by arc.
 - ▶ If the terminal is connected too firmly, the terminal may be damaged.
 - ▶ External force should not be applied to the terminal block and wires.
 - ▶ The cable ties to fasten the wire should be an incombustible material, V0 or above.
- (The cable ties should be used to fasten the power wire and they are supplied with the unit.)

Tightening Torque (kgf · cm)	
M3	0.5 ~ 0.75
M3.5	8 ~ 12
M4	12 ~ 18
M5	20 ~ 30

▶ Main PCB

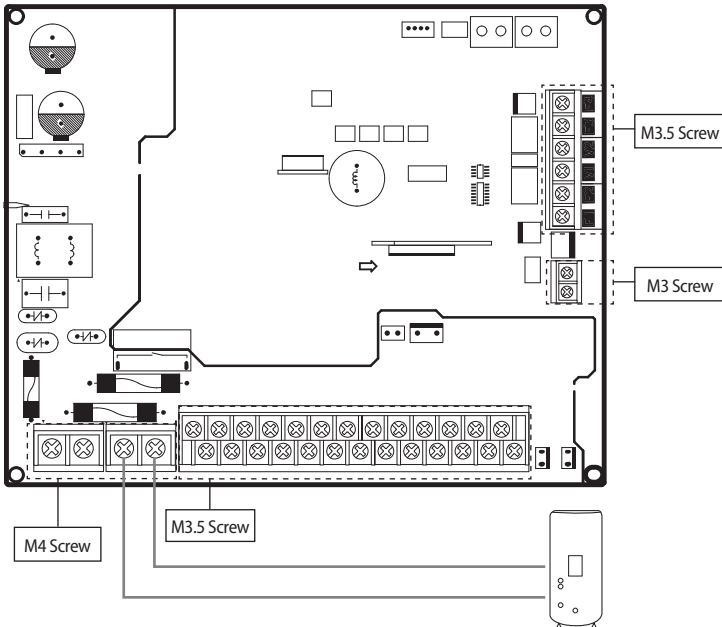

▶ ELCB

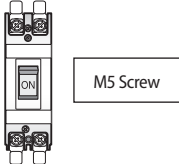

Selecting solderless ring terminal

- ▶ Select a solderless ring terminal of a connecting power cable based on a nominal dimensions for cable.
- ▶ Cover a solderless ring terminal and a connector part of the power cable and then connect it.

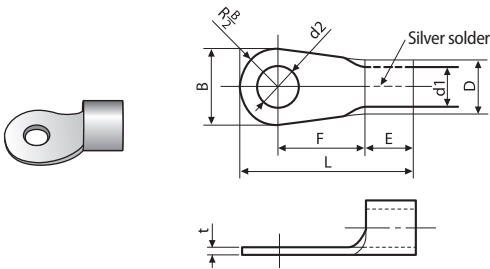





Nominal dimensions for cable (mm ²)		1.5	2.5	4/6		10
Nominal dimensions for screw (mm)		4	4	4	8	8
B	Standard dimension (mm)	8	9.5	9.5	12	12
	Allowance (mm)	±0.2	±0.2	±0.2		±0.2
D	Standard dimension (mm)	3.4	4.2	5.6		7.1
	Allowance (mm)	+0.3 -0.2	+0.3 -0.2	+0.3 -0.2		+0.3 -0.2
d1	Standard dimension (mm)	1.7	2.3	3.4		4.5
	Allowance (mm)	±0.2	±0.2	±0.2		±0.2
E	Min.	4.1	4.1	6		7.9
F	Min.	6	7	5	9	9
L	Max.	16	17.5	20	28.5	30
d2	Standard dimension (mm)	4.3	5.3	4.3	8.4	8.4
	Allowance (mm)	+0.2 0	+0.2 0	+0.2 0	+0.4 0	+0.4 0
t	Min.	0.7	0.8	0.9		1.15

Wiring works

How to connect your extended power cables

1. Prepare the following tools.

Tools	Crimping pliers	Connection sleeve (mm)	Insulation tape	Contraction tube (mm)
Spec	MH-14	20xØ6.5(HxOD)	Width 19mm	70xØ8.0(LxOD)
Shape				

2. As shown in the figure, peel off the shields from the rubber and wire of the power cable.

- Peel off 20 mm of cable shields from the pre-installed tube.



- For information about the power cable specifications for indoor and outdoor units, refer to the installation manual.
- After peeling off cable wires from the pre-installed tube, insert a contraction tube.

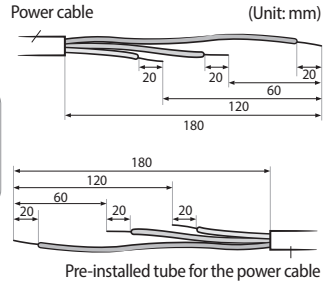

3. Insert both sides of core wire of the power cable into the connection sleeve.

► **Method 1**

- Push the core wire into the sleeve from both sides.

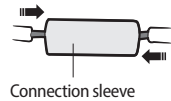

► **Method 2**

- Twist the wire cores together and push it into the sleeve.

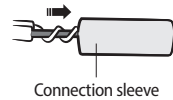

- If cable wires are connected without using connecting sleeves, their contact area becomes reduced, or corrosion develops on the outer surfaces of the wires (copper wires) over a long time. This may cause an increase of resistance (reduction of passing current) and consequently may result in a fire.

4. Using a crimping tool, compress the two points and flip it over and compress another two points in the same location.

- The compression dimension should be 8.0.



- After compressing it, pull both sides of the wire to make sure it is firmly pressed.

► **Method 1**

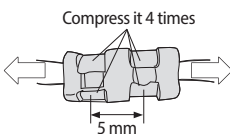

► **Method 2**

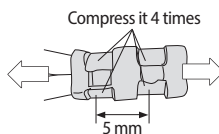

5. Wrap it with the insulation tape twice or more and position your contraction tube in the middle of the insulation tape.

► **Method 1**

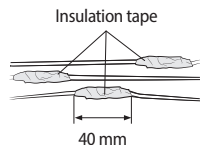

► **Method 2**

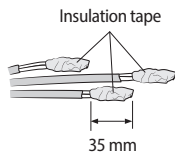

6. Apply heat to the contraction tube to contract it.

► **Method 1**

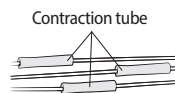

► **Method 2**

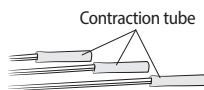

7. After tube contraction work is completed, wrap it with the insulation tape to finish. Three or more layers of insulation are required.

► **Method 1**

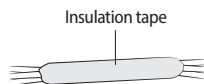

► **Method 2**

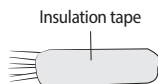

CAUTION

- Make sure that the connection parts are not exposed to outside.
- Be sure to use insulation tape and a contraction tube made of approved reinforced insulating materials that have the same level of withstand voltage with the power cable. (Comply with the local regulations on extensions.)



WARNING

- In case of extending the electric wire, please **DO NOT** use a round-shaped Pressing socket.
- Incomplete wire connections can cause electric shock or a fire.

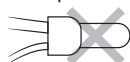

Wiring works

Grounding work

- ▶ Grounding must be done by a qualified installer for your safety.

Grounding the power cable

- ▶ The standard of grounding may vary according to the rated voltage and installation place of a heating pump.
- ▶ Ground the power cable according to the following.

Installation place Power condition	High humidity	Average humidity	Low humidity
Electrical potential of lower than 150V		Perform the grounding work 3. ^{Note 1)}	Perform the grounding work 3 if possible for your safety. ^{Note 1)}
Electrical potential of higher than 150V	Must perform the grounding work 3. ^{Note 1)} (In case of installing circuit breaker)		

* Note 1) Grounding work 3

- Grounding must be done by your installation specialist.
- Check if the grounding resistance is lower than 100 Ω.

When installing a circuit breaker that can cut the electric circuit in case of a short circuit, the allowable grounding resistance can be 30~500 Ω.

* Examples to use cable stripper

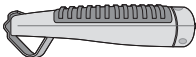

<Cable stripper>

1. Adjust the blade position by coin(the controller is at the bottom side of the tool). Fix the blade position according to the outer sheath thickness of the power cable.
2. Fix the power cable and tool by using the hook at the top side of the tool.
3. Cut out the outer sheath of the power cable by revolving the tool in the direction of the arrow, two or three times.
4. At this situation, cut out the outer sheath of the power cable by moving the tool toward the arrow direction expressed.
5. Slightly bend the wire and pull out the cut part of the outer sheath.

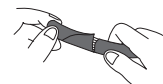
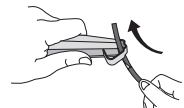
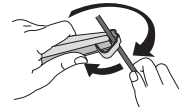
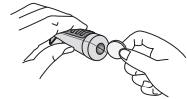

Power and communication with outdoor unit

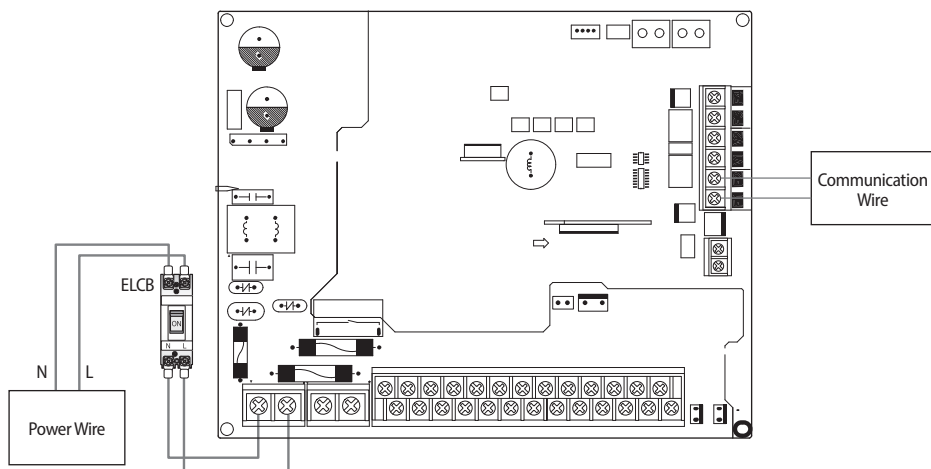

• Be careful when connecting L, N.

Connecting the power wire

1. Connect 'Live' and 'Neutral' power line with 'L, N' of a ELCB.
2. Connect 'L, N' of a ELCB with 'A1 and A2' in TB-A.
3. Connect 'Protective Earth' line with 'Earth screw' In case.

Recommended wire specification

Load	Power Supply	Power Cable	Max. Length
		mm ² , wires	m
Do NOT use Heater (Water Pump, Valve, Wired RMC)	1Ø, 220-240V, 50Hz	1.5 / 3	L < 10m
		2.5 / 3	10m < L
4.0 / 3		L < 10m	
6.0 / 3		10m < L	
Use Booster Heater (Max. 3kW)			

- ▶ The power cable is not supplied with Air to water heat pump.
- ▶ This equipment with "IEC 61000-3-12".
- ▶ Power supply cords of parts of appliances for outdoor use shall not be lighter than polychloroprene sheathed flexible cord. (Code designation IEC:60245 IEC 57 / CENELEC: H05RN-F or IEC:60245 IEC 66 / CENELEC: H07RN-F)
- ▶ When installing the control kit in a computer room or net work room, server room or in the presence of risk of disturbance to the communication cable, use the double shielded (tape aluminium / polyester braid + copper) cable of FROHH2R type.

Wiring works

Connecting the communication wire

- ▶ Connect outdoor unit's F1&F2' with control kit's F1&F2 in TB-C' by 2 core cable.

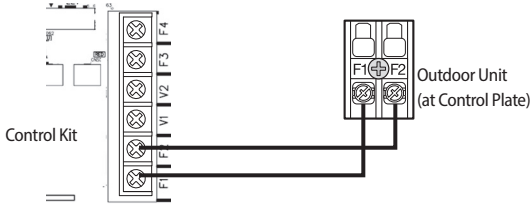

Communication with a wired remote controller (1 unit)

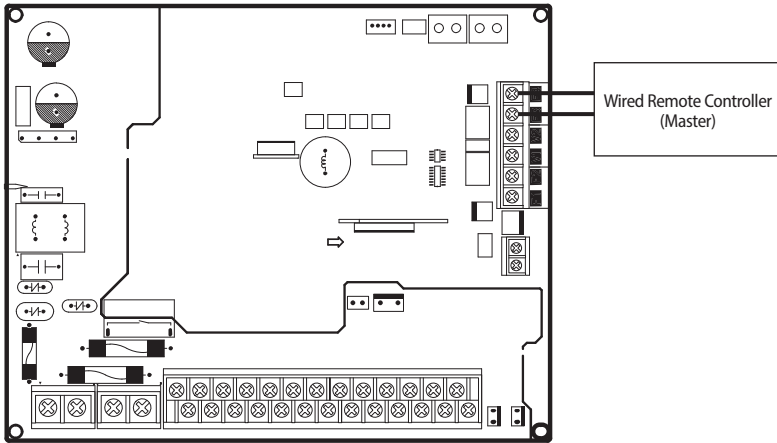

Communication with a wired remote controller (2 units)

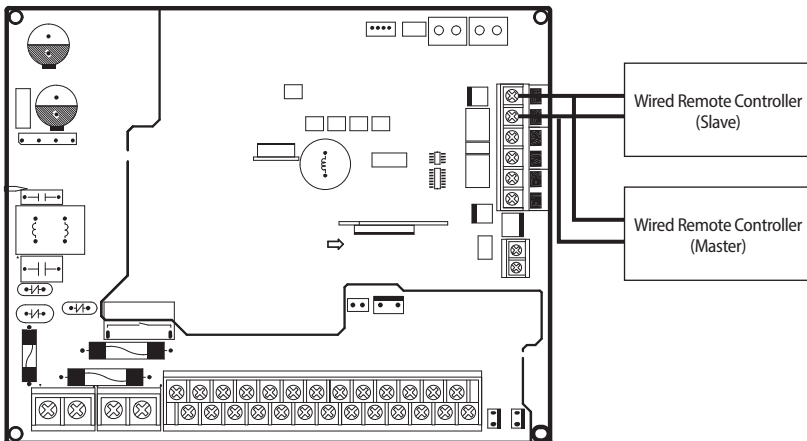

Connecting a wired remote controller

1. Connect 'F3, F4' of TB-C kit with 'F3, F4' of a wired remote controller.
- ▶ 2 units (wired remote controllers) are able to be installed on TB-C.
- ▶ When 2 units are installed, either one shall have "Master" setting and another one shall have "Slave" settings on a wired remote controller.

Temp. Sensor for DHW, Backup heater and a Water Flow Sensor

External wiring to control a switch of relay by a installer

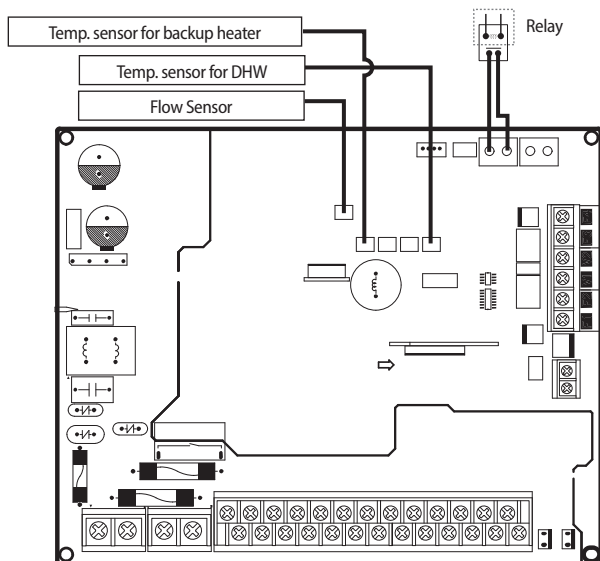

Connecting a temp. sensor wire into DHW

1. Put the sensor side of a temp. sensor wire into the designated location in a DHW.
2. Connect the other side of the line at CNS042.

Connecting a temp. sensor wire to outlet of backup heater

1. Put the sensor side of a temp. sensor wire into the designated location in a backup heater.
2. Connect the other side of the line at CNS047.

Connecting a flow sensor

1. Install a flow sensor in water line.
2. Connect a wire a flow sensor into 'CNS057' connector.

Connecting a PV(Photovoltaic) Signal / Peak power control Signal

1. Install as above diagram.
2. Connect the PV / Peak power control signal wire to the 'CNS046' connector.



NOTE

It operates according to the setting of FSV, and both functions can not be used at the same time. (PV Control / Peak power control)

Wiring works

Backup heater

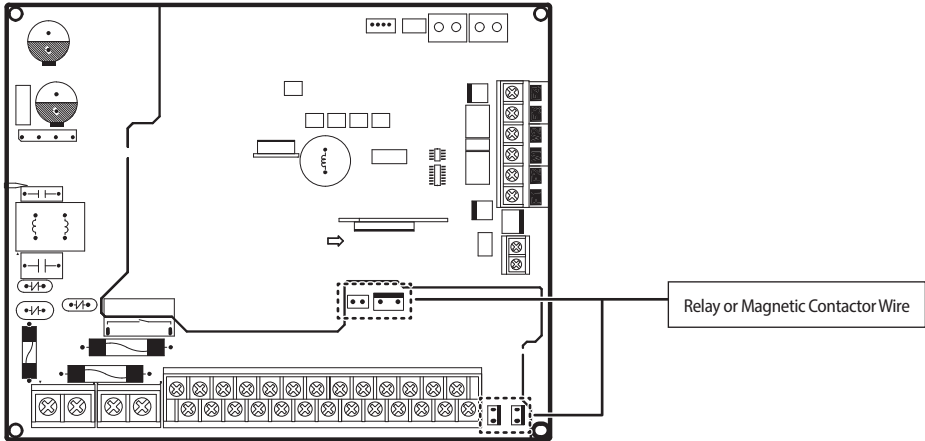

Connecting a relay or a magnetic contactor for a backup heater (Not Directly connect a backup heater)

1. Connect a "relay or a magnetic contactor" with "CNP003,CNP001,CNP002".
 - ▶ When a backup heater mode is "ON" at 1st step, a control signal of AC 230V goes through CNP003 and CNP001.
 - ▶ When a backup heater mode is "ON" at 2nd step, a control signal of AC 230V goes through CNP003 and CNP002..

1st step

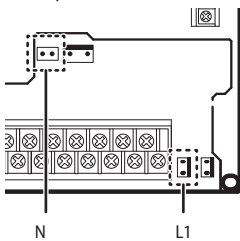

2nd step

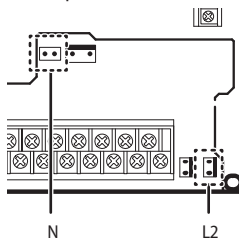

NOTE

This port can NOT supply enough power for driving a backup heater.
It's just for providing a ON/OFF control signal.
Maximum current is 0.5A.

Specification table

Part	Specification
Tab-Terminal (output)	Step1 : CNP003, CNP001 Step2 : CNP003, CNP002
Connection load	Relay or Magnetic contactor for a control signal
Output(CNP003,CNP001 or (CNP003,CNP001)+(CNP003,CNP002)	AC 230V (MAX 0.5A)

ENGLISH

Backup boiler

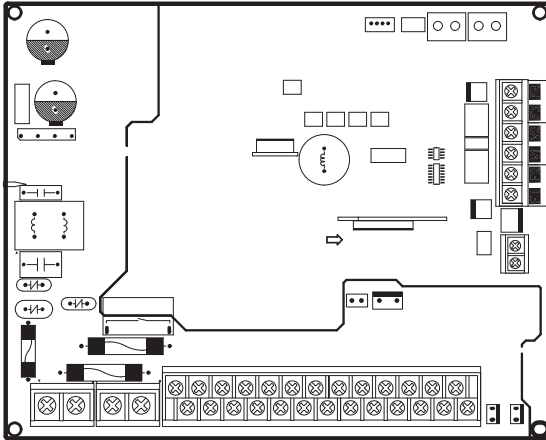

Connection of the back-up boiler

Description	No. of wires	Min. / Max. current	Thickness	Supply Scope
Back-up Boiler	2+ground	10mA / 50mA	0.75mm ² H05RN-F or H07RN-F	Field supply (220-240V~, Input)



B5 : Neutral (N)
B4 : Back-up boiler (L)

When it set back up boiler on the control kit (relay off)

When it order to back up boiler operates (relay on)

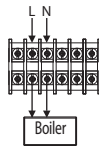
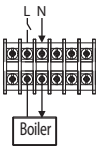

1. Before the installation, control kit should be turned off.
 2. Using the appropriate equipment to correct position of terminal block as shown on the diagram.
 3. Make sure EXT-CTRL signal of back up boiler must be 220-240V~.
 - Do not connect supply power of back up boiler directly.
- * Heat pump does not work when the Back-up boiler operates.

Wiring works

Connection guide of additional pump

Case 1) INV. pump

Connect the PWM control external type pump to PWM terminal block and power cable to the external contact terminal. The maximum number of additional pump installation is one inverter pumps (Input power 100W).

1. Power supply (For additional INV. Pump)

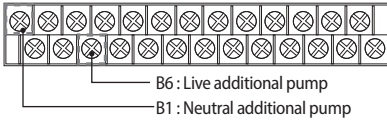

2. PWM control (For additional INV. Pump only), refer to page 29

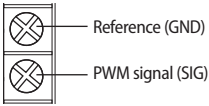

- If there is wrong wiring between PWM and reference, INV. Water Pump may not work or wrong operation.

PWM characteristic curve

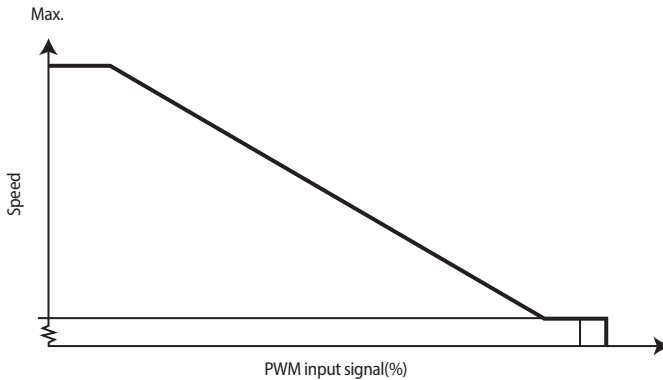

The additional pump should be the same type of product as the above graph.
5~16kW : GRUNDFOS UPMM 25-95 (Heating Type)

Case 2) AC pump

The maximum number of additional pump installation is one AC pumps (Input power 100W).

1. Power supply (AC Pump)

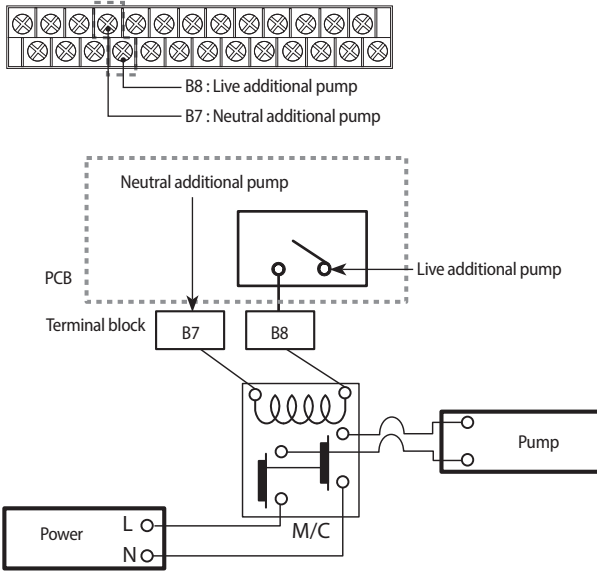

- Terminal of this product is for additional water pump and the maximum allowable current is 0.5 A.

Wiring works

Connection of the 2-way valve

Description	No. of wires	Min. / Max. current	Thickness	Supply Scope
Motorized 2-way valve to shut off UFH loops during cooling.	2+ground	10mA / 50mA	> 0.75 mm ² , H05RN-F or H07RH-F	Field supply (220-240V~, Output)

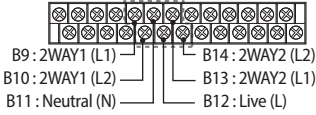

* Connection of 2 wires 2-way valve

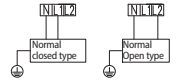

In case of normal closed type

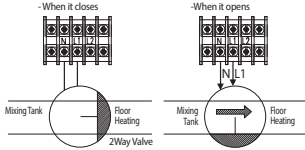

In case of normal open type

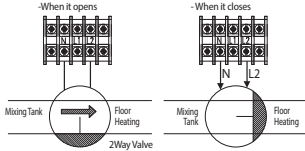

2-way motorized valve

- ▶ When outlet water temperature reach to lower than 16 °C in cooling mode, UFH loops will be closed.
 - ▶ 220-240V~
 - ▶ 2 wires(Normal Open or Normal Close)
1. Before the installation, control kit should be turned off.
 2. Using the appropriate equipment to correct position of terminal block as shown on the diagram.
 3. Make sure what type is you use.
 - Normal OPEN or Normal CLOSED.



- There are 2 types of 2-way valve, normal open type and normal closed type. Make sure to connect terminals to right positions of terminal block. As detailed on the wiring diagram and illustrations above.

Connection of the 3-way valve

Description	No. of wires	Min. / Max. current	Thickness	Supply Scope
Diverting type 3way valve	4	10mA / 50mA	> 0.75 mm ² , H05RN-F or H07RN-F	Field supply (220-240V~, Input)

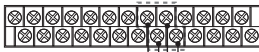

B15: Neutral (N)
B16: Live (L)
B18: 3WAY (L2)
B17: 3WAY (L1)

Status	L1	L2
A (Initial)	OFF	ON
B	ON	OFF

3-way diverting valve for water tank

- ▶ Diverting type cooling mode, UFH loops will be closed.
 - ▶ 220-240V~
1. Before the installation, control kit should be turned off.
 2. Using the appropriate equipment to correct position of terminal block as shown on the diagram.
 3. Make sure what type of 3 way V/V you use.

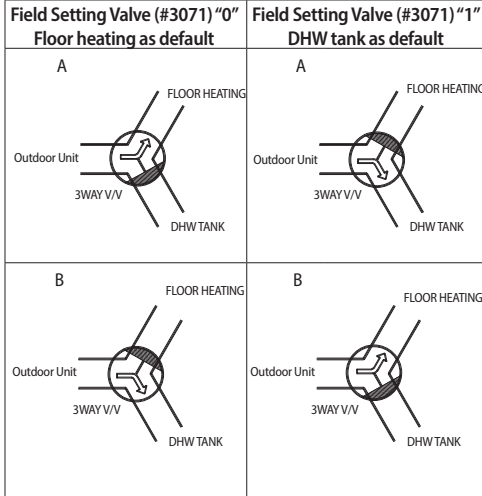

Connection of the thermostat

Description	No. of wires	Max. current	Thickness	Supply Scope
Room Thermostat	4	22mA	> 0.75 mm ² , H05RN-F or H07RH-F	Field supply (220-240V~, Input)

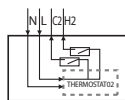
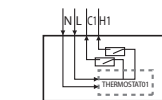
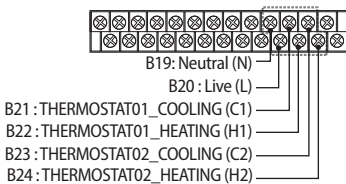

1. Before the installation, control kit should be turned off.
2. Using the appropriate equipment to correct position of terminal block as shown on the diagram.
3. Make sure what type is you use.
 - Contact signal must be "L". When you install two thermostats, thermostat2 is prior to thermostat1.



Product will not operate when signal for cooling and heating mode is inputted at the same time.

Wiring works

Example

zone#1 only : cooling mode

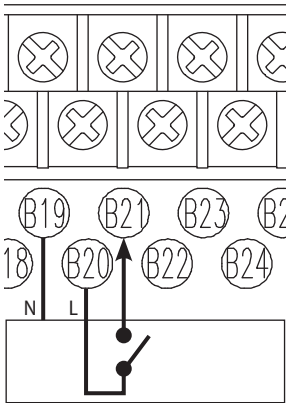

Room thermostat

zone#2 only : cooling mode

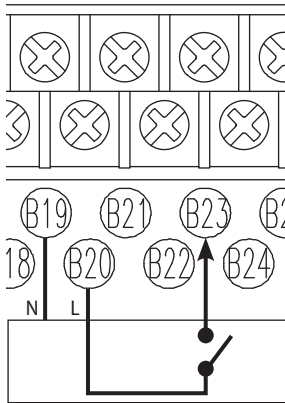

Room thermostat

zone#1, zone#2 : cooling mode

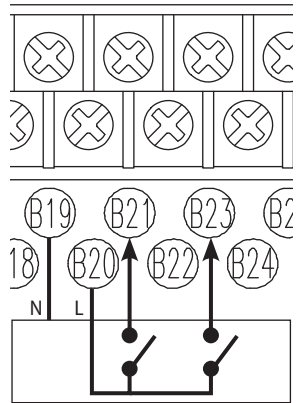

Room thermostat

zone#1 only : heating mode

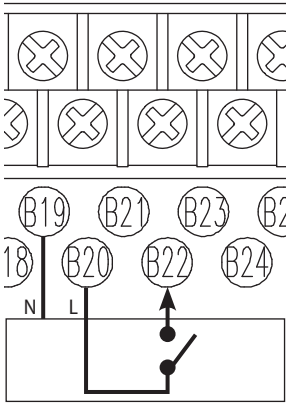

Room thermostat

zone#2 only : heating mode

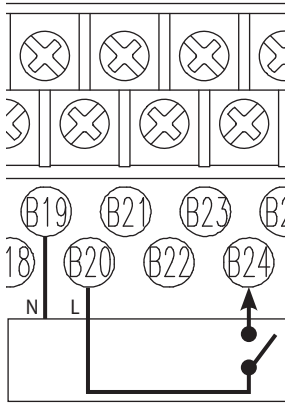

Room thermostat

zone#1, zone#2 : heating mode

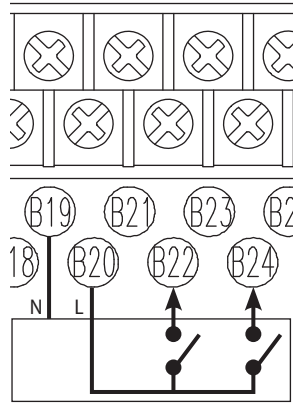

Room thermostat



- Before completing installation of Room thermostat, check the wiring method in a manual of Room thermostat to output L line.

Target zone	Zone 1
Thermostat on/off controller's output signal	Only Heat

- ▶ Connect a thermostat on/off controller's power to B19, B20 and connect output of a thermostat on/off controller to B22.

Example of RX1 (Danfoss)

- ▶ In manual of a RF receiver

RX1 and RX2

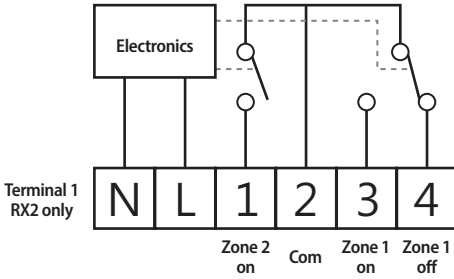

- ▶ Example of wiring works

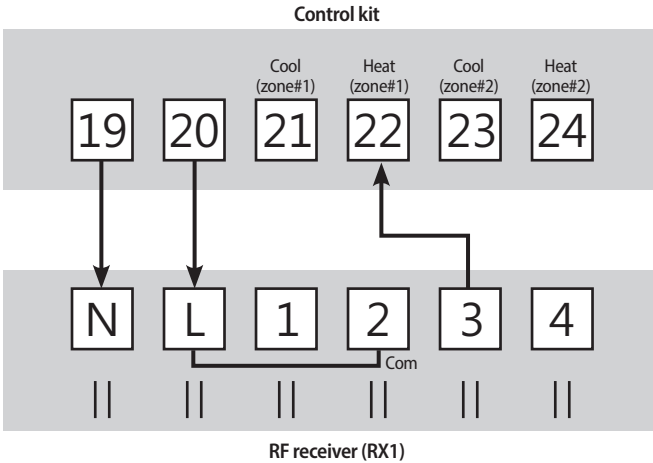

Wiring schematics

Wiring diagram

[OPTION]

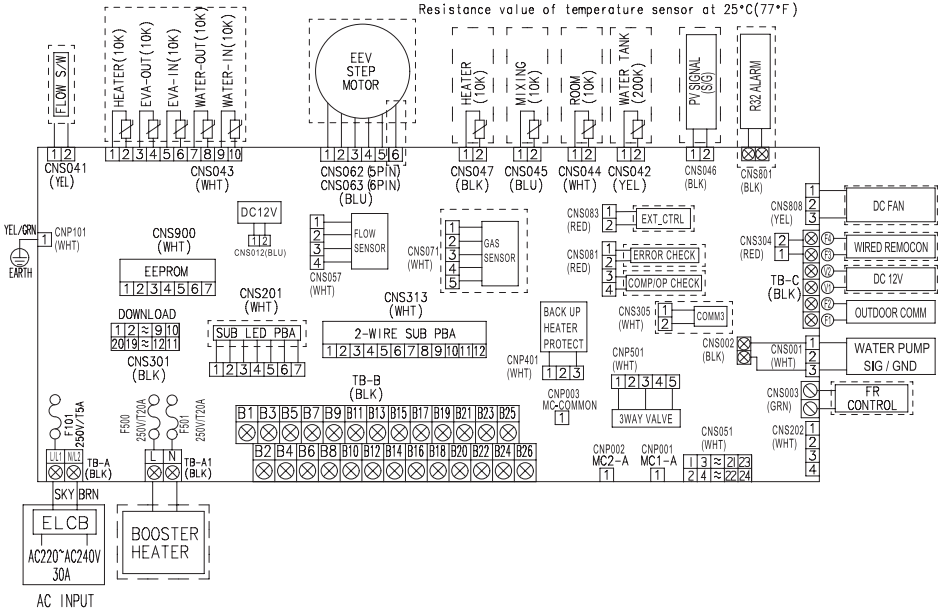

It does not support external input(output) signal function.

NOTE

Self-test mode of wired remote controller

Use of self-test mode

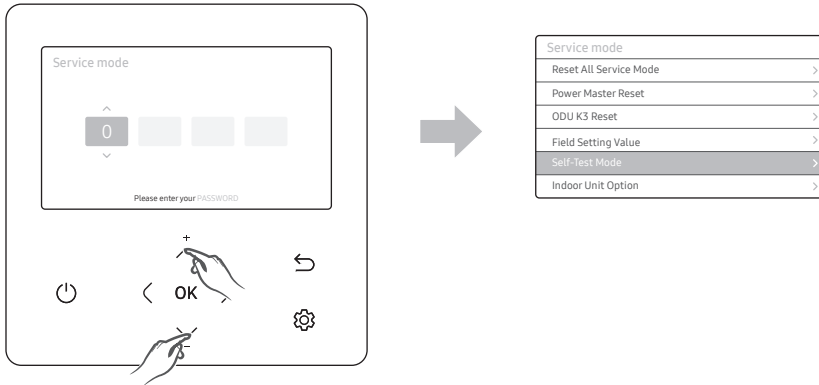

1. If you want to use the various additional functions for your Wired Remote Controller, press the \wedge and \vee buttons at the same time for more than 3 seconds.
 - ▶ The password entry screen appears.
2. Enter the password, "0202," and then press the OK button.
 - ▶ The settings screen for installation/service mode appears.
3. Select Self-Test Mode in Service Mode.
4. Self-Test Mode consists of Self-Test Mode Display that shows operation value status and menus that can turn each component on or off.

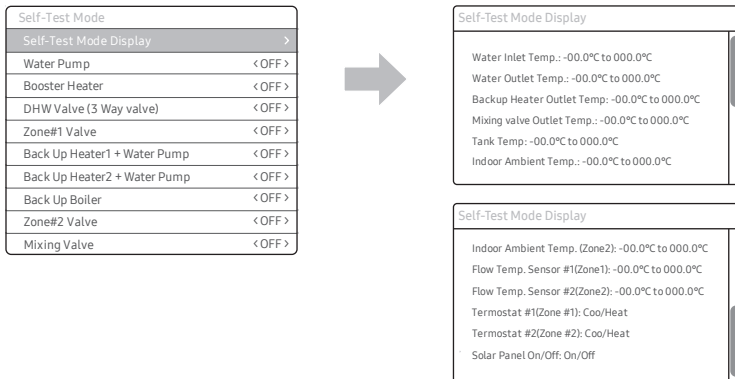

DHW tank

Electrical connections

Procedure



- Switch off the power supply before making any connections.
- Use a thermal grease in thermistor pocket after installing electric connections.

Connections to be made in the electrical box of DHW tank

1. Connect the booster heater power supply and thermal protection cable.
2. Make sure to ensure strain relief of the cable.

Connections to be made in the electrical box of indoor units

3. Plug the thermistor cable connector in the connector CNS042 on the pcb.
4. Connect the booster heater power supply and thermal protection cable(field supply) to terminal TB-A1 and earth on the terminal block.
5. Connector the loose ends of the TB-A1 on the terminal block and the connector CNS042 on the PCB.
6. Plug the thermistor cable connector in the socket X9A on the PCB.
7. Connect the booster heater power supply and thermal protection cable (field supply) to terminal 7, 8, 21, 22 and earth on the terminal block.
8. Connect the booster heater power supply cable to the circuit breaker and earthing screw.
9. Fix the cables to the cable tie mountings with cable ties to ensure strain relief.



- It is of great importance that the heater is filled with water before the electricity is hooked up, or else- the warranty is not valid. If the heater is installed and not used, it must be flushed with water once a week.

Connection of the solar circulation pump / DHW Thermostat for DHW tank

Description	No. of wires	Max. current	Thickness	Supply Scope
Solar pump / DHW Thermostat	2+ground	10 mA	0.75mm ² H05RN-F or H07RN-F	Field supply (230V~, Input)



B25: SOLAR PUMP / DHW Thermostat (N)
B26: SOLAR PUMP / DHW Thermostat (L)

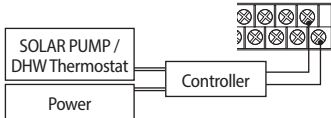

Solar pump operates when FSV 3061=1 is set, and DHW Thermostat operates when FSV 3061=2 is set.

1. Before the installation, control kit should be turned off.
2. Using the appropriate equipment to correct position of terminal block as shown on the diagram.
3. It is for control kit to inform that the Solar pump / DHW Thermostat is operating.
4. Solar pump / DHW Thermostat is controlled by installer's handling. And it send the signal to control kit depending on Solar pump / DHW Thermostat conditions. In operating mode, signal shall be around 230Vac B/W N&L. In non-operating mode, signal shall be around 230Vac B/W N&L. When solar pump signal is On, Control kit DHW mode will be turned off.



- Maximum allowable current of each terminal is below 10 mA.
- Ports number B25, B26 are for input port for detection and they do not supply power to a Solar pump / DHW Thermostat.

Booster heater

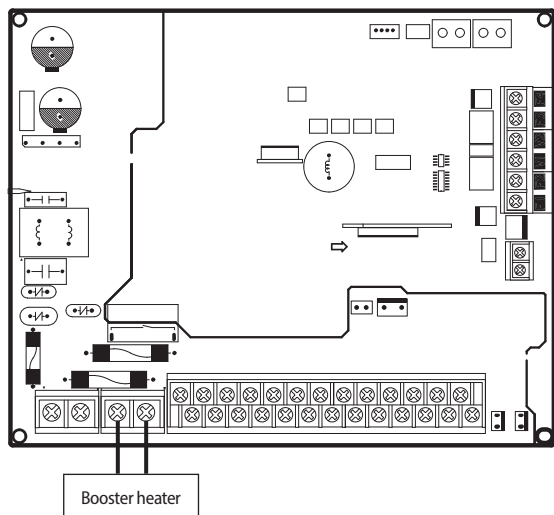

Recommended wire specification

Load	Power Supply	Power Cable	Max. Length
		mm ² , wires	m
Use Booster Heater (Max. 3kW)	1Ø, 220-240V, 50Hz	4.0 / 3	L < 10m
		6.0 / 3	10m < L

* Code designation IEC: 60245 IEC 57 / CENELEC: H05RN-F

Connecting a booster heater (PTC heater – allowed limit : Max. 3kW)

1. Directly connect a 'Booster heater' with 'A3 and A4' in TB-A.



- Wire spec : 6.0 mm² (regardless of distance)
- Code designation IEC : 60245 IEC 57 / CENELEC : H05RN-F

Specification table

Part	Specification
Terminal Block (output)	N, L of TB-A1
Connection load	Direct connection a booster heater
Output (N, L)	AC 230V (MAX 20A)

DHW tank

DHW tank Switch box layout

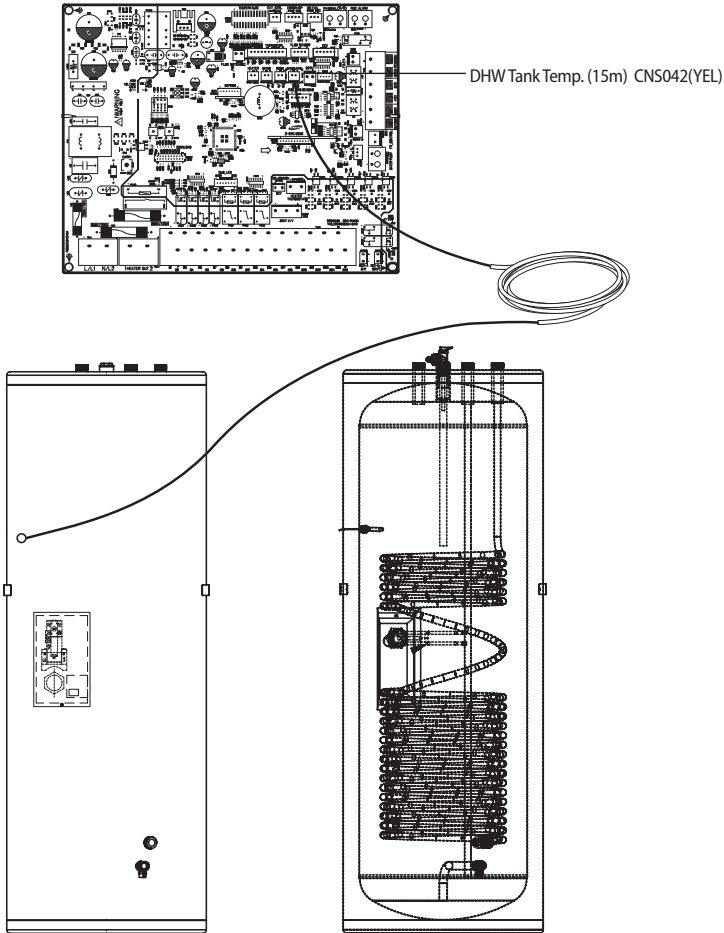

- * Use a correct sensor pocket which is fit for the DHW tank sensor(OD Ø6).
If the gap between the supplied sensor and DHW tank sensor pocket is big, use thermal grease.



NOTE

- When you set the hot water supply temperature to 55°C or less, do not use the booster heater.
- The heatpump and the booster heater operate until the initial set temperature is reached. After that, only the booster heater may operate depending on the settings.

Troubleshooting

IMPORTANT: All maintenance or repair work must be executed by an approved installer.

Problem	Possible cause	Solution
Hot water is not coming out.	No power supply to the water heater	Check if there is any power on the power supply terminal on the thermostat.
	The thermostat may be set too high and cause the fuse or safety cut-off to operate.	Reduce thermostat setting by 5 °C and press the reset button.
Heating is not working	Heating element or internal electrical wiring is out of order.	Check if there is any power on the power supply on the connector of the heating element between black and yellow/green wires. If this is OK, press the reset button on the fuse/safety cut-off.
Water is not warm enough	Thermostat is set too low.	Adjust the thermostat up using a standard screwdriver.
	Heating element or the internal electrical wiring is partially out of order.	Check the resistance of the heating element on the connector of the heater bundle, and the condition of the internal wiring.
	UX mixing valve(fitted on top) is incorrectly adjusted.	Adjust the UX mixing valve correctly to the preferred temperature.
Safety valve(SV) is dripping.	Water expands when heated. If there is no consumption of hot water over a period of time pressure builds up, causing the safety valve to open.	If drip from the SV is severe, it might need to be replaced. Some dripping is normal. Alternatively an expansion vessel can be fitted.
Leak warning outlet is dripping.	The heating element may not be properly tightened.	Check the heating element o-ring seal and all connections.
	There may be a leak.	
Other problems, or if none of the above solves the problem.	-	Contact the installer/supplier regarding any other failure.



WARNING

Incorrect handling of thermostat, safety valve or other valves may lead to tank rupture. When servicing the unit follow instructions carefully:

- Always turn off main power supply when water supply is being shut off.
- Test the free operation of the safety valve regularly by opening the valve ensuring the water flows freely.
- Electrical connection and all servicing of the electrical components should only be carried out by an authorized electrician.
- Fitting and all servicing of plumbing fixtures should only be carried out by an authorized installer.
- When replacing the thermostat, safety valve or any other valve or part supplied with this unit, use only approved parts of the same specification.



CAUTION

- Before resetting the safety cut-off or altering the thermostat setting, always remember to isolate the electrical supply to the unit. This must be done prior to removing the electrical box lid.
- If the electric element or thermostat is defective, contact authorized electrician.
- After adjustments are completed, ensure the lid to the electrical box is refitted correctly and that the retaining screw is properly fitted.

Mixing Valve

Installation of mixing valve

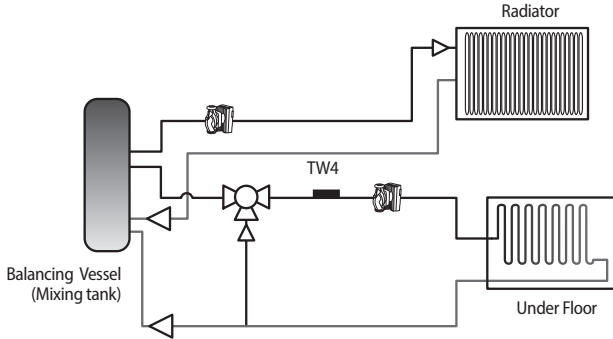

When two different zones are used with different temperature, adjust the temperature of discharge water to high temperature water and control the amount of bypass to provide low temperature water by applying the mixing valve and temperature sensor of the mixing valve (TW4).

1. Select a mixing valve from the manufacturers as below (recommended) and install it at the entrance of the zone.
2. Install the supplied temperature sensor (TW4) on the rear part of the mixing valve. Install TW4 Sensor within 1m of Mixing Valve.
3. Since running time varies depending on the manufacturer, set the FSV (default 90 sec.) by referring to the FSV value below.

Maker		BELIMO	SIEMENS	HONEYWELL
Model code	3 Way Valve	R3020-6P3-S2	VXP45.20-4 (kvs 4)	V5011E1213
	Actuator	LR230A(-S)	SSB31	ML6420A3015
Running time		90 sec.	150 sec.	60 sec.
FSV(#4046) setting		9	15	6

* The table above is for your reference. It can be changed without advanced notice.

4. Set the FSV value by referring to the table below depending on installation environment.

Function	Details	Code	Unit	Default	Min.	Max.
Mixing valve	Use or not	4041	-	0(No)	0	2
	Target temperature difference (Heating) (TW2-TW4)	4042	°C	10	5	15
	Target temperature difference (Cooling) (TW4-TW2)	4043	°C	10	5	15
	Control factor	4044	-	2	1	5
	Interval of valve control	4045	Min.	2	1	30
	Running time (10 second unit)	4046	(x10) sec	9	6	24

* 4041 = 1 : Controlled based on the temperature difference (4042, 4043)

* 4041 = 2 : Controlled based on the temperature difference of the WL value

ex)
Heating

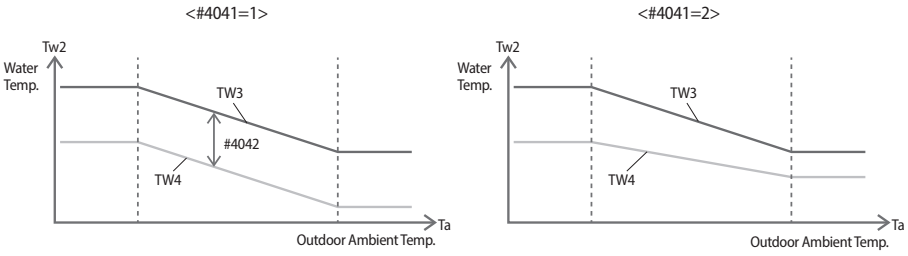

- * The mixing valve is controlled based on the FCU WL value.
- * As the #4044 value increases and the #4045 value decreases, the control speed increases. (Temperature hunting may occur if the control speed increases depending on the load.)
- * The additional pump and mixing valve should be purchased separately. TW4 sensor is included in the product accessories.
- * TW2 : Water temp. sensor 2

CAUTION • When the thermostat control is set as 'Use', the mixing valve can be used for Zone 1 and Zone 2. (When both FSV #2091 and #2092 are set as 1)

Connection of the mixing valve

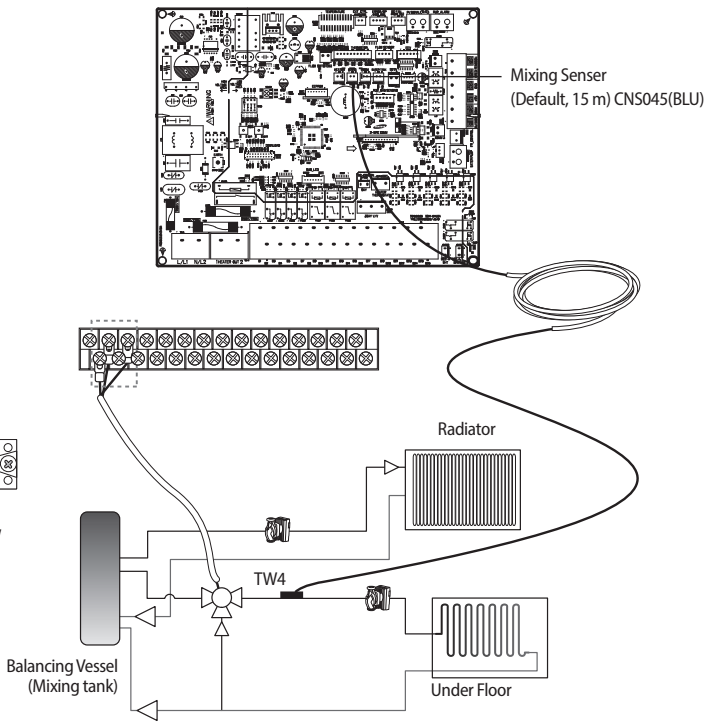

- 2: Mixing Valve_CW
- 3: Mixing Valve_CCW
- 5: Neutral

Mixing Valve

Description	No. of wires	Max. current	Thickness	Supply Scope
Mixing valve	4	22 mA	> 0.75 mm ² , H05RN-F or H07RH-F	Field supply (230V~, Input)

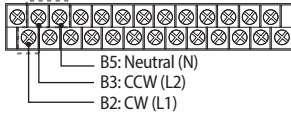

1. Before the installation, control kit should be turned off.
2. Using the appropriate equipment to correct position of terminal block as shown on the diagram.

Example of sensor installation (TW3 / TW4)

Weld the sensor holder on the selected location of the pipe and then insulate it.

When the pipe is a copper pipe

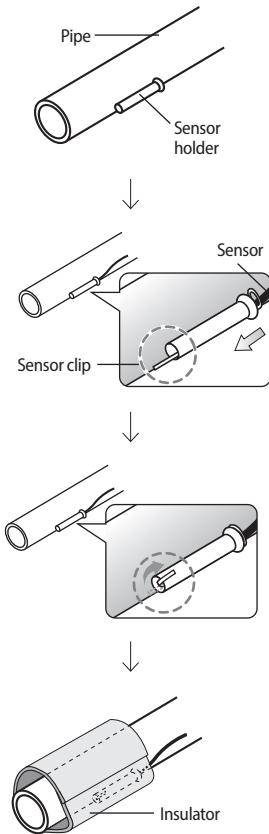

When the pipe is not a copper pipe

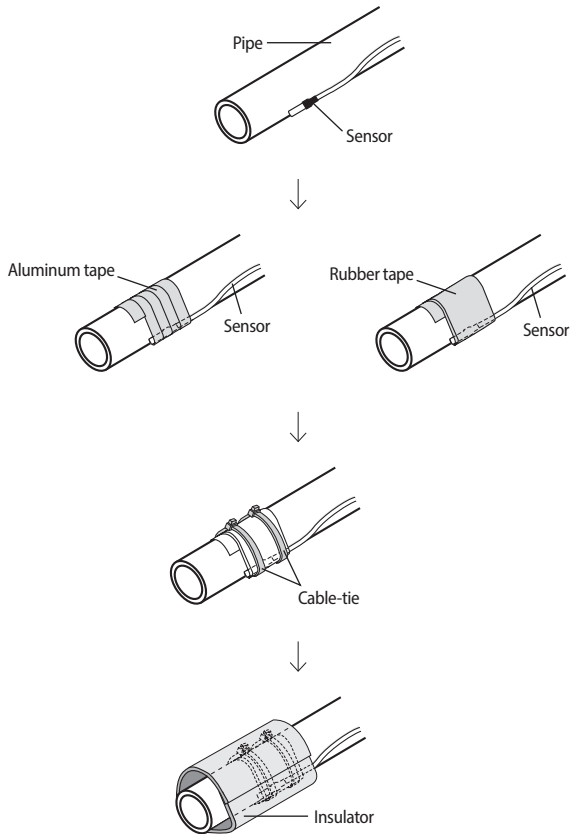

• When the holder sensor cannot be welded on the pipe, fix the sensor with aluminum tape and insulate it.

Concrete curing function

When pipes of floor heating are installed, operation for reinforcing concrete curing is applied. (Period of operation: 23 days)

Entering procedure

1. After turning off the DIP switch K3 (3rd switch of SW03) of control kit (Default ON), turn off and turn on the control kit. The operation for concrete curing starts automatically. (If blackout occurs and communication restarts later, operation will continue.)
2. Temperature of discharge water is controlled as time goes on like below.

[Temp.]

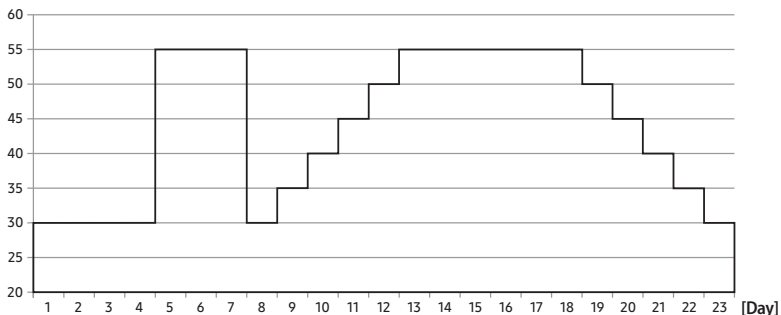

Classification	Initial Heating		Step raise					Heating	Step down					Total (Hour)
Time	96	72	24	24	24	24	24	144	24	24	24	24	24	552
Temperature	30	55	30	35	40	45	50	55	50	45	40	35	30	-

3. Remaining days are displayed on the wired remote controller during operation but key operation is unavailable.

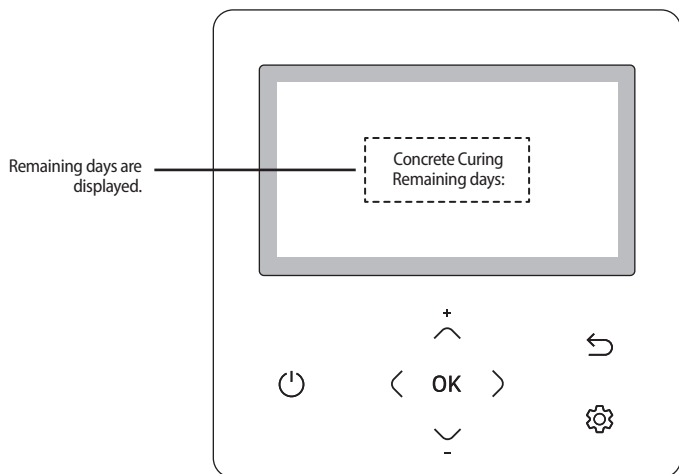

* If an error is displayed, concrete curing function does not work.

Concrete curing function



NOTE

- Definition of Dip switch function

Dip S/W	S/W #1	S/W #2	S/W #3	S/W #4
ON (default)	• None	• None	• None	• Turn off when an E101 error occurs
OFF	• Emergency heating	• Emergency hot water supply	• Concrete curing	• E101 error does not turn off
reference item	• Please refer to the user manual		• Please refer to the previous page	• Please refer to below

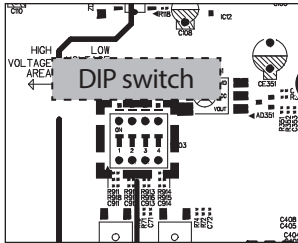

- When outdoor unit only power supply change by local condition, it is an option to auto restart system.

Classification		When the outdoor unit is power off	When the outdoor unit is power on
Hydro Unit operation according to the DIP S/W #4 setting	ON (default)	• Hydro Unit E101 error occurs.	• Hydro Unit E101 error disappears. • Hydro Unit operation turns off.
	OFF	• Hydro Unit E101 error occurs.	• Hydro Unit E101 error disappears. • Hydro Unit keeps its previous operation.

- The outdoor unit on/off control is not available with the A2A indoor unit.
- Although the outdoor unit is turned on after the E101 error occurred, the A2A indoor unit operation keeps turned off.

Installation option setting

- ▶ Set the control kit installation option with remote controller option.

The procedure of option setting

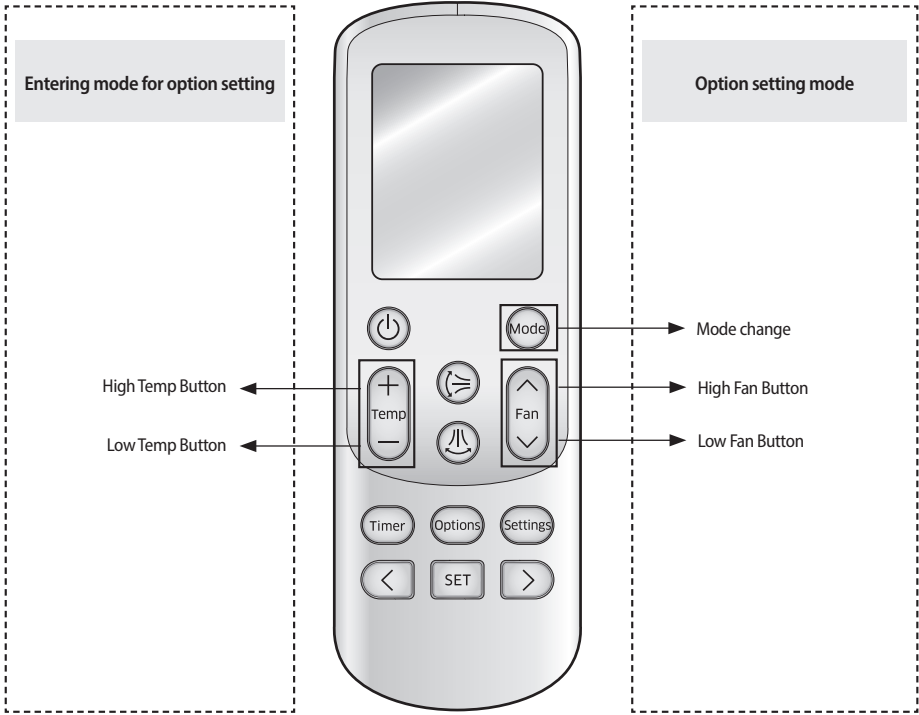

Entering mode to set option

1. Remove batteries from the remote controller.
2. Insert batteries and enter the option setting mode while pressing High Temp button and Low Temp button. 

3.  Check if you have entered the option setting status.

Installation option setting

Changing a particular option

You can change each digit of set option.

Option	SEG1		SEG2		SEG3		SEG4		SEG5		SEG6	
Explanation	PAGE		MODE		The option mode you want to change		The tens' digit of an option SEG you will change		The unit digit of an option SEG you will change		The changed value	
Remote Controller Display												
Indication and Details	Indication	Details	Indication	Details	Indication	Details	Indication	Details	Indication	Details	Indication	Details
	0		D		Option mode	1~6	Tens' digit of SEG	0~9	Unit digit of SEG	0~9	The changed value	0~F



- When changing a digit of an control kit address setting option, set the SEG3 as 'A'.
- When changing a digit of control kit installation option, set the SEG3 as '2'.

NOTE

Ex) When setting the 'central controller' into disuse status.

Option	SEG1	SEG2	SEG3	SEG4	SEG5	SEG6
Explanation	PAGE	MODE	The option mode you want to change	The tens' digit of an option SEG you will change	The unit digit of an option SEG you will change	The changed value
Indication	0	D	2	0	5	0

* 02 Series installation option

Classification	SEG1~24
Use central controller (Default)	020010 100000 200000 300000
Disuse central controller	020000 100000 200000 300000

* 01 Series Production Option (Factory default)

Mode 1	SEG1~24
MIM-E03CN	012300 100000 200000 300000

Troubleshooting

If the unit has some problem to work properly, some error codes will be displayed on the controller. The following table described the explanation of error codes on the LCD display.

Thermistor

- ▶ Check its resistance. 10kohm@25 °C (Control kit), 200kohm@25 °C (DHW Tank, Solar)
- ▶ Check its location as shown at the diagram.
- ▶ Check its contact status with pipe.
- ▶ Final solution is to change parts

Display	Explanation
120	Short- or open-circuit error of the room temperature sensor of the Zone 2 indoor unit (detected only when the room thermostat is used)
121	Short- or open-circuit error of the room temperature sensor of the Zone 1 indoor unit (detected only when the room thermostat is used)
653	Wired remote controller thermistor SHORT or OPEN
901	Water Inlet thermistor SHORT or OPEN
902	PHE Outlet thermistor SHORT or OPEN
903	Water outlet (Back up Heater) temp sensor SHORT or OPEN (The Backup heater for using)
904	Water TANK thermistor SHORT or OPEN
906	Outdoor Eva Inlet Temp Sensor SHORT or OPEN
916	Mixing Valve thermistor SHORT or OPEN

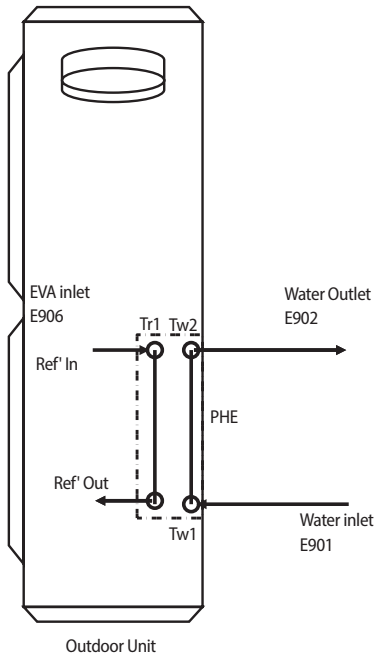

Outdoor Unit

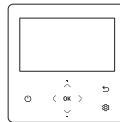

Wired remote controller temp sensor
E653



Water tank temp sensor
E904

Troubleshooting

Communication

Display	Explanation
E01	Communication error between remote controller and the Control kit
E04	Tracking error between remote controller and the Control kit
E54	Memory(EEPROM) Read/Write Error(Wired remote Controller data error)

E601, E604

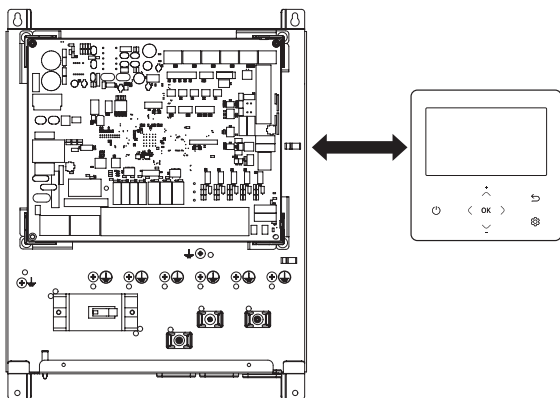

E654

MEMORY(EEPROM) Read/Write Error (Wired controller data error)

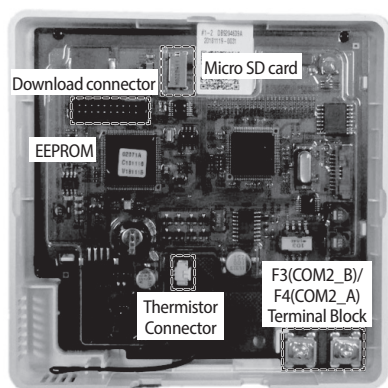

Water pump & Flow Sensor

Display	Explanation
9 1 1	Low flow rate error <ul style="list-style-type: none">• in case of low flow rate in 30 sec during water pump signals is ON(Starting)• in case of low flow rate in 15 sec during water pump signals is ON(After starting)
9 1 2	Normal flow rate error <ul style="list-style-type: none">• in case of normal flow rate in 10min during water pump signal is OFF

E911

- ▶ Water pump ON (Low flow rate) : NOT enough water flow

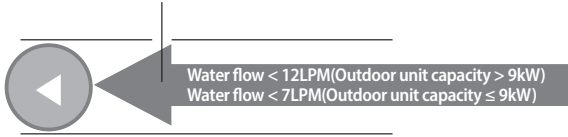

E912

- ▶ Water pump OFF (Normal flow rate)

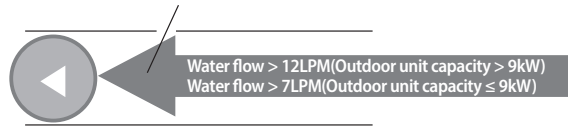

Error codes

If the unit has some problems and does not work normally, error code is shown on the OUTDOOR UNIT main PBA or LCD of the wired remote controller.

Display	Explanation	Error Source
101	CONTROL KIT / OUTDOOR UNIT wire connection error	CONTROL KIT, OUTDOOR UNIT
120	Short- or open-circuit error of the room temperature sensor of the Zone 2 indoor unit (detected only when the room thermostat is used)	CONTROL KIT
121	Short- or open-circuit error of the room temperature sensor of the Zone 1 indoor unit (detected only when the room thermostat is used)	CONTROL KIT
162	EEPROM Error	CONTROL KIT
198	Error of Terminal Block's Thermal Fuse(Open)	CONTROL KIT
201	CONTROL KIT/OUTDOOR UNIT communication error (Matching error)	CONTROL KIT, OUTDOOR UNIT
202	CONTROL KIT/OUTDOOR UNIT communication error (3 min)	CONTROL KIT, OUTDOOR UNIT
203	Communication error between INVERTER and MAIN MICOM (6 min)	OUTDOOR UNIT
221	OUTDOOR UNIT temperature sensor error	OUTDOOR UNIT
231	Condenser temperature sensor error	OUTDOOR UNIT
251	Discharge temperature sensor error	OUTDOOR UNIT
320	OLP sensor error	OUTDOOR UNIT
403	Detection of OUTDOOR UNIT compressor freezing (During cooling operation)	OUTDOOR UNIT
404	Protection of OUTDOOR UNIT when it is overload (during Safety Start, Normal operation state)	OUTDOOR UNIT
407	Comp down due to high pressure	OUTDOOR UNIT
416	Discharge of a compressor is overheated	OUTDOOR UNIT
425	Power source line missing error (only for 3-phase model)	OUTDOOR UNIT
440	Heating operation blocked (outdoor temperature over 35°C)	OUTDOOR UNIT
441	Cooling operation blocked (outdoor temperature under 9°C)	OUTDOOR UNIT
458	OUTDOOR UNIT fan1 error	OUTDOOR UNIT
461	[Inverter] Compressor startup error	OUTDOOR UNIT
462	[Inverter] Total current error/PFC over current error	OUTDOOR UNIT
463	OLP is overheated	OUTDOOR UNIT
464	[Inverter] IPM over current error	OUTDOOR UNIT
465	Compressor V limit error	OUTDOOR UNIT
466	DC LINK over/low voltage error	OUTDOOR UNIT
467	[Inverter] Compressor rotation error	OUTDOOR UNIT
468	[Inverter] Current sensor error	OUTDOOR UNIT
469	[Inverter] DC LINK voltage sensor error	OUTDOOR UNIT

Display	Explanation	Error Source
470	Outdoor unit EEPROM Read/Write Error	OUTDOOR UNIT
471	Outdoor unit EEPROM Read/Write Error(OTP error)	OUTDOOR UNIT
474	IPM(IGBT Module) or PFCM temperature sensor Error	OUTDOOR UNIT
475	OUTDOOR UNIT fan2 error	OUTDOOR UNIT
484	PFC Overload Error	OUTDOOR UNIT
485	Input current sensor error	OUTDOOR UNIT
500	IPM is overheated	OUTDOOR UNIT
554	Gas leak error	OUTDOOR UNIT
601	Communication error between the CONTROL KIT and wired remote controller	Wired Remote Controller
602	Wired remote controller Master/Slave setting error	Wired Remote Controller
604	Communication tracking error between the CONTROL KIT and wired remote controller	CONTROL KIT, Wired Remote Controller
607	Communication error between the Master and Slave wired remote controllers	Wired Remote Controller
899	Short- or open-circuit error of the Zone 1 water-out temperature sensor	CONTROL KIT
900	Short- or open-circuit error of the Zone 2 water-out temperature sensor	CONTROL KIT
901	Water inlet (PHE) temperature sensor error(open/short)	OUTDOOR UNIT
902	Water outlet (PHE) temperature sensor error(open/short)	OUTDOOR UNIT
903	Water outlet (backup heater) temperature sensor error.	CONTROL KIT
904	DHW tank temperature sensor error	CONTROL KIT
906	Outdoor evaporator inlet temperature sensor (open/short)	OUTDOOR UNIT
911	Low flow rate error <ul style="list-style-type: none"> • in case of low flow rate in 30 sec during water pump signals is ON(Starting) • in case of low flow rate in 15 sec during water pump signals is ON(After starting) 	CONTROL KIT
912	Normal flow rate error <ul style="list-style-type: none"> • in case of normal flow rate in 10min during water pump signal is OFF 	CONTROL KIT
916	Mixing valve temperature sensor (open/short)	CONTROL KIT
919	Error that the set temperature for disinfection operation is not reached, or, after reaching, the temperature fails to continue for the requested time	CONTROL KIT

Reference (KEYMARK Certification)

Model code Outdoor	Model code Indoor	Registration number	Accessory* Mono Control Kit
AE050RXYDEG/EU	AE200RNWMEG/EU	007-CU0101	
AE050RXYDEG/EU	(space heating only)		MIM-E03CN
AE080RXYDEG/EU	AE200RNWMEG/EU	007-CU0102	
AE080RXYDEG/EU	(space heating only)		MIM-E03CN
AE080RXYDEG/EU	AE260RNWMEG/EU	007-CU0103	
AE080RXYDGG/EU	AE260RNWMGG/EU		
AE080RXYDGG/EU	(space heating only)		MIM-E03CN
AE120RXYDEG/EU	AE200RNWMEG/EU	007-CU0104	
AE120RXYDEG/EU	(space heating only)		MIM-E03CN
AE160RXYDEG/EU	AE200RNWMEG/EU		
AE160RXYDEG/EU	(space heating only)		MIM-E03CN
AE120RXYDEG/EU	AE260RNWMEG/EU	007-CU0105	
AE120RXYDGG/EU	AE260RNWMGG/EU		
AE120RXYDGG/EU	(space heating only)		MIM-E03CN
AE160RXYDEG/EU	AE260RNWMEG/EU		
AE160RXYDGG/EU	AE260RNWMGG/EU		
AE160RXYDGG/EU	(space heating only)		MIM-E03CN

Memo

Samsung, PO Box 12987, Blackrock, Co. Dublin. Ireland
or Blackbushe Business Park, Yateley, GU46 6GG. UK



This appliance is
filled with R-32.