

# heatmiser®



Model: Touch V2

# Model: Touch V2





# Table of Contents

Product Image	1	Locking/Unlocking the Touch V2	24
Table of Contents	2	Holiday	25
What is a Programmable Room Thermostat?	3-4	Optional Settings Explained	26-27
Installation Procedure	5-6	Optional Settings - Feature Table	28
Mode Select	7	Adjusting the Optional Settings	29
<b>Mode 1 - Thermostat</b>	<b>8</b>	Fail Safe/Modbus	30
LCD Display	9-10	Recalibrating the Touch V2	31
Power On/OFF	11	Error Codes	31
Setting the Time & Date	12	Wiring Diagrams	32-35
Temperature Display	13	<b>Mode 2 - Time Clock</b>	<b>36</b>
Pairing Accessories	14-15	LCD Display	37-38
View Accessories	16	Setting the Switching Times	39
Removing Accessories	17	Timer Advance	40
Edit Comfort Levels	18-19	Timer Override	41
Temperature Control	20	Optional Settings Explained	42
Temperature Hold	21	Optional Settings - Feature Table	42
Advance	22	Adjusting the Optional Settings	43
Frost Protection	23	Replacing the Battery	44

## What is a Programmable Room Thermostat?

A programmable room thermostat is both a programmer and a room thermostat.

A programmer allows you to set “On” and “Off” periods to suit your own lifestyle.

A room thermostat works by sensing the air temperature, switching on the heating when the air temperature falls below the thermostat setting, and switching it off once this set temperature has been reached.

So a programmable room thermostat lets you choose what times you want the heating to be on, and what temperature it should reach while it is on. It will allow you to select different temperatures in your home at different times of the day (and days of the week) to meet your particular needs and preferences.

Setting a programmable room thermostat to a higher temperature will not make the room heat up any faster. How quickly the room heats up depends on the design and size of the heating system.

Similarly reducing the temperature setting does not affect how quickly the room cools down. Setting a programmable room thermostat to a lower temperature will result in the room being controlled at a lower temperature, and saves energy.

The way to set and use your programmable room thermostat is to find the lowest temperature settings that you are comfortable with at the different times you have chosen, and then leave it alone to do its job.

The best way to do this is to set the room thermostat to a low temperature – say 18°C, and then turn it up by 1°C each day until you are comfortable with the temperature. You won't have to adjust the thermostat further. Any adjustment above this setting will waste energy and cost you more money.

You are able to temporarily adjust the heating program by overriding or using the temperature hold feature. These features are explained further on pages 20 and 21 of this manual.

Programmable room thermostats need a free flow of air to sense the temperature, so they must not be covered by curtains or blocked by furniture. Nearby electric fires, televisions, wall or table lamps may also prevent the thermostat from working properly.



## Installation Procedure



### Do

Mount the Touch V2 at eye level.

Read the instructions fully so you get the best from our product.



### Don't

Do not install near to a direct heat source as this will affect functionality.

Do not push hard on the LCD screen as this may cause irreparable damage.

*This thermostat is designed to be flush mounted and requires a back box of 35mm (minimum depth) to be sunk into the wall prior to installation.*

### Step 1

Using a small screwdriver, slightly loosen the screw from the bottom face of the thermostat. You can then carefully separate the front half from the back plate.

### Step 2

Place the Touch V2 LCD front plate somewhere safe.

Terminate the Touch V2 as shown in the diagrams on page 32-35 of this booklet.

### Step 3

Screw the Touch V2 back plate securely into the back box.

### Step 4

Replace the front of the thermostat onto the back plate, by locating the pins in the socket then insert the top edge first. Now push in the bottom edge, securing it in place with the retaining screw.

1



2



3

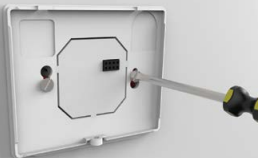

4













## Mode Select

The Touch V2 can either be used as a thermostat or a time clock. Thermostat mode is the default setting.

To change between thermostat & time clock modes, follow these steps.

- Press and **hold** the  key for 3 seconds .....   
*At this point the screen will go blank showing only , 'CLOCK' and 'SETUP'.*
- Press and **hold** 'SETUP' for 10 seconds .....   
*The Touch V2 will factory reset then provide 2 selectable mode options.*
- Use the Left / Right keys to scroll between modes .....    
Mode 1 = Thermostat  
Mode 2 = Time Clock  
*Note: the selected option will flash.*
- Press 'DONE' to confirm selection ..... 
- Press the  key once .....   
*The Touch V2 will reset all parameters and restart in the selected mode.*

*Note: The Mode Select function will reset all parameters (**Wireless Air Sensors and Window/Door Contacts excluded**) that were entered during the set-up operations. These processes must be repeated after the restart has completed.*



# 1 Mode 1 - Thermostat



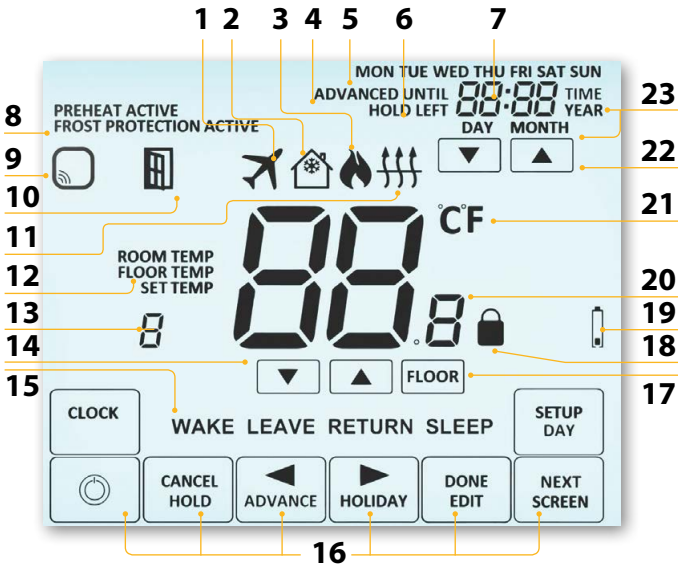

1. Holiday – Displayed when the thermostat is in holiday mode.
2. Frost Protection – Displayed when frost protection is enabled or activated by a Window/Door Switch.
3. Flame Symbol – Displayed when the thermostat is calling for heat and flashes when optimum start is active.
4. Advanced Until - Displayed when the Touch V2 is advanced to the next programmed comfort level.
5. Day Indicator - Displays the day of the week.
6. Hold Left - Displayed when a temperature hold is active, the remaining time will be shown.
7. Clock - Time displayed in 24 hour format.
8. Active Status - Indication for 'Preheat' and 'Frost Protection' modes.
9. Sensor Warning - Flashes on screen when the Touch V2 has failed to receive a signal from a Wireless Sensor or Window/Door Switch.
10. Window Icon - Displays when Window/Door Switch is triggered.
11. Floor Limit Symbol – Displayed when the floor probe has reached the floor temperature limit configured in the setup menu.
12. Floor/Room Temp & Set - Indicates the displayed sensor mode and when changes are being made to the current set point.
13. Program Indicator - Displayed during programming (6 level mode) to show which level is being altered.
14. Up/down keys – Increase/decrease of lower digit group.
15. Program Indicator - Displayed during programming (4 level mode) to show which level is being altered.
16. Navigation/Programming keys – Used to configure the Touch V2.
17. View Floor Temperature Key - Used to change display to show floor temperature.
18. Keypad Lock Indicator – Displayed when the keypad is locked.
19. Accessory Low Battery indication – indicates if an attached accessory such as a window switch, has a low battery.
20. Temperature – Displays the current sensor temperature.
21. Temperature Format - Degrees Celsius or Fahrenheit.
22. Up/down keys – Increase/decrease of higher digit group.
23. Time/Day/Month/Year - Displays when setting the Clock/Calendar or a Holiday Period.



## Power On/Off

The heating is indicated ON when the flame icon is displayed.

When the Flame Icon is absent, there is no requirement for heating to achieve the set temperature but the Touch V2 remains active.

To turn the Touch V2 off completely, press and **hold** the  key for approximately 3 seconds until the display goes blank .....



The display and heating output will be turned OFF.

To turn the Touch V2 back **ON**, press the  key .....



Thermostat completely OFF















Thermostat powered ON





## Setting the Time and Date

To set the clock, follow these steps.

- Press and **hold** the  key for 3 seconds .....   
*At this point the screen will go blank showing only , 'CLOCK' and 'SETUP'.*
- Tap the 'CLOCK' key ..... 
- The 'Hour' digits will now flash .....
- Use the 'Up/Down' arrow keys followed by 'NEXT' to set the 'Hours' .....    

- Use the 'Up/Down' arrow keys followed by 'NEXT' to set the 'Minutes' .....    
*Repeat the previous two steps to set the date ('Day, Month & Year').  
Display will go blank once completed.* 
- Press the 'DONE' key followed by  to return to the main display .....   

# Temperature Display

The Touch V2 can be configured for different sensor options such as built in sensor, floor sensor or both. The display will clearly indicate which sensor is being used by showing either 'ROOM TEMP' or 'FLOOR TEMP' to the left the actual value.



**Room Temperature**



**Floor Temperature**

When the Touch V2 is set to use both the air & the floor sensor, the room temperature will be displayed by default.

To view the current floor temperature, press the FLOOR key.

the floor temperature will be displayed for 10 seconds .....

**FLOOR**



## Pairing Accessories

**Wireless Air Sensor. Door/Window - Wireless Contact Sensor**  
(Not available in Time Clock mode).

You can pair a total of 16 accessories to a single Touch V2 thermostat.

### Wireless Air Sensor

Once a remote sensor is added, the Touch V2 will automatically display an average temperature between the 'Wireless Air Sensor' and the on-board sensor inside the thermostat. Averaging will also be calculated between multiple Air Sensors.

### Window/Door Wireless Contact Sensor

If any one of the 'Window/Door' contacts is broken, the Touch V2 thermostat will be alerted and will activate 'Frost Protection' mode.

The display will now show the icon (right) to indicate a window or door has been opened. Heating will not resume while this icon remains on screen.



### Pairing the Air Sensor and Window/Door Contact.

- Press and **hold** the  key for 3 seconds to turn off the display .....
- Press the 'Setup' key .....
- Press 'Down' key until you see the letter 'P' displayed at the top of the screen then press 'NEXT' .....



*The thermostat will now start a 99 second countdown. During this time multiple sensors can be added.*

Number of accessories connected.



Countdown time

- On the 'Air Sensor & Window/Door Contact', press and hold the pairing button for 5 seconds. The LED will glow red to indicate pairing status

#### Window/Door Wireless Contact Sensor

#### Wireless Air Sensor

Pair/Reset button



LED Indicator



Pair/Reset button

*If the sensor has successfully paired, the LED will go out after a few seconds. The thermostat display will then show '01:P' to indicate that the first accessory has joined. If countdown time elapses before all accessories have been paired, restart the countdown to add further sensors following the previous steps.*





## View Accessories

- Press and **hold** the  key for 3 seconds to turn off the display .....
- Press the 'Setup' key .....
- Press 'Down' key until you see the letter 'A' displayed at the top of the screen then press 'NEXT' .....



SETUP



NEXT

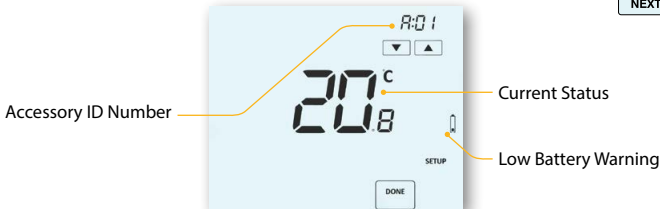

Example showing 'Wireless Air Sensor'.

- Use the 'Up/Down' arrow keys to scroll through the list of attached accessories .....



A 'Wireless Air Sensor' will show the current temperature. The 'Window/Door Contact' will display current open or closed status by showing 'OP' = Open, or 'CL' = Closed. If the Touch V2 loses connection with an accessory, the display will show "--". A battery warning symbol will appear when an accessory reports low power. When this happens change the battery in the accessory as soon as possible.



## Removing Accessories

There are two ways to remove an accessory from the Touch V2 thermostat.

### On the Sensor/Switch

- Press and hold down the pairing/reset button for 15 seconds on the 'Sensor/Switch'. LED indicator will flash 3 times to confirm reset.

Window/Door Wireless Contact Sensor

Wireless Air Sensor

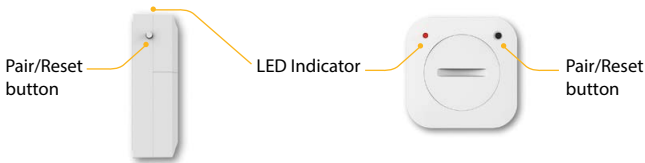

At this point the 'Sensor/Contact' will notify the Touch V2 that it has left, and will automatically be removed from the 'Accessory Menu'.

### On the Touch V2 thermostat

- Follow the steps on page 16 to enter the accessory menu.
- Press the 'Up/Down' arrow keys to view the accessory that will be deleted..... ▲ ▼
- Press and hold down the 'DONE' button for 10 seconds until the sensor disappears from the menu .....

Note: You will also need to reset the sensor at this point.



## Edit Comfort Levels



The Touch V2 offers three program mode options; Weekday/Weekend, 7 Day and 24 Hour programming. There is also the option to use the Touch V2 as a manual thermostat.

The thermostat is supplied with comfort levels already factory programmed, but these can be changed easily. The default times and temperature settings are;





07:00 - 21°C (Wake) 09:00 - 16°C (Leave) 16:00 - 21°C (Return) 22:00 - 16°C (Sleep)

Unused levels must be set to --:-- so that the Touch V2 will skip these and continue on to the next programmed time.

*For Weekday/Weekend programming, the four comfort levels are the same for Mon-Fri, but can be different for Sat-Sun. For 7 Day programming each day of the week can have four different comfort levels. In 24 Hour mode all days are programmed with the same comfort levels.*

- To program the 'Comfort Levels', press the 'EDIT' key ..... 
- Use the 'DAY' key to select day/period of week (the selection will flash) ..... 
- Press 'NEXT' to confirm selection ..... 

'WAKE' will now flash and the current time and temperature setting will be shown

- Use the 'Up/Down' key at the top to set the 'Hours' & 'Minutes' .....  
- Use the 'Up/Down' keys in the center to set the temperature .....  
- Press the 'Right' arrow key ..... 

'LEAVE' will now flash and the current settings will be displayed.

Repeat these steps above to set all comfort levels.

For any unused periods set time to --:--



- Press 'DONE' to confirm and save the settings ..... 

*You are able to program up to a maximum of 6 levels. Enable this in the feature menu.*

*Program Type = 01 (see pages 26-29).*



# Temperature Control



The 'Up/Down' keys allow you to adjust the set temperature .....  

When you press either key, you will see the words 'SET TEMP ' and the desired temperature value .....

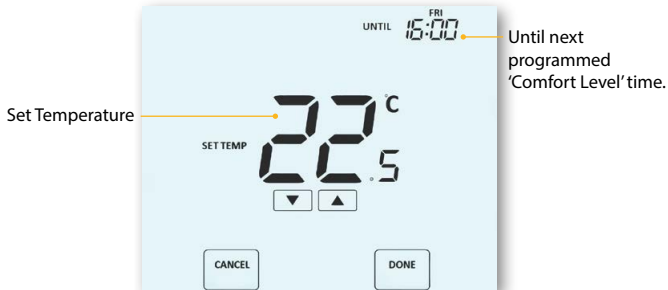
Press 'DONE' to confirm temperature setting and return to the main display... 











*Note: This new temperature override is maintained only until the next programmed comfort level. At that time, the thermostat will revert back to the programmed levels.*

Alternatively, to cancel this override, press the Up or Down key .....    
then press 'CANCEL' ..... 



# Temperature Hold



The temperature hold function allows you to manually override the current operating program and set a different temperature for a desired period.

- Press the 'Hold' key once ..... 
- Use the 'Up/Down' keys to set the desired 'Hold' time (Hours) then press 'NEXT' .....    

- Minutes will now flash.
- Use the 'Up/Down' keys to set the desired 'Hold' time (Minutes) .....  
- Use the 'Up/Down' keys to set the desired 'Hold' temperature .....  
- Press 'DONE' to confirm selection ..... 

You will see the 'HOLD LEFT' indication is displayed on screen.

The time will countdown the set duration and then revert to the normal program.

## Cancel/Edit Temperature Hold

- Press the 'Hold' key once ..... 
- Press 'CANCEL' to cancel the Hold and return to normal operation ..... 
- Alternatively, press the 'EDIT' key to adjust current 'Hold' settings ..... 

To edit 'Hold' settings follow the same procedure as indicated in the steps at the top of this page.



## Advance

This feature allows the next 'Comfort Level' setting to be brought forward and become active before its pre-programmed time.

*Note: Multiple advances aren't allowed.*

### To enable 'Advance'

- Press the 'ADVANCE' key once .....
- Press 'DONE' to confirm selection .....
- To view the 'SET' temperature during 'Advance' tap either the 'Up' or 'Down' key once ....    
Press 'DONE' to exit .....
- To change the 'SET' temperature during 'Advance', use the 'Up/Down' keys followed by 'DONE' to confirm .....



'Advanced Until' time

Level Advanced Until

### To cancel 'Advance'

- Press the 'Advance' key once, then press 'CANCEL' .....



## Frost Protection

The frost icon will toggle ON/OFF each time the  key is pressed .....

In this mode, the Touch V2 will display the frost icon and will only turn the heating 'ON' should the room temperature drop below the set frost temperature. If the heating is turned 'ON' whilst in frost mode, the flame symbol will be displayed.

To cancel the frost protect mode, press the  key again .....

Frost Protection Symbol











## Locking the Touch V2 Display

The Touch V2 has a keypad lock facility. To activate the lock follow these steps.





- Press and hold the 'HOLD' key for 3 seconds ..... 
- The display will show 0000. At this point enter a four digit pin number.
- Use the 'Up/Down' keys to set the first two digits ..... 
- Press 'NEXT' ..... 
- Use the 'Up/Down' keys to set the next two digits ..... 
- Press 'DONE' ..... 

The display will return to the main screen and display the keypad lock indicator.

*Note: The keypad lock indicator is only displayed when the lock is active.*



## Unlocking the Touch V2 Display

- To unlock the Touch V2 press any key once.....
- The display will show 0000.  
At this point enter the four digit pin number you set previously.
- Use the 'Up/Down' keys to set the first two digits ..... 
- Press 'NEXT' ..... 
- Use the 'Up/Down' keys to set the next two digits ..... 
- Press 'DONE' ..... 

The display will unlock and return to the main screen.









# Holiday

In time clock mode; the timed output will be turned off during the holiday period, then return to the programmed settings once the holiday period finishes.



In thermostat mode; the holiday function reduces the set temperature in your home to the frost mode temperature setting that is configured in the setup menu.

The Touch V2 will maintain this temperature for the duration of the holiday and will then automatically return to the program mode on your return.

## To set a 'Holiday'

- Press the 'HOLIDAY' key once ..... 
- Enter the return time (hours) by using the 'Up/Down' keys then press 'NEXT' to confirm .....   

- Enter the return time (minutes) by using the 'Up/Down' keys then press 'NEXT' to confirm .....   

- Repeat these steps to set 'Day', 'Month' & 'Year' .....
- Press 'DONE' to confirm ..... 

The display will now show  and indicate 'Frost Protection Active'

To view or change the 'Set' frost temperature while in 'Holiday' mode, press the 'Up/Down' keys followed by 'DONE' to confirm .....   



## Optional Settings Explained

**THE FOLLOWING SETTINGS ARE OPTIONAL AND IN MOST CASES NEED NOT BE ADJUSTED.**

**Viewing Accessories:** Current status of each accessory, remote sensors and window switches.

**Pairing Accessories:** to a wireless room sensor or window switch.

**Temperature Format:** This function allows you to select between °C and °F.

**Switching Differential:** This function allows you to increase the switching differential of the thermostat. The default is 1°C which means that with a set temperature of 20°C, the thermostat will switch the heating on at 19°C and off at 20°C. With a 2°C differential, the heating will switch on at 18°C and off at 20°C.

Condition: Whilst "Optimum Start" is in effect the 'Switching Differential' shall default to 1°C/F

**Output Delay:** To prevent rapid switching, an output delay can be entered. This can be set from 00 - 15 minutes. The default is 00 which means there is no delay.

Condition: Output delay will not be in effect while 'Optimum Start' is running.

**Temperature Up/Down Limit:** This function allows you to limit the use of the up and down keys. This limit is also applicable when the thermostat is locked and so allows limited control of the heating system.

**Sensor Selection:** On this thermostat, you can select which sensor should be used. You can select between air temperature only, floor temperature, or both. When you enable both sensors, the floor sensor is used as a floor limiting sensor and is designed to prevent the floor from overheating.

**Floor Temp Limit:** When the Floor Sensor has been enabled in feature 05, you can set a floor limiting temperature from 20-45°C, this protects the floor from overheating. (28°C is the default).

*Note: 'Air Sensor Only' MUST NOT be used to control electric underfloor heating. Floor Sensor or Both Air & Floor should be used.*

**Optimum Start:** Optimum start will delay enabling of the heating system to the latest possible moment avoiding unnecessary heating and ensure the building has reached its desired temperature at the programmed time. The thermostat uses the rate of change information to calculate how long the heating needs to raise the building temperature 1°C.

**Rate of Change:** Number of minutes to raise the temperature by 1°C.

*Note: The user cannot change this feature and is for information only.*

**Programming Mode:** The following program modes are available;

- Non-Programmable – Basic up/down override temperature control.
- 5/2 Day Programming – 4 levels for the weekdays and 4 different levels for the weekend.
- 7 Day Programming – 4 levels for each day.
- 24 Hours – 4 levels over a 24 hour period.

**Daylight Saving Time (DST):** is where the thermostat sets the clocks forward one hour from 'Standard Time' during the summer months, and back again in autumn, in order to make better use of natural daylight.

**Communications ID:** To interface with building management systems using the standard Modbus protocol.

**Program Type:** You can select between 4 or 6 program heating levels.





## Optional Settings - Feature Table

FEATURE	DESCRIPTION	SETTING
A	Viewing Accessory	Information only
P	Pairing Accessories	Commences countdown from 99 – 00 seconds.
01	Temperature Format	00 = °C, 01 = °F (00 = Default)
<b>Menu Entry Point</b>		
02	Switching Differential	00 = 0.5°C, 01 = 1.0°C (Default) 02 = 2.0°C, 03 = 3.0°C
03	Output Delay	00 - 15 Minutes (00 = Default)
04	Up/Down Temperature Limit	00° - 10°C (00° = Default)
05	Sensor Selection	00 = Built in Sensor with optional wireless Remote Air (Default) 01 = Wireless Remote Air Only 02 = Floor Sensor Only 03 = Built in + Floor Sensor + optional wireless Remote Air 04 = Floor Sensor + Wireless Remote Air Only
06	Floor Temperature Limit	20°C – 45°C (28°C Default)
07	Optimum Start	00 = Disabled (Default) 01 = 1 Hour 02 = 2 Hours 03 = 3 Hours 04 = 4 Hours 05 = 5 Hours
08	Rate of Change	Information Only
09	Program Mode	00 = 5/2 01 = 7 Day 02 = 24 Hour 03 = None programmable
10	(DST) Daylight Saving	00 = Disabled (Default) 01 = Enabled
11	Communications ID (Modbus)	01-32 00 = Disabled
12	Program Type	00 = 4 Comfort Levels (Default) 01 = 6 Comfort Levels



## Adjusting the Optional Settings

- Press and **hold** the  key for 3 seconds ..... 

*The display will go blank showing only  'Setup' and 'Clock'*

- Press the 'SETUP' key once, then press 'NEXT'..... 



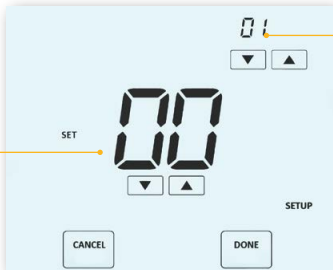



Feature No.

Feature Setting

- Use the 'Up/Down' keys at the top to scroll through features.....  

- Use the 'Up/Down' keys in the centre to change feature setting .....  

- When all required changes have been made press 'DONE' to confirm and return to the blank display ..... 

- Press the  key once ..... 



## Fail Safe

If the thermostats on board sensor is disabled and is reliant on a single wireless remote sensor for temperature measurement, failsafe will activate if connection is lost.

- From the moment 'E2' is displayed on screen, failsafe will become active.
- Approximately 12 minutes later the thermostat will enable the heat source for an initial 12 minute period and then repeat every hour.
- Failsafe will continue until the thermostat re-establishes connection to the remote sensor.



## Modbus

Modbus interface allows the thermostat to be controlled via home automation or a building management system.

- A maximum of 32 devices can be connected to a single RS485 adapter.
- It is recommended that a foil twisted pair (FTP) cable is used for the Modbus connections.
- All Modbus connections should be daisy chained rather than wired in a star formation.
- If the Touch V2 thermostat is the last Modbus device on the end of the chain, move the toggle switch on the back of the fascia to the 'On' position.

Connect the  
RS485 bus matching  
120 ohm resistor



On Connection

Off No Connection

Fascia PCB



## Recalibrating the Touch V2

This thermostat is factory set and need not re-calibrating under normal operation!

To calibrate, follow the step below.

- Press and **hold** the  key for 3 seconds ..... 

*The display will go blank showing only 'Setup' and 'Clock'.*

- Press and **hold** the  key for 10 seconds ..... 

The current temperature will appear on the display.

- Use the 'Up/Down' keys to configure the new temperature value ..... 

- Press the 'DONE' key to confirm the change and the display will go blank 

- Press the  key once to turn the thermostat 'ON' ..... 



## Error Codes

The Touch V2 will display an error code if there is a fault with the temperature sensor, these error codes are explained below.

E0 = The internal sensor has developed a fault.

E1 = The remote FLOOR probe has not been connected.

The remote FLOOR probe has not been wired correctly.

The remote FLOOR probe is faulty.

E2 = The WIRELESS AIR SENSOR has not been paired correctly.

The WIRELESS AIR SENSOR has lost connection to the Touch V2.

(check batteries).

The remote WIRELESS AIR SENSOR is faulty.





## Wiring Diagram - Touch V2 Switch Live Output

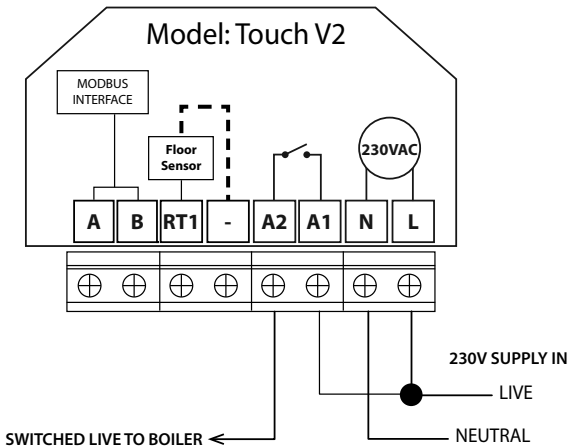

This product must only be installed by a qualified electrician and comply with local installation regulations.



## Wiring Diagram - Touch V2 Volt Free Output Thermostat & Time Clock Modes

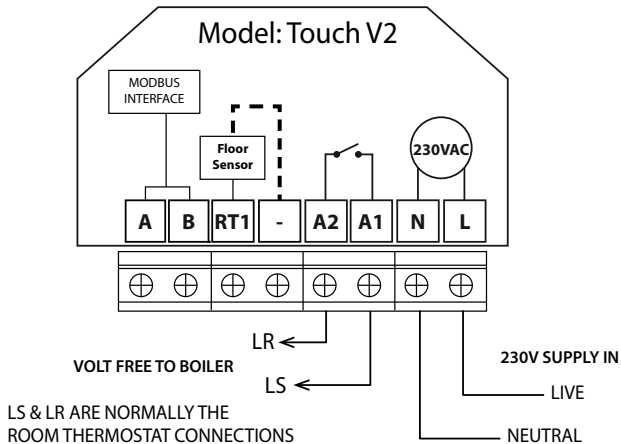

This product must only be installed by a qualified electrician and comply with local installation regulations.



## Wiring Diagram - Touch V2 to Valve

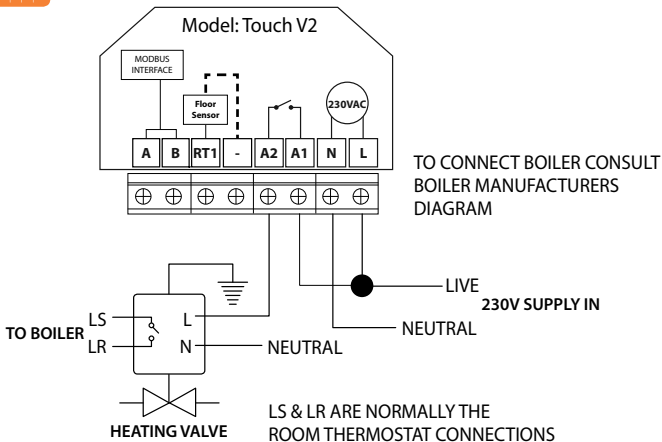

This product must only be installed by a qualified electrician and comply with local installation regulations.



## Wiring Diagram - Touch V2 Switch Live to UH8

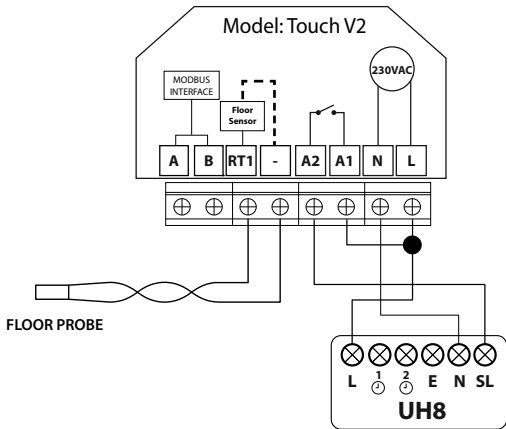

This product must only be installed by a qualified electrician and comply with local installation regulations.

# 2

## Mode 2 - Time Clock

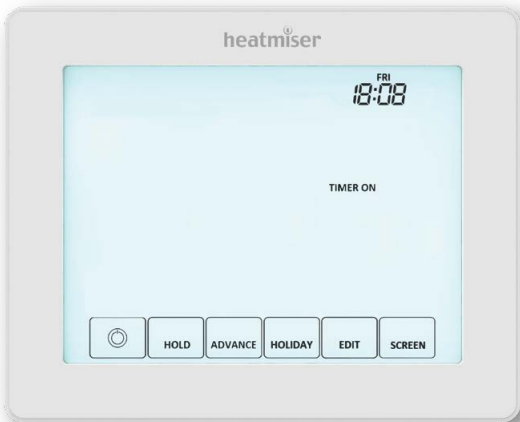

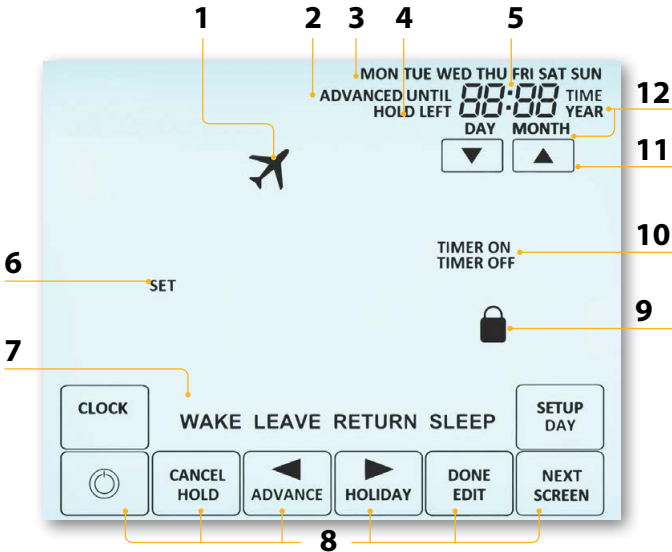

1. Holiday – Displayed when the time clock is in holiday mode.
2. Advanced Until - Displayed when the time clock is advanced to the next programmed comfort level.
3. Day Indicator – Displays the day of the week.
4. Hold Left – Displayed when a timer hold is active, the remaining time will be shown.
5. Clock – Time displayed in 24 hour format.
6. Set – Indicated when changes are being made to the current set point.
7. Program Indicator – Displayed during programming, to show which level is being altered.
8. Navigation/Programming keys – Used to configure the Touch V2.
9. Keypad Lock Indicator – Displayed when the keypad is locked.
10. Timer On/Off – Indicates state of time clock output.
11. Up/down keys – Increase/decrease of higher digit group.
12. Time/Day/Month/Year – Displays when setting the Clock/Calendar or a Holiday Period.



## Setting the Switching Times

- To program the 'Switching times', press the 'EDIT' key
- Use the 'DAY' key to select day/period of week (the selection will flash)
  - Press 'NEXT' to confirm selection   
     'WAKE' will now flash and the ON time will be displayed .....
  - Use the 'Up/Down' key at the top to set the 'Hours' & 'Minutes'
  - Press Next   
     The OFF time will now be displayed .....
  - Use the 'Up/Down' key at the top to set the 'Hours' & 'Minutes'
  - Press the right arrow key   
     'Leave' will now flash and the ON time will be displayed .....
  - Repeat the steps above to set all switching time levels.....
  - For any unused periods set time to --:-- .....
  - Press 'DONE' to confirm and save the settings





## Timer Advance

This feature allows the next 'Switching time level' setting to be brought forward and become active before its pre-programmed time. Note: Multiple advances aren't allowed.

### To enable 'Advance'

- Press the 'ADVANCE' key once .....   
The 'ADVANCED UNTIL' time and the output status will now be displayed.
- Press 'DONE' to confirm .....

### To cancel 'Advance'



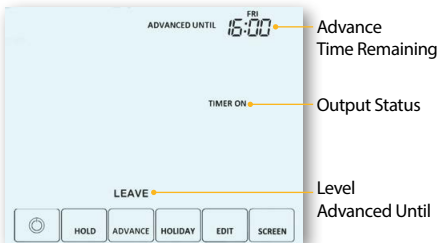

- Press the 'Advance' key once, then press 'CANCEL' .....   
.....











## Timer Override

To override the timed output 'ON/OFF', follow these steps.

- Press the 'Hold' key once ..... 
- Use the 'Up/Down' keys to set the desired 'Hold' time (Hours) then press 'NEXT' ...   

Minutes will now flash.

- Use the 'Up/Down' keys to set the desired 'Hold' time (Minutes) .....  
- Use the 'Up/Down' keys in the center to adjust the output state .....  
- Press 'DONE' to confirm selection ..... 

You will see the 'HOLD LEFT' indication is displayed on screen. .... 

The time will countdown the set duration and then revert to the normal program.

### To cancel Timer Override

- Press 'HOLD' then press 'CANCEL' ..... 



## Optional Settings Explained

**Programming Mode:** The following program modes are available;

**5/2 Day Programming** - 4 On/Off switching times for the weekdays and 4 On/Off switching times for the weekend.

**7 Day Programming** - 4 individual On/Off switching times for each day.

**24 Hours** - 4 On/Off switching times over a 24 hour period.

**Daylight Saving Time (DST):** is where the thermostat sets the clocks forward one hour from Standard Time during the summer months, and back again in autumn, in order to make better use of natural daylight.

**Communications ID:** To interface with building management systems using the standard Modbus protocol.







## Optional Settings - Feature Table







FEATURE	SETTING
Program Mode	00 = 5/2 (Default), 01 = 7 Day, 02 = 24 Hour
Daylight Saving Time (DST)	00 = Disabled (Default) 01 = Enabled
Communications ID	01-32 (00 = Disabled)

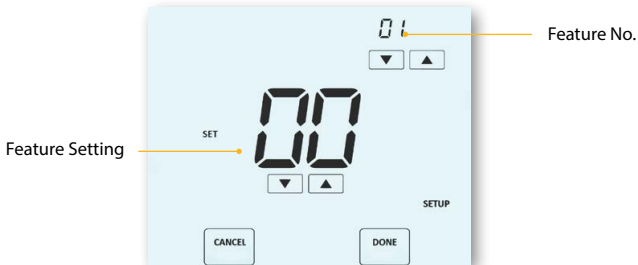

## Adjusting the Optional Settings

- Press and **hold** the  key for 3 seconds .....   
*The display will go blank showing only  'Setup' and 'Clock'*
- Press the 'SETUP' key once ..... 



- Use the 'Up/Down' keys at the top to scroll through features .....  
- Use the 'Up/Down' keys in the centre to change feature setting .....  
- When all required changes have been made press 'DONE' to confirm and return to the blank display ..... 
- Press the  key once ..... 



## Replacing the Battery

In most cases the 3 volt lithium battery does not need replacing if the thermostat has a continual power supply. Its sole purpose is to ensure correct time keeping during a power loss to the thermostat.

To remove the battery use a small flat head screw driver or fingertip to push back the brass retaining bracket. This will automatically release the battery.

Insert the new battery (**positive side up!**) by locating one end underneath the **holding clips** then pushing down on the opposite end against the brass holding bracket.

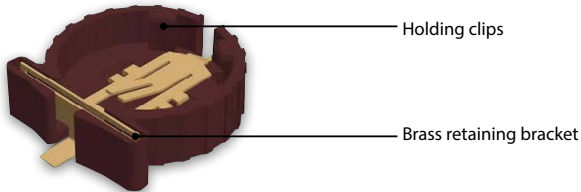

We advise that replacement of the lithium battery be carried out by a qualified professional.



## Notes

A series of horizontal dotted lines for writing notes, spanning the width of the page.



## Notes

A series of 18 horizontal dotted lines for writing notes.



## Want More Information?

Call our support team on: +44 (0)1254 669090

Or view technical specifications directly on our website:  
[www.heatmiser.com](http://www.heatmiser.com)



PDF



FAQ



Twitter: @heatmiseruk



Facebook: [facebook.com/thermostats](https://facebook.com/thermostats)