

# Galapagos

ELECTRIC THERMOFLUID RADIATOR



All electrical appliances produced for the Company are guaranteed for one year against faulty material or workmanship. This applies only if the appliance has been used for purposes in accordance with the instructions provided and has not been connected to an unsuitable electricity supply, or subject to misuse, neglect, damage or modified or repaired by any person not authorised by the Company. This guarantee is offered to you as an extra benefit and does not affect your legal rights. The correct electricity supply voltage is shown on the rating label attached to the appliance. Reasonable care has been taken to ensure that this guide is accurate at the time of printing. In the interest of progress the Company reserve the right to vary specifications from time to time without notice.



- **Caution very hot surface.**

**CAUTION:**

**Some parts of this product can become very hot and cause burns. Particular attention is required when children and dependent individuals are present.**

Caution: Very hot surface.

- Children under 3 must be kept away from this appliance, unless they are under constant supervision.
- Children between the ages of 3 and 8 must only turn the appliance on or off provided that the appliance has been positioned or installed in a normal intended position and provided that the children are supervised or have been instructed with respect to the safe use of the appliance and that they fully understand the potential dangers. Children between the ages of 3 and 8 must not connect, adjust or clean the appliance or perform any product maintenance.
- This appliance can be used by children who are at least 8 years old and by persons with limited physical, sensory or mental abilities or without any experience or knowledge of the appliance if they are properly supervised or if they have been given instructions with respect to the safe use of the appliance and if the potential risks have been understood. Children must not play with the appliance. Cleaning and maintenance of the appliance by the user must not be performed by children without supervision.
- This appliance must only be wired or connected by qualified personnel, in accordance with applicable regulations and standards.
- If the power supply cable is damaged, it must be replaced by the manufacturer, their after-sales department or by a similarly qualified individual for safety reasons.
- The operating manual for this appliance is available from the manufacturer's website (the internet address is provided on the warranty certificate included in this manual).
- When the appliance is initially heated, a slight odour may be perceived, this is related to the removal of any traces resulting from the appliance's manufacturing process.
- A system for managing energy or for power cut-off by interrupting the power supply is incompatible with our appliances since it damages the thermostat.
- The radiator is filled with a heat transfer fluid that is detrimental to health if ingested. In the event of a leak, contact a professional and take any precautionary measures to prevent users, particularly young children and dependent individuals, from ingesting the fluid.

	<p><b>Warning:</b> to prevent overheating and for safety reasons, do not cover the heating appliance.</p>
	<p>Appliances with this symbol must not be disposed of in household waste but must be collected separately and recycled. The collection and recycling of end-of-life products must be carried out according to local provisions and orders.</p>



Installing an appliance at altitude increases the air outlet temperature (by approximately 10°C per 1,000 m of elevation).

Installing vertical appliances above an altitude of 1,000 m is not recommended (*risk of faulty operation*). Installing a vertical appliance horizontally, and vice versa, is prohibited. Using the appliance in a mobile configuration, on feet or on rollers, is prohibited.

### Your appliance's references

These are located on the left-hand side of the appliance.

The commercial Code and the serial Number will inform the manufacturer of the type of appliance that you have acquired. Enter the commercial code and the serial number in the warranty section at the back of this manual.

<p>A Standards, quality labels B Brand name C Commercial code D Manufacturer's reference E Serial No. F Manufacturer's No.</p>	<p>A Standards, quality labels B Brand name <b>C Commercial code</b> D Manufacturer's reference <b>E Serial No.</b> F Manufacturer's No.</p>
--	--

**Declaration of conformity**  
DIRECTIVE RED 2014/53/EU(\*)

---

Atlantic Industrie hereby declares that the equipment referred to hereafter is compliant with the essential requirements of directive RED 2014/53/EU.

<b>Designation:</b>	Radiator with i2g radio card
<b>Models:</b>	Refer to the model references in the manual's header
<b>Features:</b>	
<b>Radio frequency:</b>	868 MHz Transceiver
<b>Class 2 radio equipment:</b> can be marketed and commissioned without any restrictions.	
<b>Radio range:</b> from 100 to 300 metres in free-field conditions, varying according to the auxiliary equipment (the range can be altered depending on the installation conditions and the electromagnetic environment).	
<b>Conformity with radio standards and electromagnetic compatibility has been verified by notified body 0081: LCIE France, Fontenay aux Roses.</b>	

## Installation

Despite all the care taken during the various manufacturing steps, when unpacking the appliance traces of oil are sometimes present on the cardboard box or on the product. These traces result from the radiator's manufacturing process and by no means prevent it from operating correctly. Simply wipe the traces of oil with absorbent paper.

### PREPARING FOR INSTALLATION OF THE APPLIANCE

#### Installation guidelines

- This appliance has been designed to be installed in a residential room. Please consult your distributor in all other cases.
- The installation must be carried out implementing best practices and in accordance with the current standards in the country of installation (*NFC 15-100 for France*).
- The appliance must be supplied with 230 V single-phase, 50 Hz.
- In humid rooms, such as bathrooms and kitchens, the junction box must be installed at least 25 cm from the ground.

**Keep the appliance away from an air current that is likely to interfere with its operation** (e.g.: under a Centralised Mechanical Ventilation system, etc.).

**Do not install the appliance under a fixed electric socket.**

	<b>Volume 1</b>	No electrical appliance
	<b>Volume 2</b>	Class II - IP X4 electrical appliance
	<p>To optimise your appliance's presence detection, do not install it at a tight angle or behind a piece of furniture.</p>	
<p>Observe the minimum distances from furniture when locating the appliance.</p>	Horizontal and Low height	

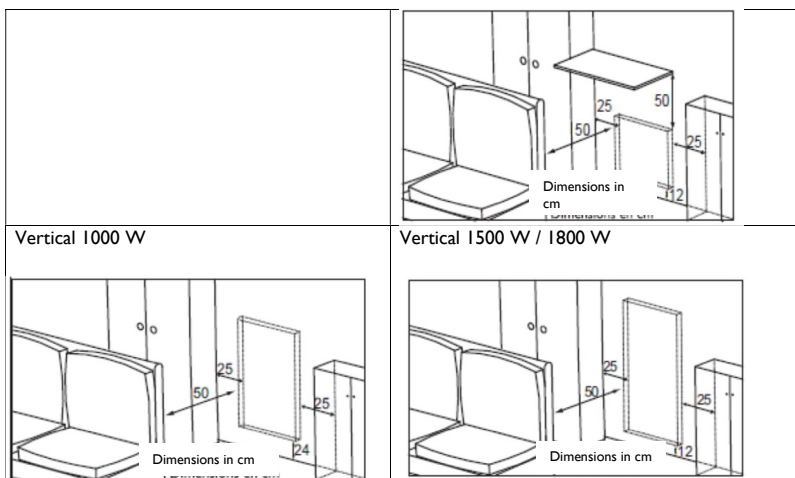

**CHANGING THE POSITION OF THE CONTROL UNIT - VERTICAL Model**

The radiator's control unit is located on the right-hand side by default (*with the appliance wall mounted*).

**On the VERTICAL model, the unit can be placed on the left-hand side.**

To this end, perform the following operations:

- Operations to be performed with the power off, with the radiator lying flat, face downwards and in its 2 protective wedges.



Use the Allen key supplied with the radiator.

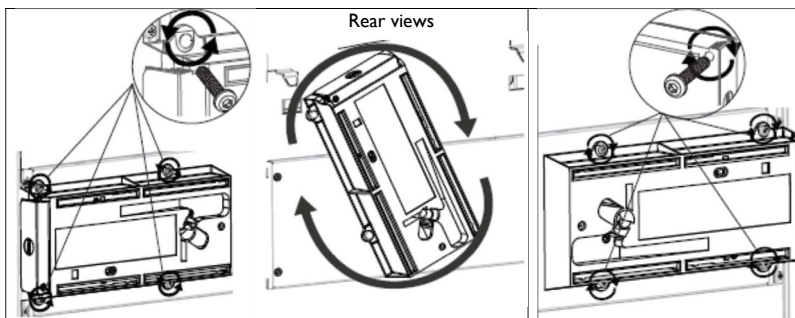

1) Remove and retain the 4 mounting screws located behind the control unit bracket.

2) Pivot the unit's bracket by a half-turn upwards and to the right.

3) Mount the unit's bracket using the 4 screws.

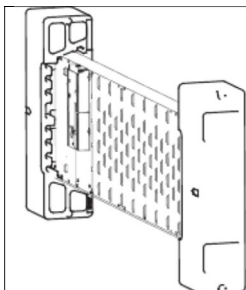

4) Place the radiator in its 2 wedges, on the side opposite the unit.



5) Press the side of the unit to remove it from the bracket.

Front views

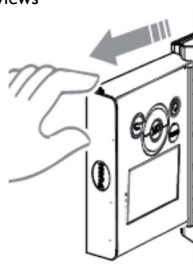

6) Pull the side of the unit so that it is fully visible.

7) Remove and retain the two mounting screws in the rear section of the control unit.

Rear views

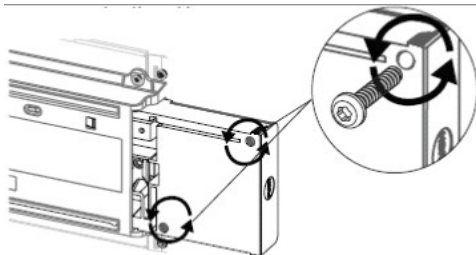

8) Gently pull the front section of the control unit to disconnect it.

Front views

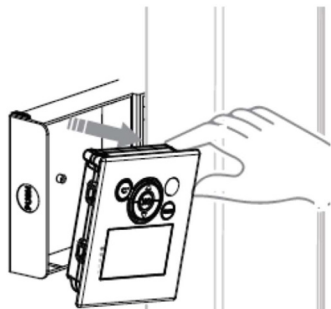

9) Pivot the front section by a half-turn to position the screen at the top.



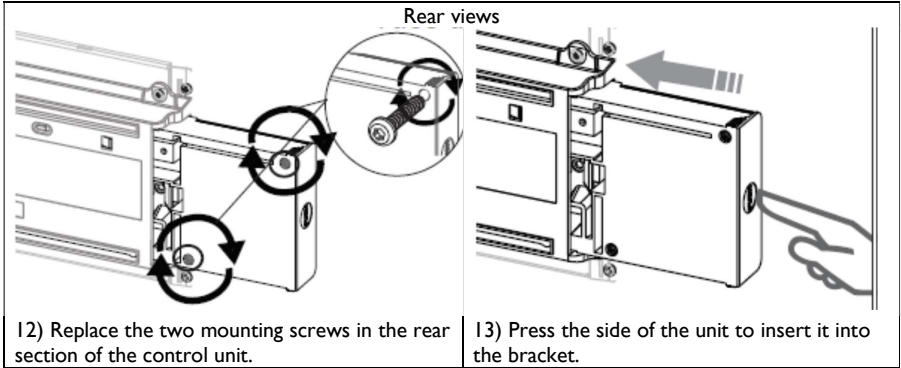
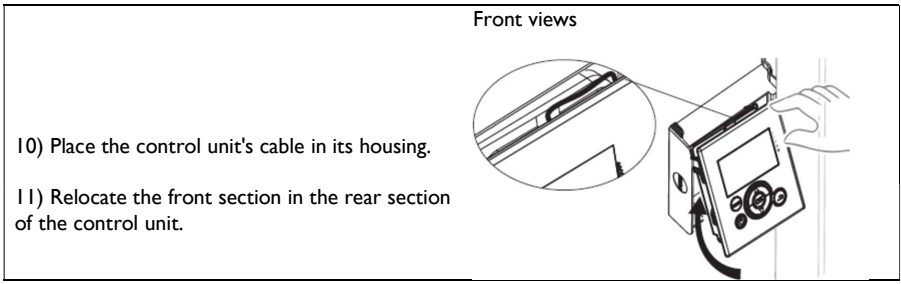

**MOUNTING THE WALL BRACKETS - VERTICAL Model**

Procure wall plugs and screws that are adapted to your type of wall and are able to support at least 40 kg per mounting point (*the screws and wall plugs are not supplied*).

- 1) Use the mounting template.
- 2) Find the middle of the radiator using the dashed line.
- 3) Find the 4 drilling points for mounting the radiator and mark them with a pencil.

Power	A	B
1000 W	1025	383
1500 W	1325	263
1800 W	1535	263

- 4) Drill the 4 mounting holes for the radiator and insert the wall plugs.
- 5) Insert the screws into the wall plugs (*leave the screws protruding by 6 mm maximum*).

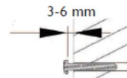

- 6) Position the brackets by passing the screw heads through the slots.
- 7) Before commencing screwing, align the **lower** wall bracket marks with the 2 screws.

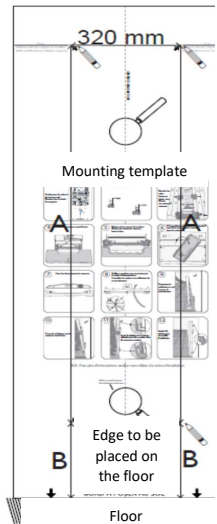



8) Ensure that the brackets are level.

9) Screw in the brackets.

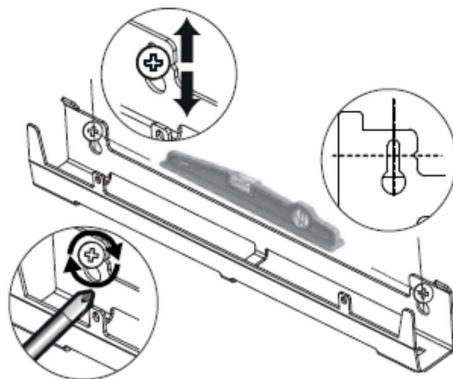

### MOUNTING THE WALL BRACKET HORIZONTAL and LOW HEIGHT Models

 Procure wall plugs and screws that are adapted to your type of wall and are able to support at least 40 kg per mounting point (*the screws and wall plugs are not supplied*).

1) Place the bracket on the ground and against the wall.



2) Mark the drilling points **A**.

The drilling points **A** give the position for the lower mounts.

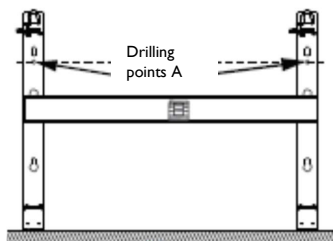

Low height

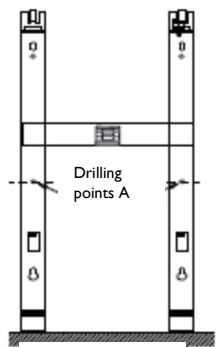

Horizontal

3) Remount the wall bracket, aligning it with the drilling points **A**, in order to mark the drilling points **B**.

The drilling points **B** give the position for the upper mounts.

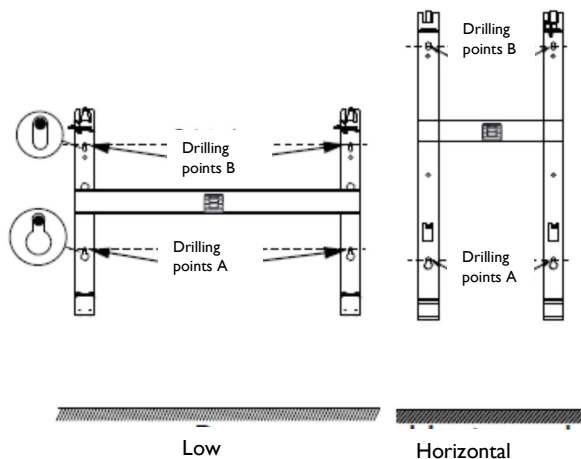

4) Drill the 4 holes and insert the wall plugs. Use wall plugs that are adapted to your type of wall.

5) Position and screw on the wall bracket.

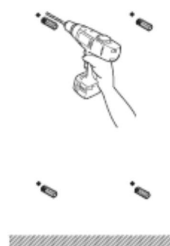

## CONNECTING THE APPLIANCE



### VERTICAL Model

If the electrical junction box is located above the lower wall bracket, then connect by passing the power supply cable through the bracket. This avoids pinching the cable.

### Horizontal and Low height Models

If the cable is too long, use the cable grommet located on the wall bracket.

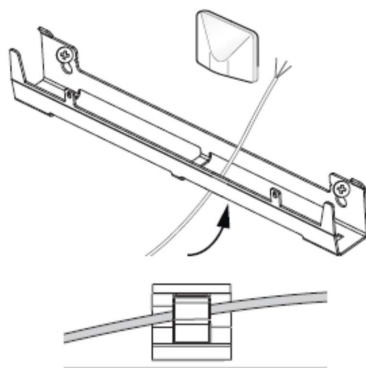

### Connection guidelines

- The appliance must be supplied with 230 V single-phase, 50 Hz.

- The appliance's power supply must be directly connected to the network downstream of the circuit-breaker and without an intermediate switch.
- The appliance's cable is used to connect to the supply circuit through a junction box. In humid rooms, such as bathrooms and kitchens, the junction box must be installed at least 25 cm from the ground.
- **Connection to ground is prohibited.**  
**Do not connect the pilot wire (black wire) to ground.**
- The power supply must be connected to the network downstream of the omnipolar cut-off device in accordance with the installation guidelines.
- If the power supply cable is damaged, it must be replaced by the manufacturer, their after-sales department or by a similarly qualified individual for safety reasons.
- If the pilot wire (*black wire*) is used and it is protected by a 30 mA differential (for example: in the bathroom), the power supply for the pilot wire on this differential needs to be protected.
- If you intend to use a cut-off device, select a cut-off device with a pilot wire or radiofrequency or carrier current output. Do not use a cut-off device with power supply circuit interruption, to avoid damaging the thermostat.

### Appliance wiring diagram

- Turn off the electrical power supply and connect the wires as follows:

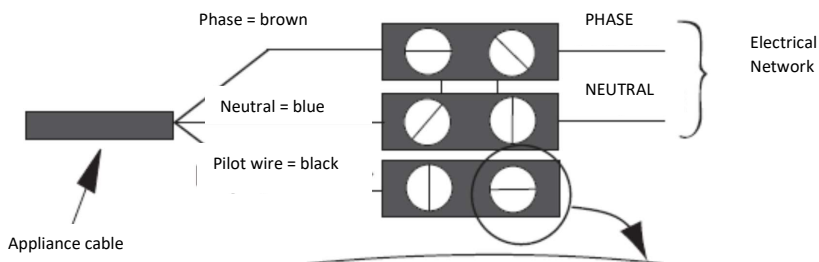

Two possible cases

1st case: Single appliance



Appliance not controlled.  
The pilot wire is not connected.

2nd case: Slave appliance



To appliance with a programming cassette or unit.

- You can connect the pilot wire if your house is fitted with a programming unit, a programmer or an energy management system.

In this case, to check for correct transmission of the programming instructions, complete the following checks as per the selected modes (*Comfort, Eco, etc.*):

	COMFORT	ECO	FROST PROTECTION	SHUTDOWN OF HEATING - POWER CUT-OFF	COMFORT -1°C	COMFORT -2°C
SIGNAL TO BE TRANSMITTED						
MEASUREMENT BETWEEN THE PILOT WIRE AND NEUTRAL	0 Volt	230 Volt	-115 Volt negative	+115 Volt positive	230 Volt for 3 sec	230 Volt for 7 sec

## MOUNTING AND LOCKING THE APPLIANCE ON THE WALL BRACKETS - VERTICAL Model

- 1) Place the radiator on the ground in front of the wall brackets.
- 2) Lift the radiator in order to place the lower hooks of the radiator on the lower wall bracket.
- 3) Move the top of the radiator towards the upper wall bracket until they make contact.
- 4) Gently lift the radiator, keeping it properly aligned.
- 5) Move the top of the radiator towards the wall.
- 6) Gently lower the radiator.
- 7) Place the upper hooks onto the upper wall bracket and the lower hooks onto the lower wall bracket.
- 8) Lock the radiator onto the brackets by clipping-in the 4 plastic covers to ensure that the appliance is properly mounted.

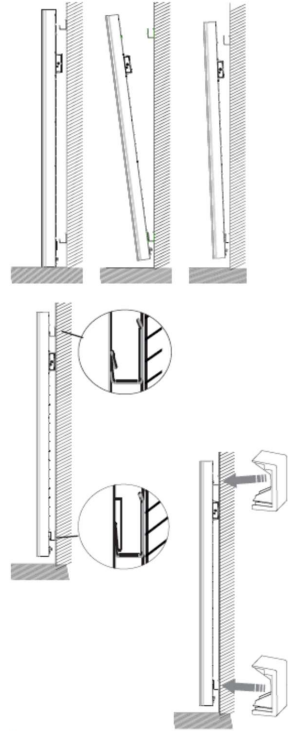

3

## MOUNTING AND LOCKING THE APPLIANCE ON THE WALL BRACKET HORIZONTAL and LOW HEIGHT Models

- 1) Place the radiator on the lower part of the wall bracket.
- 2) Move the radiator towards the upper part of the bracket then lift and introduce the bracket into the holes on the radiator.
- 3) Turn the lock using a screwdriver.

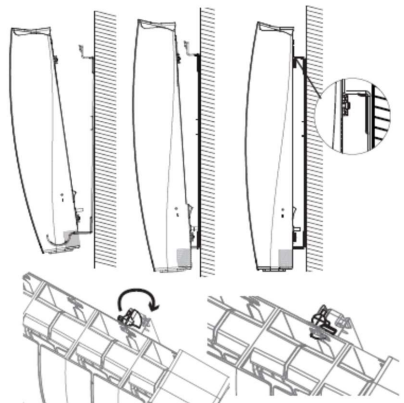

## MAINTENANCE

Turn off the electrical power supply to the radiator before performing any maintenance work.

To maintain the radiator's performance, dust removal is required approximately 2 times per year.

### Never use abrasive products and solvents.

This radiator is filled with an exact amount of heat transfer fluid. This fluid is invariable and does not require any particular maintenance. Repairs that involve opening the fluid reservoir must only be performed by a professional, the manufacturer or their after-sales department.

The after-sales department must be contacted in the event of a leak.

When the appliance is discarded, the fluid must be disposed of at a waste fluid disposal site.

## Description

### THE CONTROL UNIT

(Screen for horizontal and vertical models)

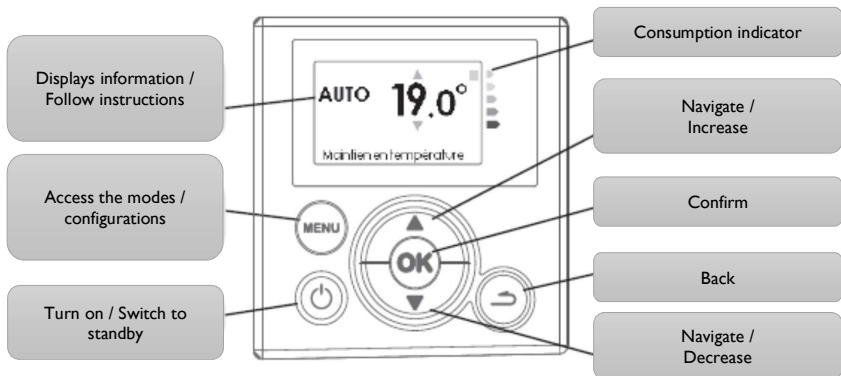

### Turning on / Switching to standby



To turn on the appliance, press .

The green ring around the  key lights up.

To switch the appliance to standby, press and hold .

The green ring around the  key turns off.

### Locking / Unlocking the commands

The control unit can be locked to prevent it from being unintentionally handled. To lock the control unit, press + together for 5 seconds.

Perform the same operation to unlock the control unit.

## THE SWITCH

An On/Off switch is located behind the appliance. Only use this switch for an extended shut-down period (*outside the heating periods*).



After an extended shutdown period, the day and the time may need to be reset.





## INITIAL START-UP



Check that the switch is set to I (*on*).

On initial power-up, follow the instructions displayed on the screen.

### Setting the language

Change the language using  and confirm using . The language setting can be re-accessed using the Expert Menu (*refer to the "Expert Menu" chapter*).

### Setting the date and time

Set the day using  and confirm using . Perform the same operation to set the month, year, hour and minutes.

The date and time setting can be re-accessed.



By default, the unit automatically switches to summer/winter time. Automatically switching to summer/winter time can be deactivated (*refer to the "Expert Menu" chapter*).

### Appliance status

By default, on initial power-up, the appliance is set as follows:

Per Model

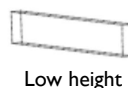
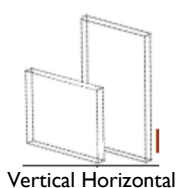



Operating mode	AUTO	PROG
Setpoint temperature	19°	19°
Open window detection	Active	Active
Presence detection	Active	Not available
Temperature reduction	-3°C	-3.5°C

## CONNECTIVITIES

Before performing any action, illuminate the screen by pressing any key.

With our heating appliances that integrate **iO-homecontrol®**  you can perform the following tasks through the Connectivities menu:

- **Pair** several  compatible appliances in the same room.  
 For optimum operation, only appliances located in the same room should be paired (*up to a maximum of 5 appliances*).
- **Connect** your appliances to the Cozytouch app to remotely control the appliances (*from the app*).

### Accessing CONNECTIVITIES:



### Pairing appliances

 appliances that are located in the same room can be paired so that they can communicate and share information.

For example, when several appliances are paired, a change in the temperature or in a mode on one appliance is immediately fed back to all the other appliances.

### Accessing PAIRING:



For example: pairing 3 appliances in the same room:



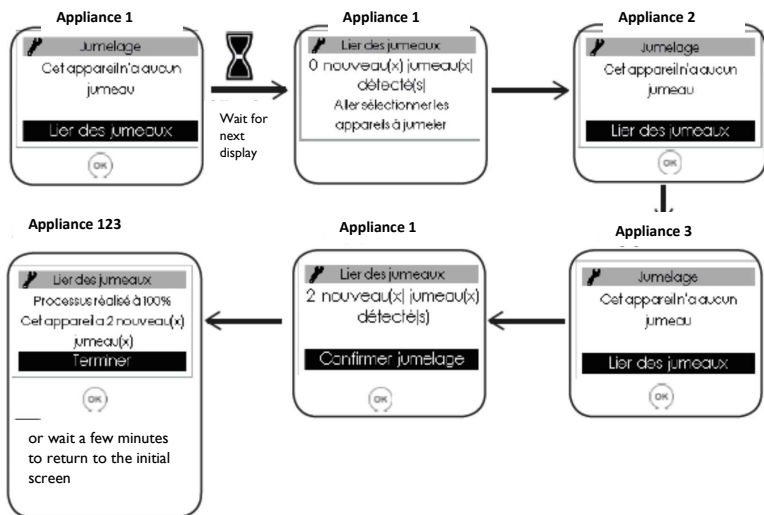

### **Display the paired appliances:**

You can view the appliances that you have paired.



### **Delete pairing:**

 This operation deletes all the connections between the appliances.



### **Add a pair:**

The existing pairing must be deleted (refer to “Delete pairing”) and the operation must be restarted to pair all the appliances.

## **Connection**

This appliance is compatible with our Cozytouch product and with units using the iO-homecontrol®  protocol.

Required accessories:

- iOS and Android compatible Cozytouch App. Available as a free download from the App Store® or from the Google Store®.
- Cozytouch Bridge  
Sold by our brand distributors.
- Internet access unit.



This installation allows you to remotely control, program and check your  appliance(s) using a smartphone or a tablet.

For example, you can change the setpoint temperature or the operating mode, manage your periods of absence by indicating your return date or view the consumption of your appliances. You can connect to the app, to an appliance or to a set of appliances that you have paired.



**Perform all the connection or control operations from the app** (follow the instructions displayed on your smartphone or on your tablet).

### **Connect your appliances:**

Follow the instructions provided in the app.



If the appliances are already paired, then perform this operation on one appliance only.

## **ADJUSTING THE TEMPERATURE**

Before performing any action, illuminate the screen by pressing any key.

### **Setpoint temperature**

To change the setpoint temperature, use .

By default, the setpoint temperature is set to 19°C (*recommended temperature*) and is adjustable from 12°C to 28°C.

To change the Comfort setpoint temperature when the appliance is in PROG mode, the temperature first needs to be changed in BASIC mode, then return to PROG mode.

Use the consumption indicator to optimise your adjustment. When the consumption indicator is level with the green symbol, your temperature level is below or equal to the recommended temperature.



A period of at least 6 hours needs to elapse for the temperature to stabilise.

## Frost Protection position

Use this function when you are absent for more than 48 hours.



Irrespective of the selected mode, to activate Frost Protection press ▼ until 7.0° is displayed.

When you return, reset the setpoint temperature to return to normal operation.

## OPERATING MODES

Before performing any action, illuminate the screen by pressing any key.

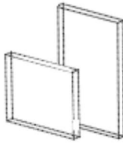
Select the operating mode best suited to your requirements.

2 or 3 operating modes are proposed depending on the models	Vertical Horizontal Models 	Low height Model 
<b>AUTO</b>	Use of smart control. The appliance programs itself.	Mode not available
<b>BASIC</b>	Access to the temperature adjustment and to the connectivity functions only.	
<b>PROG</b>	Manual programming of functions (use of the internal or external programming).	

### Access the MODES:

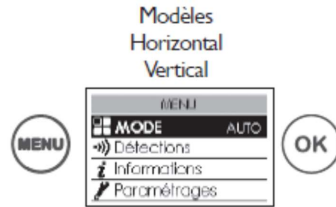
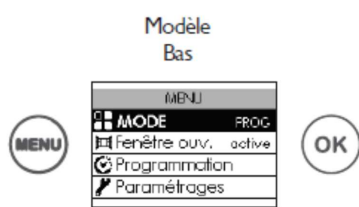
<p>Modèles Horizontal Vertical</p> 	<p>Modèle Bas</p> 
--	--

## AUTO MODE

Not available on the low height model.

This mode allows smart control to be activated. You adjust the desired temperature when you are present in the room and the appliance optimises your comfort whilst implementing savings.



The appliance:

- records your weekly lifestyle and any changes to your lifestyle in order to implement its own programming;
- anticipates heating so that the room is at the correct temperature upon your return;
- detects any unforeseen periods of presence and absence in order to automatically adjust the temperature;
- detects any opening and closing of windows in order to lower the temperature to 7°C when you air the room.

### **Functions accessible in AUTO mode**

- **Temperature reduction**



Allows the maximum reduction level to be adjusted for the temperature that you desire during your periods of absence (from -2°C to -4°C). By default it is set to -3°C.

- **Detection functions**

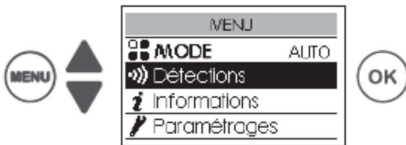

The presence detection function is always active.

By default, the open window detection function is active and can be deactivated (refer to the "Detection functions" chapter).

- **Displaying smart control information**

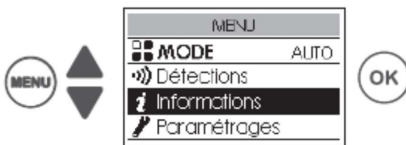

### **Autoprogrammation (Self-programming)**

Allows periods of presence to be displayed that have been observed by the appliance for each day of the week. Your appliance continuously learns, stores and assesses your lifestyle in order to adapt the temperature of your room.



Following the initial start-up, one week of operation is required in order to define self-programming. It is then refined and evolves over time. During this learning week, the appliance will not automatically lower the temperature.

## Temps d'anticipation (Anticipation time)

To optimally anticipate heating up before you return, your appliance learns and stores the heating-up time according to the characteristics of your room (*volume, insulation, outside temperature, etc.*).

## Économies d'énergie (Energy savings)

Your appliance notifies you of any savings that have been made by showing the amount of time it has taken to reduce the temperature over the past 7 days.

 Following the initial start-up, one week of operation is required in order to see an initial result. It will then be continuously updated.

## BASIC MODE

The appliance continuously adheres to the adjusted setpoint temperature. All the smart functions are deactivated.



## PROG MODE

In PROG mode, the appliance adheres to:

- either the internal program defined for each day of the week;
- or the instructions from the external programming system for your installation.

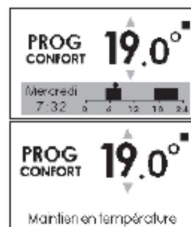

## To define the programming source:



- **Internal programming**  

This programming source is selected by default. The appliance follows the defined programs. Programs are pre-recorded. You can change the programs (*refer to "Change the internal programs"*).



To control the appliance from the Cozytouch app, select the internal program.



**External programming**

The appliance adheres to the instructions from the external programming system for your installation through a pilot wire link or an radio link.

To control the appliance through an radio link, it must be connected to the energy management system (refer to "Connect the appliance with one of our brand's external radio energy management systems").

**Changing the internal programs:**



In internal programming, you can program up to 3 Comfort temperature periods for each day of the week. Outside these periods, the appliance lowers the temperature (set to -3.5°C by default).

Change the periods using and confirm using .

To delete a comfort period, change the start and end times until they are the same.

Examples of programs:

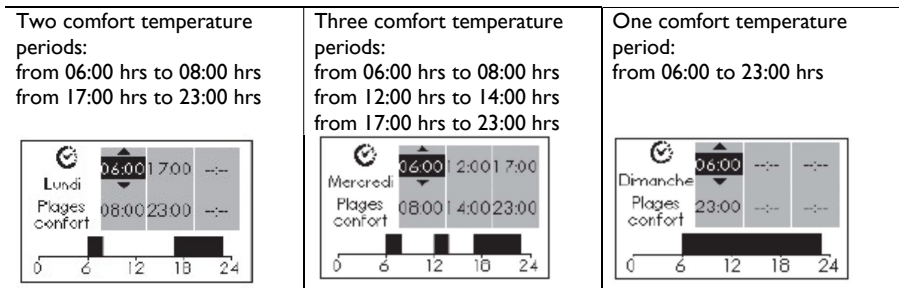

**Copying a program**

You can copy the program that is defined for one day to one (or more) other day(s).

Scroll through the days using . Copy using . Return to the previous day using .

For example: copy the program from Monday to Thursday.

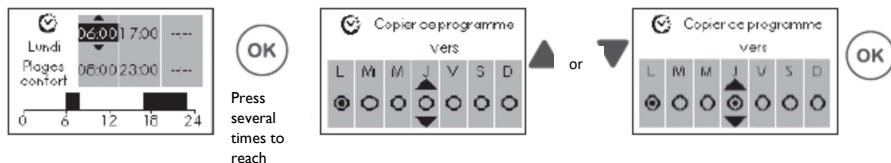

### **Connecting the appliance with one of our brand's <sup>TD</sup> external radio energy management systems:**

- 1) If the appliances are paired, delete the pairing of the appliances (refer to the "Connectivities" paragraph).
- 2) Send the security key from the energy management system (refer to the energy management system manual).
- 3) Receive the security key on the appliance(s) (refer to the "Expert Menu" chapter).

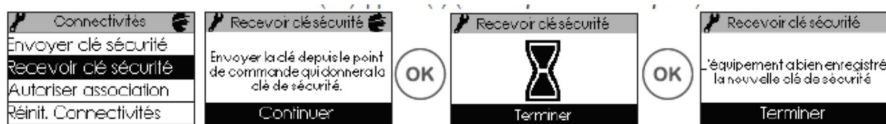

- 4) Add a heating point to the desired zone from the energy management system (refer to the energy management system manual).
- 5) Authorise the connection to the appliance(s) (refer to the "Expert Menu" chapter).



### **Functions accessible in PROG MODE:**

- **Temperature reduction**



Allows the reduction level to be adjusted for the temperature that you desire outside the Comfort periods (from -2°C to -9°C). By default, it is set to -3.5°C (if the setpoint temperature is set to 19°C, then, outside the Comfort periods, it will reduce to 15.5°C).

- **Detection functions**

(The presence detection function is available on the horizontal and vertical models. The open window detection function is available on all models).

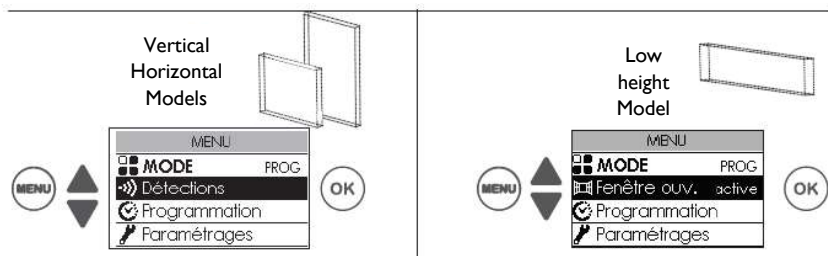

By default, the presence detection function is inactive and the open window function is active (refer to the "DETECTION FUNCTIONS" chapter).



Activating the presence detection function in Prog Mode allows any unforeseen presence to be detected automatically.

For example: for Monday you programmed a Comfort period from 17:00 hrs to 23:00 hrs. You return at 15:00 hrs. The appliance detects your presence and automatically switches to the Comfort period.

- **One-off bypassing of the programming**

Presence detection function inactive

Allows any unforeseen presence to be managed.

For example: for Monday you programmed a Comfort temperature period from 17:00 hrs to 23:00 hrs. You return at 15:00 hrs and the appliance displays an Eco temperature. You can manually increase the temperature.



One-off bypassing is active up until the next Comfort temperature period that is defined in the program. The appliance then reverts to its normal operation.



The Comfort temperature setpoint is changed in BASIC mode.

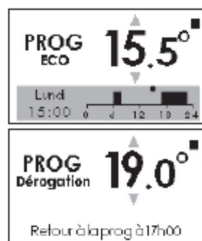



## DETECTION FUNCTIONS

Before performing any action, illuminate the screen by pressing any key.

Enables detection of temperature variations associated with opening and closing your windows. If you forget to turn off your appliance while a window is open for a long period, then this function overcomes this problem and avoids unnecessarily heating your appliance.

The appliance automatically switches to Frost Protection mode (7°C) when it detects an open window and returns to the setpoint temperature when it detects its closure (*the detection time varies*). The appliance reacts to the opening and closing of windows according to several variables, which particularly include:

- the desired temperature in the room;
- the outside temperature;
- the configuration of the installation.

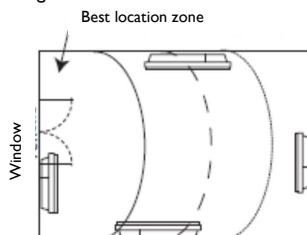

The use of this function is not recommended in corridors and in rooms located in the vicinity of an entrance door opening onto the outside.

### Activating/Deactivating the function

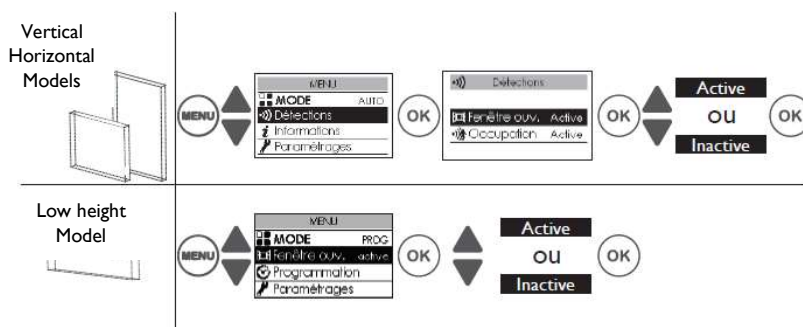

If the appliances are paired, you can deactivate the open window detection of a single appliance without deactivating the others (*refer to the "Configurations" chapter in the "Expert Menu"*).

### Presence

Not available on the low height model.

Allows your room to be heated only when someone is present. The appliance applies the recorded setpoint temperature. Detection is not possible underneath the sensor and is not possible if there is not enough light.

## Activating/Deactivating the function



Function always active in AUTO MODE

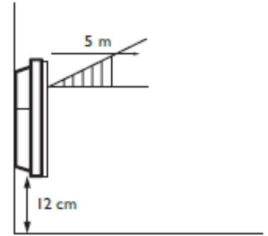
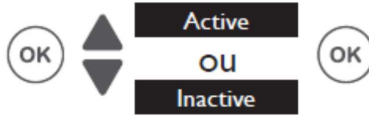

For example: your appliance is set to 19°C in Comfort mode (whether or not it is programmed).

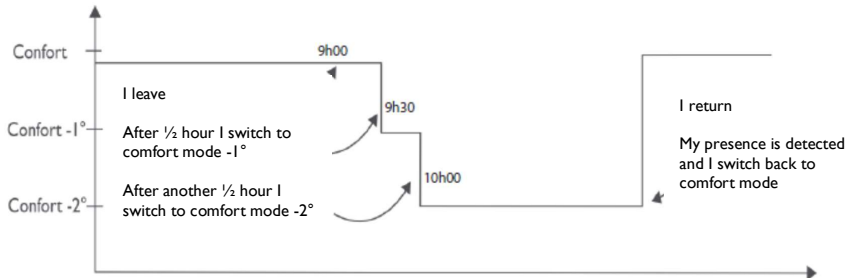

- at 09:00 hrs it detects your absence;
- at 09:30 hrs the operating temperature changes to 18°C;
- at 10:00 hrs the operating temperature changes to 17°C.





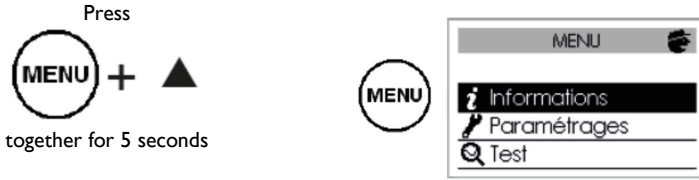







Before performing any action, illuminate the screen by pressing any key.

This menu grants access to the appliance's advanced functions.



 Information	Allows appliance related information to be obtained that may be required if you contact the after-sales department.		
 Configurations	General	Clock	Automatic Summer/Winter Allows activation or deactivation of automatic switching from summer time to winter time. This configuration is active by default. Date and time.
		Language	Allows the language to be selected: French, English.
		Resetting	Used to return to the basic factory settings (depending on the models: Auto mode or Prog mode active, setpoint at 19°C, reduction to -3°C or to -3.5°C, presence detection functions and(or) window open function active).  Pairing between appliances, connection to the app or connection to a control point will be deleted.
	Functions Config.	T° Calibration	Allows the appliance to be calibrated to adjust the setpoint temperature to the temperature recorded in the room if you notice a difference after several hours of heating. The calibration value is between -3°C and +3°C. For example: if the room T° = 18°C and the adjusted T° = 20°C, then select -2.0°.
		Window detection	If paired, allows the function to be deactivated on this appliance only. May be required depending on the configuration of the installation. Deactivating the function on this appliance does not deactivate the function on the other paired appliances. This appliance then adheres to the open window detection operation of the other paired appliances.
		Deletion	Allows the setpoint temperature to be reduced from 1°C to -2°C during peak rate

			periods. You are notified of these periods through the transmission of a private radio message, depending on the system that is installed. This function is available as of the deployment of the EDF LINKY® system and requires the installation of Cozytouch.			
		Indicator light luminosity	Allows the luminosity level of the ring ( <i>on indicator</i> ) to be adjusted  .			
Restrictions	Max. temperature		Allows a maximum setpoint temperature to be recorded that must not be exceeded. It is set to 28°C by default and can be changed ( <i>from 19°C to 28°C</i> ).			
	Access control		Allows the appliance's settings to be partially or fully locked.			
	PIN code		Allows a personal access code to be recorded in the Expert Menu. Once activated, access to the Expert Menu is encoded. Your personal code can be noted here.  <table border="1" data-bbox="591 598 1002 630" style="width: 100%;"><tr><td style="width: 33%; height: 20px;"></td><td style="width: 33%; height: 20px;"></td><td style="width: 33%; height: 20px;"></td></tr></table> To deactivate the code, return to the Expert Menu, enter your personal code, and return to Configurations => Restrictions => PIN Code.			
Connectivities	Send the security key		The security key secures your  installation to prevent interference with nearby equipment. Key exchange  provides the possibility of connecting an  control point to your installation.  Allows the security key to be sent to an  control point.  Use this operation if the appliances are paired.			
	Receive the security key		Allows the security key to be received from an  control point.  Makes existing pairing inoperative if the security key is not transmitted to the other pairs.			
	Authorise connection		Following key exchange, this operation is required to enable connection to an  energy management system that is not part of our brand.			
	Reset Connectivities		Deletes all connectivities ( <i>pairing of appliances, connection to the app, connection to a centralised control point</i> ).			
Test	Heating element		Starts-up the heating element for 5 minutes to check operation.			

	Presence sensor	Activates the sensor to check correct operation ( <i>not available on the low height model</i> ).	
	Radio	Test signal transmission	Checks that there is good radio communication between two appliances by transmitting a signal from one appliance and receiving a signal on the other appliance. If the signal is weak, then there is a risk of losing communication. Check the installation ( <i>distance and/or obstacles between the appliances</i> ).
		Test signal reception	

To exit the Expert Menu:

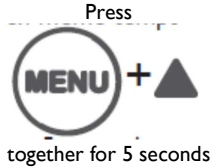

or



### Power cut-off

Our appliances are compatible with various power cut-off systems. However, you should not use power cut-off by interrupting the supply circuit power supply since this system is incompatible with our appliances. Sudden unintentional and repeated interruptions to the electrical power supply can cause wear and damage to the electronic boards that will not be covered by the manufacturer's warranty.



Irrespective of the selected Mode, during power cut-off periods, your appliance will display "Priority power cut-off sequence".

### Help

Problems encountered	Check to be undertaken
The control unit screen does not turn on.	Check that the switch located behind or on the side of the appliance is set to the I position. Check that the appliance is properly powered.
The ring around the "On / Standby" button does not turn on.	Check the luminosity adjustment level ( <i>refer to the Expert Menu Chapter</i> ).
The appliance does not heat up.	If you have accessed programming, check that the programming is set to COMFORT. Check that the installation's circuit-breakers are triggered or even that the cut-off device ( <i>if present</i> ) has not cut-off heating. If the ambient air temperature in the room is higher than the setpoint temperature, then it is normal for the appliance not to heat up. Check that your appliance has not switched to Frost Protection via the pilot wire.

The appliance does not heat up sufficiently.	<p>Increase the Comfort setpoint temperature.</p> <p>If the adjustment is at the maximum, perform the following checks:</p> <ul style="list-style-type: none"> <li>- Check whether the power of your appliance is suitable for the size of your room (<i>we recommend an average of 100 W/m<sup>2</sup> for a ceiling height of 2.50 m or 40 W/m<sup>3</sup></i>);</li> <li>- Ensure that your appliance only heats up the room (<i>door closed</i>);</li> <li>- Check the power supply voltage for the appliance.</li> </ul>
The appliance takes time to heat up.	<p>The electrical resistance heats the fluid, which occurs progressively and naturally as it circulates inside the appliance.</p> <p>The inertia properties of the fluid mean that the surface temperature of the appliance only reaches an optimum level after at least 15 minutes, depending on the ambient temperature and on any losses from the room as the appliance heats up.</p>
The appliance heats up continuously.	Check that the appliance is not located in an air current or that the setpoint temperature adjustment has not been increased.
The control unit is hot.	It is normal for the control unit to be hot when the radiator is on. The surface and component temperatures are compliant with the NF Electricity Performance standard.
The appliance heats up even though the window is open.	There can be a time lag between opening the window and stopping heating ( <i>approximately 15 min</i> ). If this time lag appears to be too long, you can manually switch to frost protection mode.
The surface of the appliance is very hot.	It is normal for the appliance to be hot when it operates, the maximum surface temperature is limited in accordance with the NF Electricity Performance standard. However, if you feel that your appliance is always too hot, check that the power is suitable for the surface area of your room ( <i>we recommend 100 W/m<sup>2</sup> for a ceiling height of 2.50 m or 40 W/m<sup>3</sup></i> ) and that the appliance is not placed in an air current that could interfere with its adjustment.
Traces of dirt appear on the wall around the appliance.	The dirt is associated with poor ambient air quality ( <i>use of a fireplace, candles, cigarette smoke, etc.</i> ). In this case, we recommend checking the correct ventilation of the room ( <i>ventilation, air inlet, etc.</i> ). This dirt does not constitute grounds for warranty replacement of the appliance.
The appliance does not follow the internal programming or the Cozytouch app instructions.	Check that the date and time are set. Check that the appliance is in PROG MODE and that the selected programming source is <b>Programme interne</b> (Internal Program).
The appliance does not follow the Cozytouch app instructions.	Check the connection from the app ( <i>the appliance's indicator light flashes</i> ).
The appliance does not follow the external programming instructions.	<p>Ensure that the programming unit is being used correctly (<i>refer to the unit's operating instructions</i>).</p> <p>Check that the appliance is in PROG MODE and that the selected programming source is <b>Pilotage externe</b> (External Control).</p>

A "paired" appliance does not communicate with the other "paired" appliances.	A maximum of 5 appliances can be paired. The maximum range is from 100 to 300 metres in free-field conditions / for 20 m2 concrete slabs. Check that the appliance is correctly paired ( <i>refer to the "CONNECTIVITIES" chapter</i> ). Delete the entire pairing procedure and restart the procedure ( <i>to perform this operation all the appliances must be turned on</i> ).
The appliance does not connect to the app.	The maximum range between the Cozytouch Bridge and the appliance is from 100 to 300 metres in free-field conditions / for 20 m2 concrete slabs. A maximum of 5 appliances can be connected per room.
The Expert Menu is not accessible.	Have you entered a PIN code? You must enter your code to access the Expert Menu ( <i>refer to the Expert Menu chapter</i> ).

If you have been unable to resolve your problem, please contact a professional with your appliance's references readily available, which can be found on the identification plate (commercial code (C), serial No. (E)), as well as details relating to the room temperature and any programming system you may have. You may also need to provide the information included in the Information section of the Expert Menu.

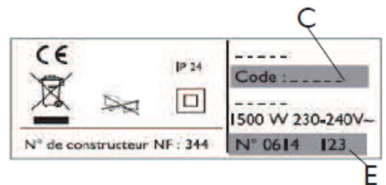

RFN5 - March 2016



T: 0844 3350 549 F: 0844 5436 180  
E: [enquiries@atlantic-heat.co.uk](mailto:enquiries@atlantic-heat.co.uk)  
Atlantic Heat | PO Box 103, National Avenue,  
Kingston Upon Hull, HU5 4JN



Atlantic Heat is part of Ideal Boilers Limited. Ideal Boilers Ltd. pursues a policy of continuing improvement in the design and performance of its products. The right is therefore reserved to vary specification without notice.