

INTERNAL HOUSE INSTALLATIONS



Anti-Wind Cowl

The cowl prevents unwanted rain penetrating the chimney, it is also designed to help with down draughts.



Storm Collar

Used to ensure water tightness when passing through the roof. It protects the flashing from extreme weather conditions and UV.



1000mm Pipe

A fixed one metre length of TWPro twin wall insulated pipe.



Connecting pipe starter length

A rebated slip joint at the bottom allows a connecting pipe to slide inside the main pipe allowing adjustment of up to 200mm. This allows pre installation of the chimney system and allows for safe disconnection of the appliance without disturbing the TWPro.



1000mm Pipe

A fixed one metre length of TWPro twin wall insulated pipe.



Roof Support

Attaches to the rafters in the roof space to help support the chimney.

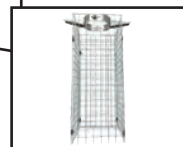
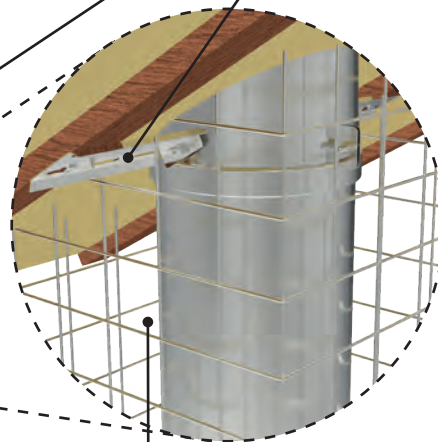

Loft Mesh Kit

Building Control requirement means that the chimney must not be exposed in a usable loft space.



Joist Support

Used to support the chimney as it passes through the floor.

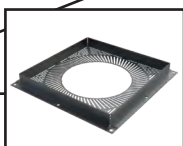

Ventilated Fire Stop Plate

Provides the correct distance to combustible materials when the chimney passes through a floor.

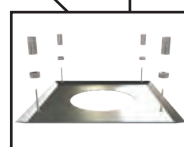
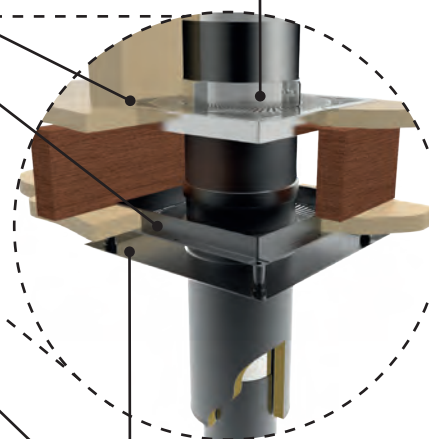

Fire Stop Cover Plate

Designed to cover the fire stop but still allows air to pass through.



VIT Smooth 1000mm Pipe

Vitreous enamel connecting pipe.

EXTERNAL HOUSE INSTALLATIONS



Anti-Wind Cowl

The cowl prevents unwanted rain penetrating the chimney, it is also designed to help with down draughts.



Wall Band

Provides lateral strength to the chimney, should be used every 3 metres.

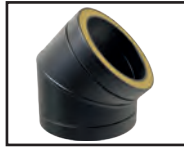

45° Elbow

45° Elbows help create an offset to get round the gutter / overhang.

Long 135° Tee

The Long 135° Tee has an extra long branch that will reach through most standard UK wall constructions.

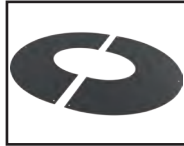

Finishing Plate Round 45°

Fixed to the internal wall will cover any damage made to the wall.

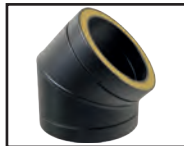

45° Elbow

2 segment 45° elbow.



Adjustable Connecting Pipe

Allows the removal of the stove without disturbing the flue system.



1000mm Pipe

A fixed one metre length of TWPro twin wall insulated pipe.



1000mm Pipe

A fixed one metre length of TWPro twin wall insulated pipe.

Wall Sleeve Adjustable 45°

Protects the chimney in the wall cavity when the flue system passes to the outside wall. The gap between the flue and the Wall Sleeve can be filled with rockwool.

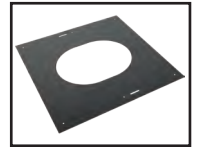
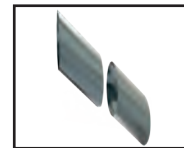

Finishing Plate Square 30°- 45

Fixed to the external wall will keep out water ingress.

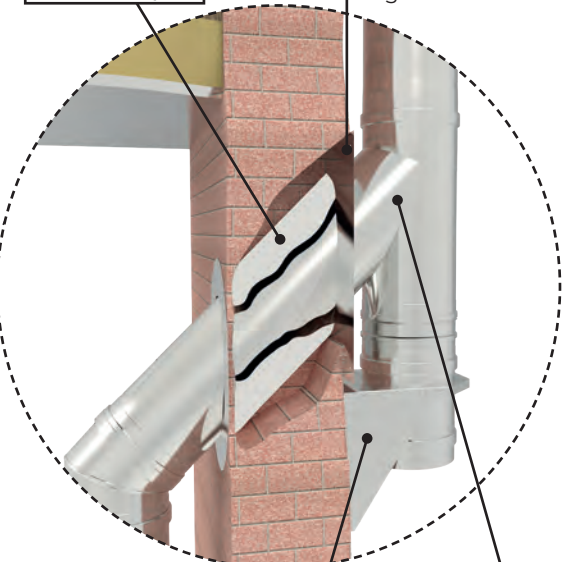

Long 135° Tee

The Long 135° Tee has an extra long branch that will reach through most standard UK wall constructions.



Base Support Plate

Used to provide vertical support at the base of the external flue.



Tee Cap

Attached to the bottom of the external flue allows for easy sweeping.

CHIMNEY LOWERED OR REMOVED



1000mm Pipe

A fixed one metre length of TWPro twin wall insulated pipe.



Anti-Wind Cowl

The cowl prevents unwanted rain penetrating the chimney. It is also designed to help with down draughts.



Storm Collar

Used to ensure water tightness when passing through the roof. It protects the flashing from extreme weather conditions and UV.



TILEFlash EPDM Aluminium Base

Used to seal the roof where the flue has penetrated it.



Roof Support

Attaches to the rafters in the roof space to help support the chimney.



1000mm Pipe

A fixed one metre length of TWPro twin wall insulated pipe.



Locking Band

The Locking Band is used to secure two parts of the flue together.



1000mm Pipe

A fixed one metre length of TWPro twin wall insulated pipe.

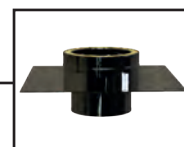

Push Fit Chest Mounting Plate

Transitional plate that converts flexible flue liner to TWPro.

TWPro
FitSystem[®]

FLEX RELINING WITH CHIMNEY BEING LOWERED



Anti-Wind Cowl

The cowl prevents unwanted rain penetrating the chimney, it is also designed to help with down draughts.



1000mm Pipe

A fixed one metre length of TWPro twin wall insulated pipe.



Storm Collar

Used to ensure water tightness when passing through the roof. It protects the flashing from extreme weather conditions and UV.

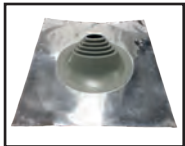

Residential Flashing EPDM

Used to seal the roof where the flue has penetrated it.

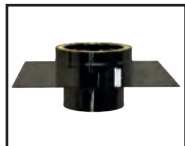

Push Fit Chest Mounting Plate

Transitional plate that converts flexible flue liner to TWPro.



Mi-Flex Flue Liner

Stainless steel flexible flue liner used to reline an existing chimney.



Register Plate

Used to seal off the base of the chimney opening.



Roof Support

Attaches to the rafters in the roof space to help support the chimney.

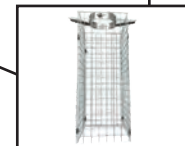
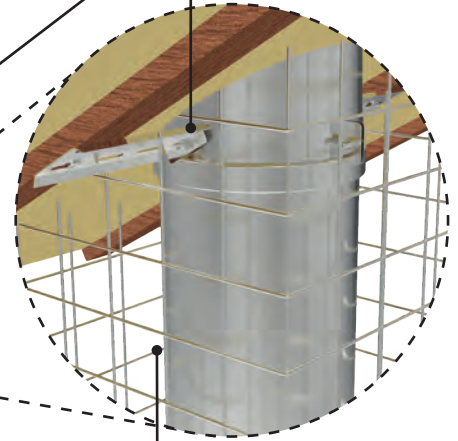

Loft Mesh Kit

Building Control requirement means that the chimney must not be exposed in a usable loft space.



1000mm Pipe

A fixed one metre length of TWPro twin wall insulated pipe.



Stove Pipe to Flex Adaptor

Used to convert from enamel pipe to flexible flue liner with a screwfix adaptor.



VIT Smooth 1000mm Pipe

Vitreous enamel connecting pipe.

