

PACKAGED HEAT PUMP SOLUTIONS



For more products
and information visit:

www.jouleuk.co.uk

SAL-0010-3



KODIAK COILS
Smooth Tube
High Efficiency

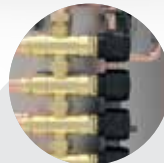

ACCTUATORS
Accurate
Zone Control



PCB
ELECTRIC BOARD
Easy Wiring



KODIAK MAINFOLD
Simple Assembly

INTRODUCING THE JOULE AIR SOURCE HEAT PUMP POWERED BY SAMSUNG

The ultimate in home climate convenience is here, thanks to ClimateHub - Samsung's new integrated solution for heating and domestic hot water supply.

With straightforward installation, smooth commissioning, quiet operation and smart connectivity, maintaining home comfort has finally been made easy.



The Technology - Air Source Heat Pumps

A heat pump is an energy-efficient system that uses the heat from the ambient air for heating and hot water. By using the ambient air and transferring this heat into the house through a hydronic system, such as underfloor heating, a heat pump requires less power input and offers greater power output than conventional boilers.



Quiet Operation

SAMSUNG IN QUIET MODE IS QUIETER THAN MITSUBISHI ULTRA QUIET

Today's climate systems need to meet increasingly strict sound level requirements and limit aural disturbance around the home. The Samsung ClimateHub system's 4-Step Quiet Mode allows users to reduce noise levels of the heat pump outdoor unit to as low as 35dB(A).



Smart Connectivity

CONNECTS INTO SMART THINGS CONTROL ENVIRONMENT

The ClimateHub system can be managed remotely. Using the optional Wi-Fi kit, users can control different aspects of the system through the Samsung SmartThings app - turn it on and off, control the functions and schedule its operation, from anywhere

How it works?

A heat pump is an electrical device that extracts heat from one place and transfers it to another. The heat pump is not a new technology; it has been used around the world for decades. Refrigerators and air conditioners are both common examples of this technology.

Heat pumps transfer heat by circulating refrigerant through a cycle of evaporation and condensation. A compressor pumps the refrigerant between two heat exchanger coils. In one coil, the refrigerant is evaporated at low pressure and absorbs heat from its surroundings.

The refrigerant is then compressed en route to the other coil, where it condenses at high pressure. At this point, it releases the heat it absorbed earlier in the cycle.

Refrigerators and air conditioners are both examples of heat pumps operating only in the cooling mode. A refrigerator is essentially an insulated box with a heat pump system connected to it.



**For every 1 kWh
of energy input**

=

An air source heat pump
can deliver up to more than
4 kWh in energy output.

This is an energy efficiency ratio of more than **400%**, which is far superior to high energy efficiency boiler systems. Our heatpump packages have class leading SCOP.

Air Source Heat Pump Benefits

- Compatible with all low temp. systems
- High seasonal energy efficiency
- Up to 60°C water supply
- Easy to install - Easy to control
- Operation Range down to -20°C
- Higher capacity at low ambient temperature

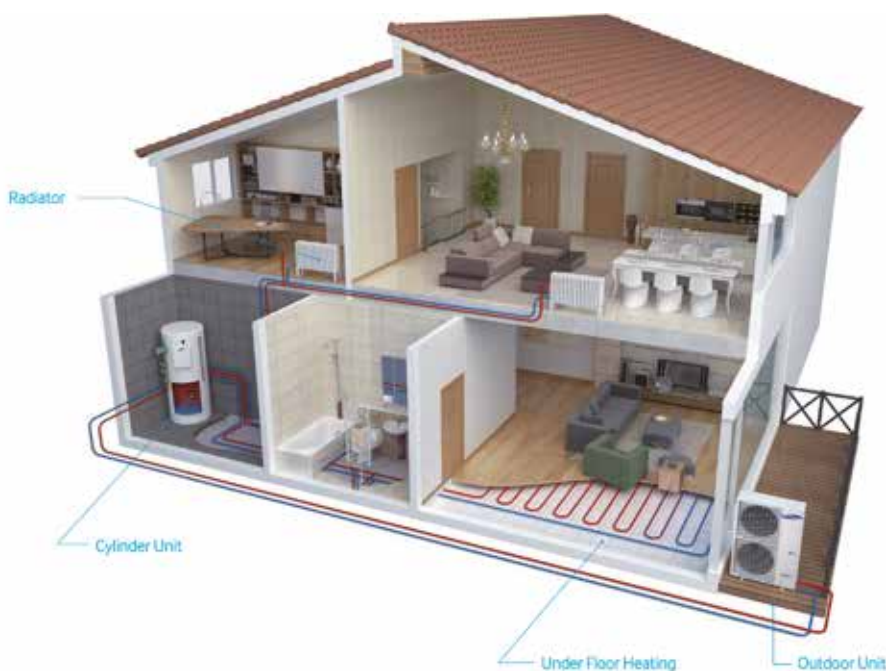

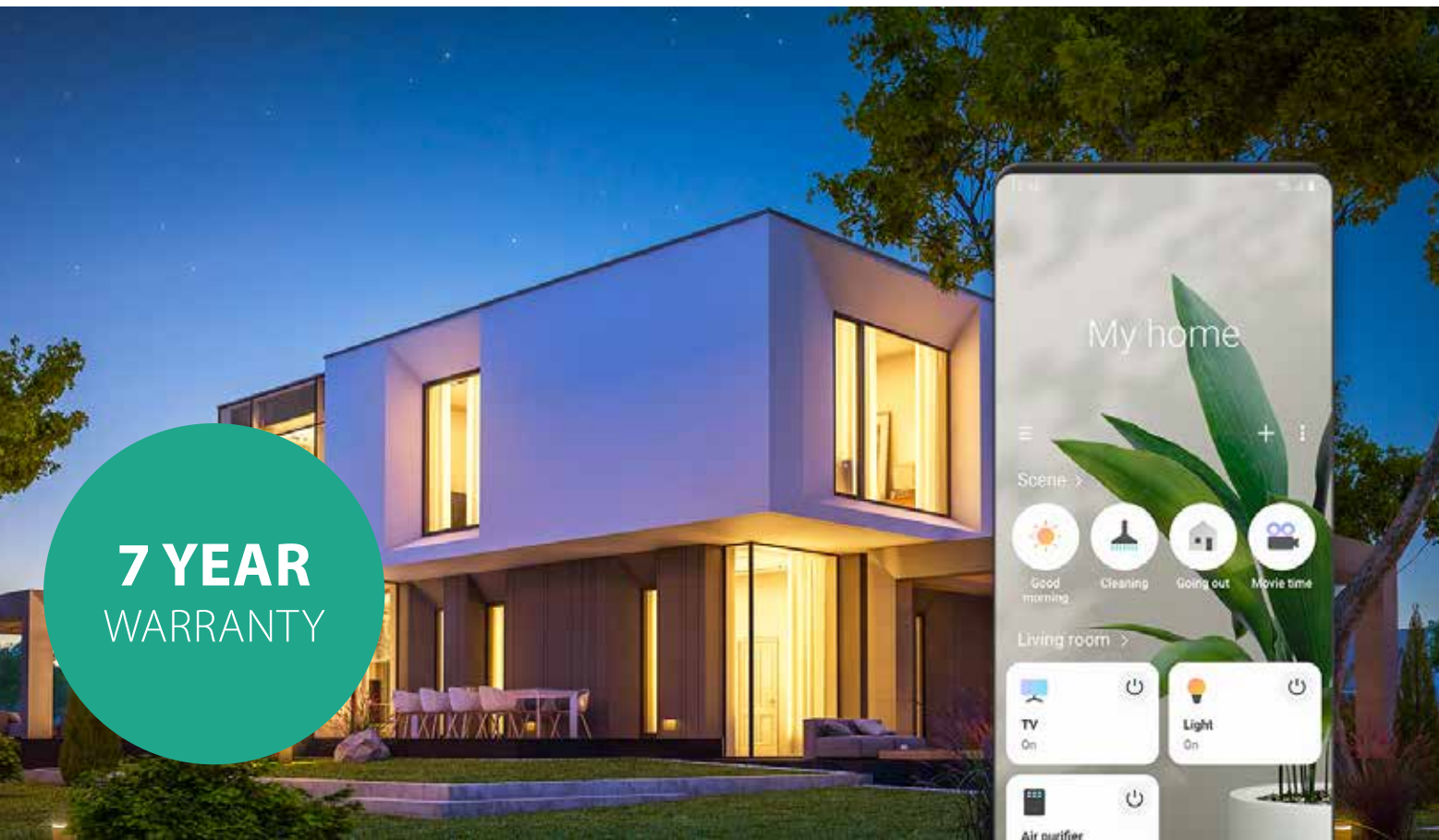

**7 YEAR
WARRANTY**

Hands-free control.

Use Bixby on your Galaxy phone to control your smart devices with your voice.



Smart Applications:

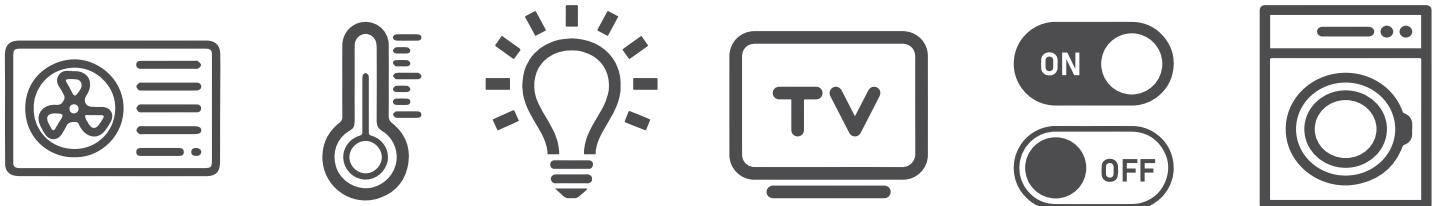

More available at: <https://www.samsung.com/uk/apps/smartthings/>

More smart devices, one smart app.

Connect, automate, and manage all your Samsung and SmartThings-compatible appliances and electronics with a single, easy-to-use app, because smart should be simple however many devices you bring home.

CONNECTS INTO SMART THINGS CONTROL ENVIRONMENT

Connect to your heatpump and smart cylinder from the comfort of your living room.



One app, multiple screens.

Access SmartThings features across a family of Samsung products, including smart phones, TVs, and fridges.

Your home, your way.

Make your home smarter with custom automation. Create schedules and scenarios, and let SmartThings do the rest.

It can even suggest new smart ways to automate your day.

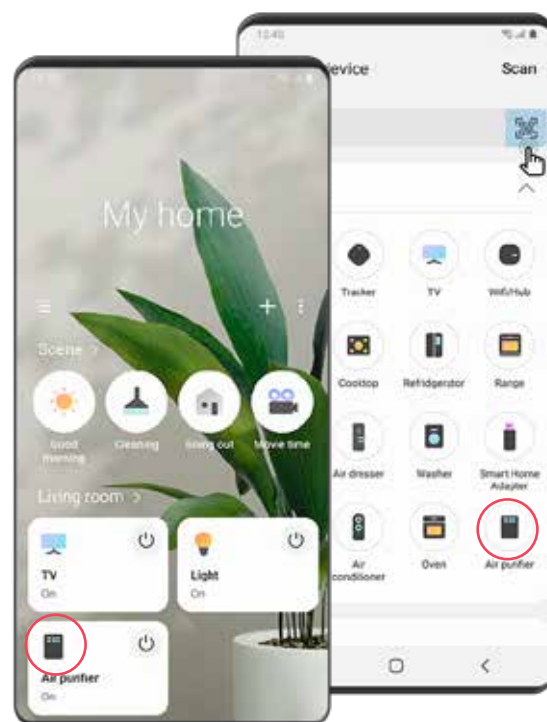

KODIAK Cylinder



Joule Unvented Cylinder - Kodiak Features

KODIAK Cylinder

The Joule Kodiak cylinder provides improved performance and faster heat up times using our redesigned smooth tube coil.

Pre-plumbed cylinders come complete with integrated hydraulic components and advance controls.

Designed to minimise floor space and footprint whilst still offering optimum performance, the cylinder completely integrates with the Samsung monobloc air source heat pump range.

The next generation compact Pre-Plumbed pack is designed to control the distribution of heat to each zone.

A unique, patented, modular zonal control manifold for heating and hot water systems. Joule have optimised the layout of the pre-plumb developing a patented hydraulic design while also making it easier and faster to install the cylinder with improved access for the installer.

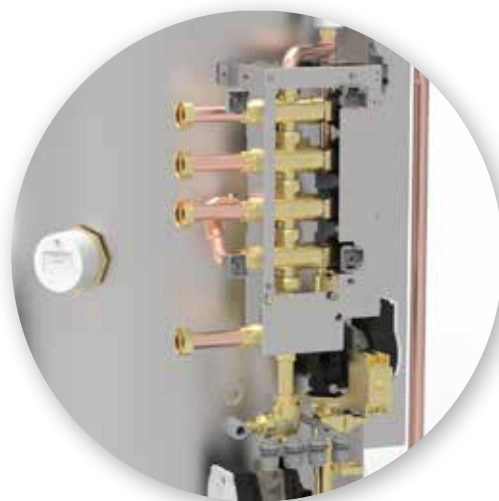

The hydraulic heating control section consists of:

- 2-port valve and actuators
- ERP rated 7 metre circulating pump
- Pre-plumb hot water pipework
- By-pass valve
- Filling point connection
- Automatic air vent

Joule-Samsung

Air Source Heat Pump Product Range



R32 Outdoor Unit

HHSM -G600005-1	HHSM -G600008-1	HHSM- G600012-1	HHSM- G600016-1	HHSM G600016-3
--------------------	--------------------	--------------------	--------------------	-------------------

Capacity		5kW	8kW	12kW	16kW	16kW
Power		1Φ				3Φ
Packaged						
HUGH-180COM-3C	180L COMPACT	●	●	●	●	
HUGH-230COM-3C	230L COMPACT	●	●	●	●	
Pre-Plumbed						
HUGH-G6150-L3C	150L STANDARD	●	●			
HUGH-G6170-L3C	170L STANDARD	●	●	●		
HUGH-G6200-L3C	200L STANDARD	●	●			
HUGH-G6250-L3C	250L STANDARD		●	●	●	●
HUGH-G6300-N3C	300L STANDARD			●	●	●
HUGH-G6150-S3C	150L SLIMLINE	●	●			
HUGH-G6170-S3C	170L SLIMLINE	●	●	●		
HUGS-G6200-L3C	200L SOLAR	●				
HUGS-G6250-N3C	250L SOLAR			●	●	●
HUGS-G6300-N3C	300L SOLAR		●		●	●
Standalone						
	1PH SO SYS	●	●	●	●	
	3PH SO SYS				●	●
Buffer						
HUGH-G61860-3C	MONO 180/60L	●	●	●		
HUGH-G62060-3C	MONO 200/60L	●	●	●	●	●
HUGH-G62590-3C	MONO 250/90L		●	●	●	●
HUGH-G64013-3C	MONO 300/130L		●	●	●	●
HUGH-G64013-3C	MONO 400/130L			●	●	●



Tank Integrated Hydro Unit
& Smart Plumb Cylinder

Joule Air Source Heat Pumps - Specification

Joule-Samsung Mono Specification



		Outdoor Unit			HHSM-G600005-1	HHSM-G600008-1	HHSM-G600012-1	HHSM-G600016-1
		Controller			HZSMC-G6000000	HZSMC-G6000000	HZSMC-G6000000	HZSMC-G6000000
System	Operation	Nominal Capacity	Heating A7/W35 ¹ /A7/W55 ²	W	5.000/4.300	8.000/7.100	12.000/11.300	16.000/15.000
			Cooling A35/W18 ¹	W	5.000	7.500	12.000	14.000
		Power Input (Nominal)	Heating A7/W35 ¹ /A7/W55 ²	W	1.030/1.520	1.770/2.530	2.650/3.730	3.620/5.180
			Cooling A35/W18 ¹	W	1.140	1.900	2.770	3.280
		COP (Nominal Heating) A7/W35 ¹ /A7/W55 ²	W/W	4,85/2,83	4,52/2,81	4,53/3,03	4,42/2,90	
		EER (Nominal Cooling) A35/W18 ¹	W/W	4,39	3,95	4,33	4,27	
		SCOP LWT 350 ^o /550 ^o	W/W	4,46/3,2	4,44/3,23	4,69/3,51	4,48/3,53	
		Average Seasonal Space Heating Eff.Class*	-	A+++ / A++	A+++ / A++	A+++ / A++	A+++ / A++	
		Current	MCA	A	16,00	22,00	28,00	32,00
			MFA	A	20,00	27,50	35,00	40,00
		Water Flow Rate	Min	l/min	7,00	7,00	12,00	12,00
			Max	l/min	48,00	48,00	58,00	58,00
		Leaving Water Temp	Heating	°C	15-65	15-65	15-65	15-65
			Cooling	°C	5-25	5-25	5-25	5-25
		Function	Smart Grid Ready	-	●	●	●	●
			PV Enabled	-	●	●	●	●
	2-Zone Control		-	●	●	●	●	
Indoor Compact Unit	Power Supply		0,#,V,Hz	220-240V, 50Hz, 1	220-240V, 50Hz, 1	220-240V, 50Hz, 1	220-240V, 50Hz, 1	
	Water Tank Volume		Litres	180/230	180/230	180/230	180/230	
	Declared Load Profile		L/XL					
	Energy Efficiency Class		-	A	A	A	A	
	Sound	Sound Pressure	Heating/ Cooling Std	dB(A)				
		Sound Power	Heating Std	dB(A)				
	Dimensions	Net Weight		kg	58.5	76.0	110.0	110.0
Net Dimensions (WxHxD)			mm	798x 880 x 310	998 x 940 x 330	1420 x 940 x 330	1420 x 940 x 330	
Outdoor Unit	Power Supply		0,#,V,Hz	10,220-240V,50Hz	10,220-240V,50Hz	10,220-240V,50Hz	10,220-240V,50Hz	
	Compressor	Type	-	BLDC Twin Rotary	BLDC Twin Rotary	BLDC Twin Rotary	BLDC Twin Rotary	
	Base Heater		-	--	●	●	●	
	Sound	Sound	Heating Std	dB(A)	45	48	50	52
		Pressure	Cooling Std	dB(A)	45	48	50	54
		Sound	Heating Std	dB(A)	61	63	64	66
		Power	Cooling Std	dB(A)	62	64	65	68
	Dimensions	Net Weight		Kg	58.5	76	110	110
		Net Dimensions (WxHxD)		mm	880 x 798 x 310	940 x 998 x 330	940 x 1420 x 330	940 x 1420 x 330
	Refrigerant	Type		-	R32	R32	R32	R32
		Factory Charging		tC02e	0,68	0,78	1,49	1,49
			kg		1,00	1,15	2,20	2,20
Piping	Water Pipe	Inlet/Outlet	Ø,mm	28/28	28/28	28/28	28/28	
	Water Pipe (DHW)	Inlet/Outlet	Ø,mm	22/22	22/22	22/22	22/22	
Operation	Ambient Temperature	Heating	°C	-25-35	-25-35	-25-35	-25-35	
		Cooling	°C	10-46	10-46	10-46	10-46	
		DHW	°C	-25-43	-25-43	-25-43	-25-43	

Joule Air Source Heat Pumps - Specification

Maximum Heating Capacity (Integrated Value)

LWT (Leaving Water Temp.), Tamb (Ambient Temp.), HC (Heating Capacity), PI (Power input)

HHSM-G600005-1	LWT(°C) 30		35		40		45		50		55		60		65		
	Tamb(°C)	HC(KW)	PI(KW)	HC(KW)	PI(KW)	HC(KW)	PI(KW)	HC(KW)	PI(KW)	HC(KW)	PI(KW)	HC(KW)	PI(KW)	HC(KW)	PI(KW)	HC(KW)	PI(KW)
-20	3.57	1.42	3.40	1.60	3.41	1.69	3.43	1.98									
-15	4.47	1.63	4.26	1.83	4.12	1.92	3.99	2.00	3.87	2.10							
-10	5.15	1.69	4.90	1.90	4.75	1.99	4.61	2.08	4.47	2.18	4.15	2.39					
-7	5.36	1.67	5.10	1.88	4.99	2.12	4.88	2.36	4.78	2.58	4.67	2.79					
-2	5.20	1.48	4.95	1.67	4.76	1.83	4.58	1.99	4.35	2.24	4.12	2.49	3.90	2.76			
2	5.04	1.29	4.80	1.45	4.54	1.54	4.27	1.62	4.06	1.82	3.84	2.03	3.64	2.25			
7	5.25	0.92	5.00	1.03	4.90	1.17	4.80	1.30	4.55	1.41	4.30	1.52	4.08	1.56	3.85	1.60	
10	5.73	0.92	5.46	1.04	5.38	1.18	5.29	1.31	5.03	1.48	4.76	1.64	4.53	1.69	4.29	1.74	
15	6.54	0.94	6.23	1.05	6.17	1.18	6.12	1.33	5.81	1.50	5.51	1.66	5.23	1.72	4.95	1.77	
20	7.35	0.95	7.00	1.07	6.97	1.20	6.94	1.35	6.56	1.52	6.25	1.69	5.93	1.74	5.62	1.79	

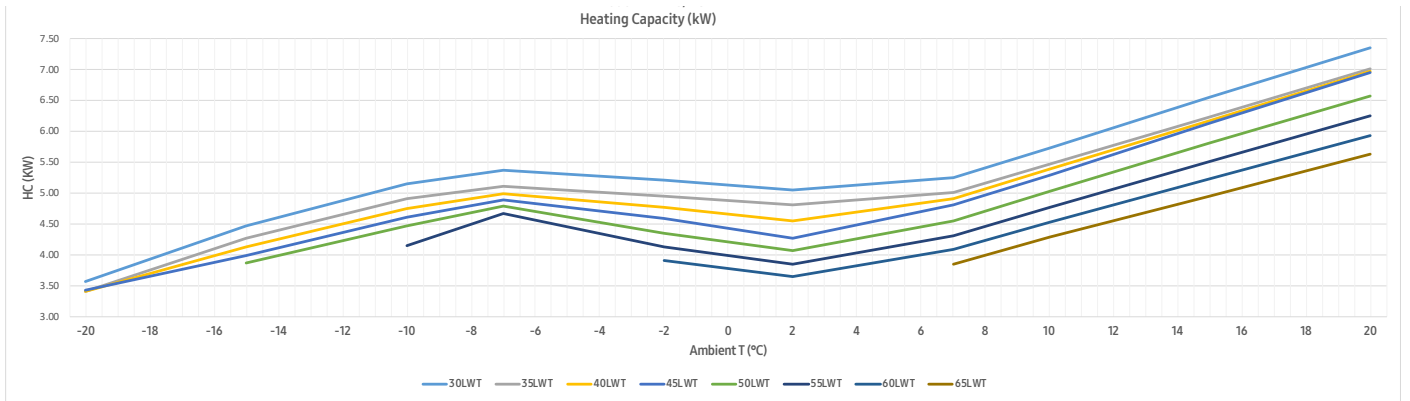

HHSM-G600008-1	LWT(°C) 30		35		40		45		50		55		60		65		
	Tamb(°C)	HC(KW)	PI(KW)	HC(KW)	PI(KW)	HC(KW)	PI(KW)	HC(KW)	PI(KW)	HC(KW)	PI(KW)	HC(KW)	PI(KW)	HC(KW)	PI(KW)	HC(KW)	PI(KW)
-20	5.60	2.21	5.33	2.48	5.27	2.70	5.20	3.13									
-15	6.56	2.42	6.25	2.72	6.15	2.94	6.06	3.16	5.88	3.32							
-10	7.86	2.66	7.49	2.99	7.26	3.14	7.04	3.28	6.83	3.45	6.33	3.77					
-7	7.72	2.69	7.35	3.02	7.13	3.17	6.91	3.32	6.31	3.56	5.71	3.85					
-2	7.53	2.39	7.18	2.69	6.94	2.83	6.71	2.97	6.37	3.34	6.03	3.71	5.72	4.13			
2	7.35	2.09	7.00	2.35	6.75	2.49	6.50	2.62	6.18	2.95	5.85	3.28	5.54	3.64			
7	8.40	1.58	8.00	1.70	7.70	1.95	7.40	2.12	7.25	2.33	7.10	2.53	6.96	2.62	6.81	2.72	
10	9.23	1.57	8.79	1.77	8.53	1.97	8.28	2.17	7.86	2.44	7.45	2.71	7.08	2.79	6.70	2.88	
15	10.60	1.56	10.10	1.76	9.92	1.97	9.74	2.24	9.25	2.52	8.76	2.80	8.33	2.89	7.89	2.98	
20	11.98	1.56	11.41	1.75	11.31	2.01	11.20	2.32	10.64	2.61	10.08	2.90	9.58	2.99	9.07	3.08	

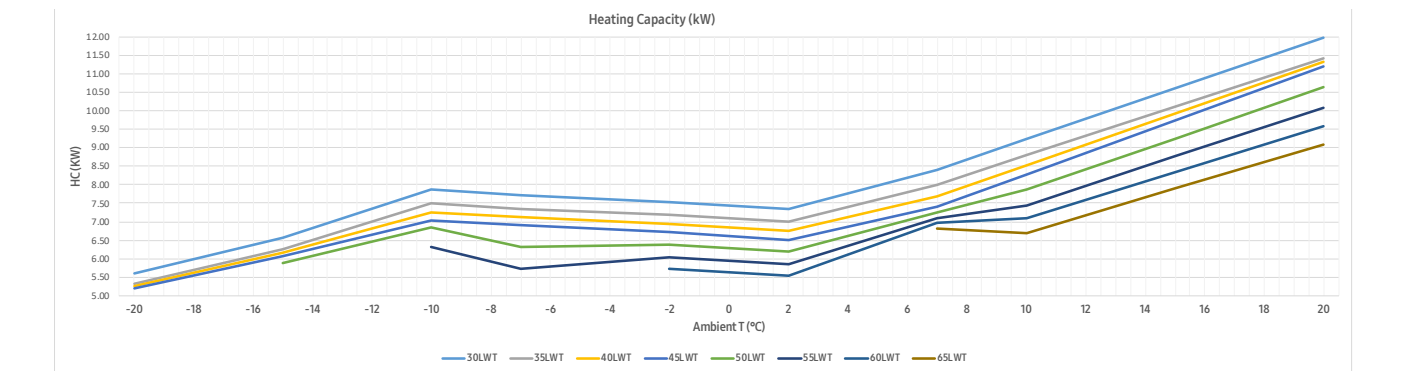

1. Heating capacity: Capacity is according to Eurovent rating standard OM-3-207 5 and valid for heated water range $\Delta t = 3 - 8^\circ\text{C}$

2. Cooling capacity: Capacity is according to Eurovent rating standard OM-3-207 5 and valid for chilled water range $\Delta t = 3 - 8^\circ\text{C}$

3. Power input: Power input is according to Eurovent rating standard OM-3-2015.

4. Peak value: Tested without defrost operation in accordance with EN7 457 7
* The real capacity would be changed according to the install environment.

Joule Air Source Heat Pumps - Specification

Maximum Heating Capacity (Integrated Value)

LWT (Leaving Water Temp.), Tamb (Ambient Temp.), HC (Heating Capacity), PI (Power input)

HHSM-G600012-1	LWT(°C) 30		35		40		45		50		55		60		65		
	Tamb(°C)	HC(KW)	PI(KW)	HC(KW)	PI(KW)	HC(KW)	PI(KW)	HC(KW)	PI(KW)	HC(KW)	PI(KW)	HC(KW)	PI(KW)	HC(KW)	PI(KW)	HC(KW)	PI(KW)
-20	9.82	4.08	9.35	4.58	9.04	4.68	8.72	4.88									
-15	11.02	4.21	10.49	4.73	10.33	4.83	10.16	4.93	9.85	5.18							
-10	12.14	4.23	11.56	4.75	11.22	4.94	10.87	5.12	10.54	5.38	9.78	5.89					
-7	12.60	4.19	12.00	4.71	11.47	5.18	10.94	5.64	10.41	6.11	9.87	6.57					
-2	11.97	3.56	11.40	4.01	11.19	4.48	10.98	4.95	10.43	5.56	9.88	6.18	9.36	6.87			
2	11.34	2.94	10.80	3.30	10.91	3.78	11.02	4.25	10.47	4.78	9.92	5.31	9.40	5.90			
7	12.60	2.36	12.00	2.65	11.85	2.92	11.70	3.18	11.50	3.46	11.30	3.73	11.11	3.83	10.91	3.94	
10	13.91	2.34	13.25	2.63	13.06	2.88	12.87	3.14	12.22	3.53	11.58	3.92	11.00	4.05	10.42	4.17	
15	16.09	2.30	15.32	2.59	15.07	2.79	14.81	3.07	14.07	3.45	13.33	3.84	12.66	3.96	11.99	4.08	
20	18.27	2.27	17.40	2.55	17.08	2.75	16.75	3.00	15.91	3.38	15.08	3.75	14.32	3.87	13.57	3.98	

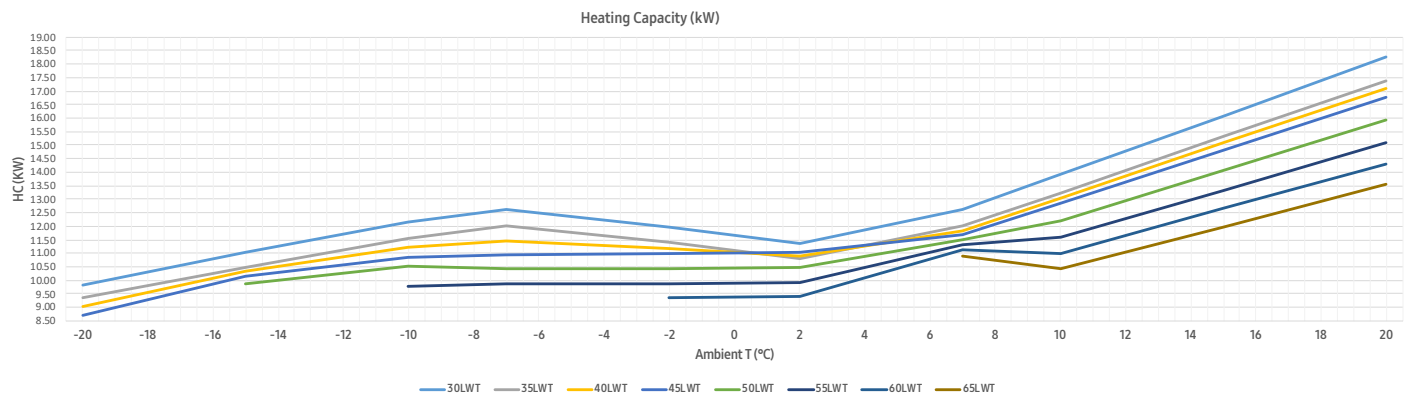

HHSM-G600016-1	LWT(°C) 30		35		40		45		50		55		60		65		
	Tamb(°C)	HC(KW)	PI(KW)	HC(KW)	PI(KW)	HC(KW)	PI(KW)	HC(KW)	PI(KW)	HC(KW)	PI(KW)	HC(KW)	PI(KW)	HC(KW)	PI(KW)	HC(KW)	PI(KW)
-20	11.87	5.05	11.30	5.67	10.99	6.04	10.68	6.61									
-15	13.51	5.29	12.87	5.94	12.66	6.31	12.44	6.67	12.07	7.01							
-10	14.82	5.36	14.11	6.03	13.67	6.48	13.27	6.94	12.87	7.28	11.94	7.98					
-7	15.33	5.34	14.60	6.00	14.66	6.77	14.71	7.53	13.79	7.64	12.86	7.75					
-2	14.60	4.63	13.90	5.20	13.41	5.65	12.93	6.10	12.28	6.86	11.63	7.62	11.02	8.47			
2	13.86	3.92	13.20	4.40	12.17	4.53	11.14	4.66	10.58	5.24	10.03	5.83	9.50	6.47			
7	16.80	3.22	16.00	3.62	15.70	4.06	15.40	4.49	15.20	4.84	15.00	5.18	14.81	5.28	14.61	5.38	
10	18.25	3.26	17.38	3.66	17.09	4.10	16.80	4.54	15.96	5.10	15.12	5.67	14.37	5.82	13.61	6.02	
15	20.68	3.33	19.69	3.74	19.42	4.11	19.14	4.61	18.18	5.19	17.23	5.77	16.37	5.95	15.50	6.13	
20	23.10	3.39	22.00	3.81	21.74	4.21	21.48	4.69	20.41	5.28	19.33	5.86	18.37	6.05	17.40	6.23	

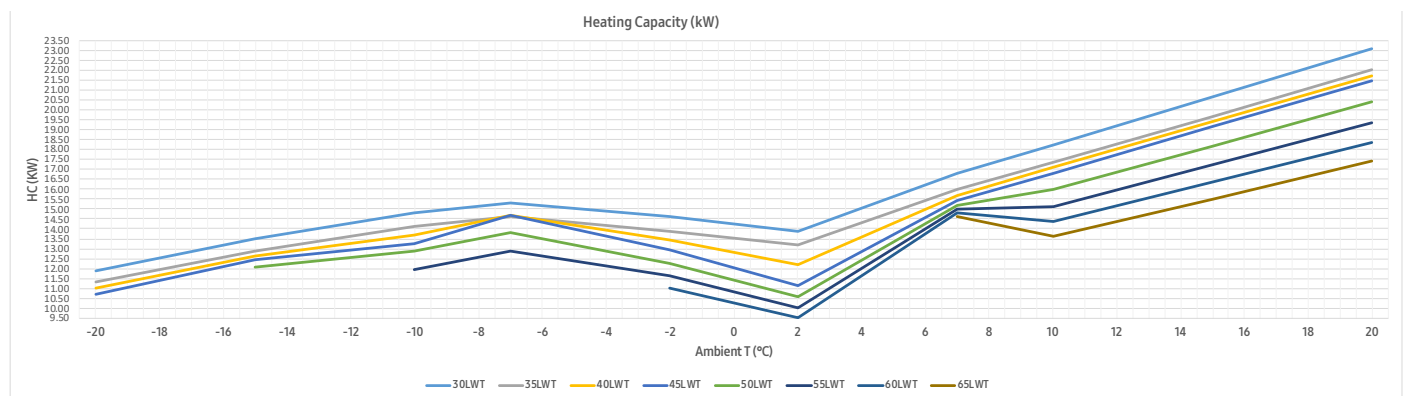

1. Heating capacity: Capacity is according to Eurovent rating standard OM-3-207 5 and valid for heated water range L_t:t = 3~8°C

3. Power input: Power input is according to Eurovent rating standard OM-3-2015.

2. Cooling capacity: Capacity is according to Eurovent rating standard OM-3-207 5 and valid for chilled water range L_t:t = 3~8°C

4. Peak value: Tested without defrost operation in accordance with EN7 457 7
* The real capacity would be changed according to the install environment.

Joule Air Source Heat Pumps - Sound Data



Silent mode

In this mode max compressor frequency and max outdoor unit fan speed are limited.

Step 1					
Outdoor Unit	Sound Power dB(A) ²	Output (kW) ¹	Correction Factor	Corrected Output (kW)	Corrected Sound Power dB(A) ²
HHSM-G600005-1	61	4.97	0.87	4.32	58
HHSM-G600008-1	63	7.56	0.87	6.58	60
HHSM-G600012-1	64	12.81	0.87	11.14	61
HHSM-G600016-1	66	12.95	0.87	11.27	63

Step 2					
Outdoor Unit	Sound Power dB(A) ²	Output (kW) ¹	Correction Factor	Corrected Output (kW)	Corrected Sound Power dB(A) ²
HHSM-G600005-1	61	4.97	0.78	3.88	56
HHSM-G600008-1	63	7.56	0.78	5.90	58
HHSM-G600012-1	64	12.81	0.78	9.99	59
HHSM-G600016-1	66	12.95	0.78	10.10	61

Step 3					
Outdoor Unit	Sound Power dB(A) ²	Output (kW) ¹	Correction Factor	Corrected Output (kW)	Corrected Sound Power dB(A) ²
HHSM-G600005-1	61	4.97	0.64	3.18	54
HHSM-G600008-1	63	7.56	0.64	4.84	56
HHSM-G600012-1	64	12.81	0.64	8.20	57
HHSM-G600016-1	66	12.95	0.64	8.29	59

*1 These capacities are calculated at A2/W45.

*2 Sound pressure values for heating mode.

Joule Air Source Heat Pumps - SAP Database



Joule Item Code	HHSM-G600005-1	HHSM-G600005-1	HHSM-G600005-1	HHSM-G600008-1	HHSM-G600008-1	HHSM-G600008-1
Index number	104359	104360	104361	104367	104368	104369
Model name	AE050RXYDEG	AE050RXYDEG	AE050RXYDEG	AE080RXYDEG	AE080RXYDEG	AE080RXYDEG
Fuel	Electricity					
Heat emitter	Flow temp <= 55°C	Flow temp <= 45°C	Flow temp <= 35°C	Flow temp <= 55°C	Flow temp <= 45°C	Flow temp <= 35°C
Output power (kW) [@-4.7°C]	4.400	4.830	5.090	7.270	7.970	7.270
Reversible	No					
Heat source	Air					
Service provision	Space and water heating all year					
Heating duration						
Weather Compensation	Yes					
HW vessel	Separate and specified vessel					
HW volume (l)	150					
HW heat loss rate (kWh/day)	1.770					
HW heat exchanger area (m2)	0.950	0.950	0.950	1.250	1.250	1.250



Joule Item Code	HHSM-G600012-1	HHSM-G600012-1	HHSM-G600012-1	HHSM-G600016-1	HHSM-G600016-1	HHSM-G600016-1
Index number	104375	104376	104377	104383	104384	104385
Model name	AE120RXYDEG	AE120RXYDEG	AE120RXYDEG	AE160RXYDEG	AE160RXYDEG	AE160RXYDEG
Fuel						
Heat emitter	Flow temp <= 55°C	Flow temp <= 45°C	Flow temp <= 35°C	Flow temp <= 55°C	Flow temp <= 45°C	Flow temp <= 35°C
Output power (kW) [@-4.7°C]	10.580	11.610	11.690	14.180	15.550	14.430
Reversible	No					
Heat source	Air					
Service provision	Space and water heating all year					
Heating duration						
Weather Compensation	Yes					
HW vessel	Separate and specified vessel					
HW volume (l)	150					
HW heat loss rate (kWh/day)	1.770					
HW heat exchanger area (m2)	1.800	1.800	1.800	1.800	1.800	1.800

Joule Cylinders- Standard & Slimline Pre-Plumb

Standard Pre-Plumbed & Slimline Pre-Plumbed Cylinder For Joule Samsung Monobloc Units

Joule hot water cylinders are next generation in pre-plumbed hot water solutions. With its sleek design and pre plumbed architecture the space requirements for the pre-plumbed hot water cylinder have been reduced dramatically.

Our slimline models have been designed for the use in tight areas where there is more height than width available.

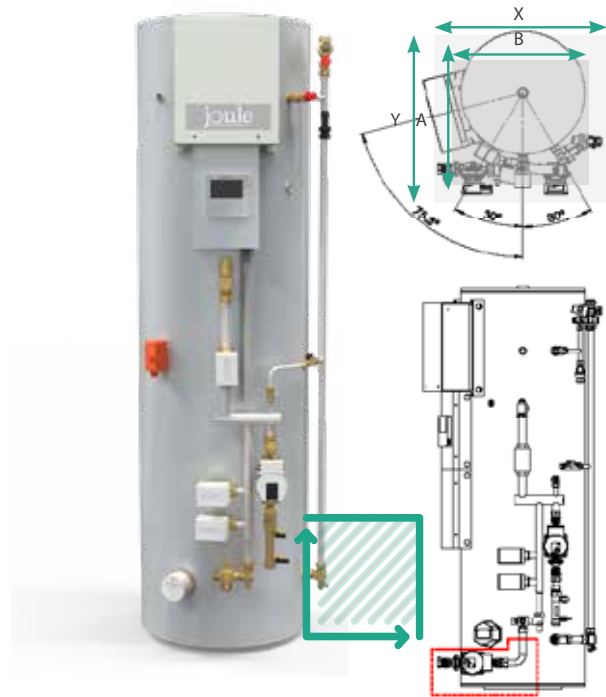

CYLINDER		HUGH-G6150-L3C	HUGH-G6170-L3C	HUGH-G6200-L3C	HUGH-G6250-N3C	HUGH-G6300-N3C	HUGH-G6150-S3C	HUGH-G6170-S3C	HUGH-G6205-S3C	
NOMINAL HOT WATER VOLUME (LITRES)		150	170	200	250	300	150	170	205	
ErP RATING		C	C	C	C	C	C	C	C	
STANDING LOSS (W)		55	66	81	89	92	70	79	84	
HEAT UP TIME (MINS)		10	10	11	14	17	26	27	31	
WATER	Primary Circuit Pump	Wilo- Yonos PARA RS 15/7.0 iPWM1 130 12								
	Heating Circuit Pump									
	Connection Size (mm) Heating / DHW									22 / 22
WATER SAFETY	Water Circuit	Control Thermistor (°C)								
	DHW Cylinder	DHW Expansion Vessel (Litres)	18	18	18	18	24	18	18	18
		Control Thermistor (°C)	75	75	75	75	75	75	75	75
		Over Temperature Cut-Out (°C)	80 ± 5							
		Temp and Pressure Relief Valve (°C) / (MPa (Bar))	90 / 1.0 (10)							
		Expansion Relief Valve (Cold) (MPa (Bar))	0.6 (6)							
DIMENSIONS (mm)	Height	1190	1310	1490	1815	1600	1335	1535	1880	
	Width	540	540	540	540	600	475	475	475	
FOOTPRINT (mm)	Length (A)	740				800	675	675	675	
	Width (B)	740				800	675	675	675	
FREE FLOOR SPACE (mm)	Length (X)	1290				1350	1225			
	Width (Y)	840				900	775			
WEIGHT EMPTY / FULL (kg)		46/196	54/223	58/256	67/316	74/372	35/175	39/199	43/230	
CYLINDER MATERIAL	Cylinder	Stainless Steel Duplex LDX 2101								
	Insulation	Insulation Type	Polyurethane foam CFC-Free and HCFC Free							
		Insulation Thickness (mm)	50							
		GWP of Insulation	3.1							
		ODP of Insulation	0							
ELECTRICAL DATA	Electrical Supply MIM	220-240v, 50Hz								
	Phase	Single								
	Fuse Rating - MCB Sizes (A)*1	20								
	Imerssion Capacity (kW)	3								
	Max Running Current (A)	13								
	Fuse Rating - MCB Sizes (A)*1	20								

Joule Cylinders - Standard & Slimline Electrical Diagram

F	Samsung Outdoor Unit	V2	Heating Zone Valve 1
D	Flow Sensor	V3	Heating Zone Valve 2
P1	Primary Circulating Pump	E	Samsung Control Unit
P2	Heating Return Pump	C	High Limit Stat
V1	DHW Zone Valve	B	Standard Pre Plumb Cylinder
A	30A ELCB	H	Joule Room Thermostat

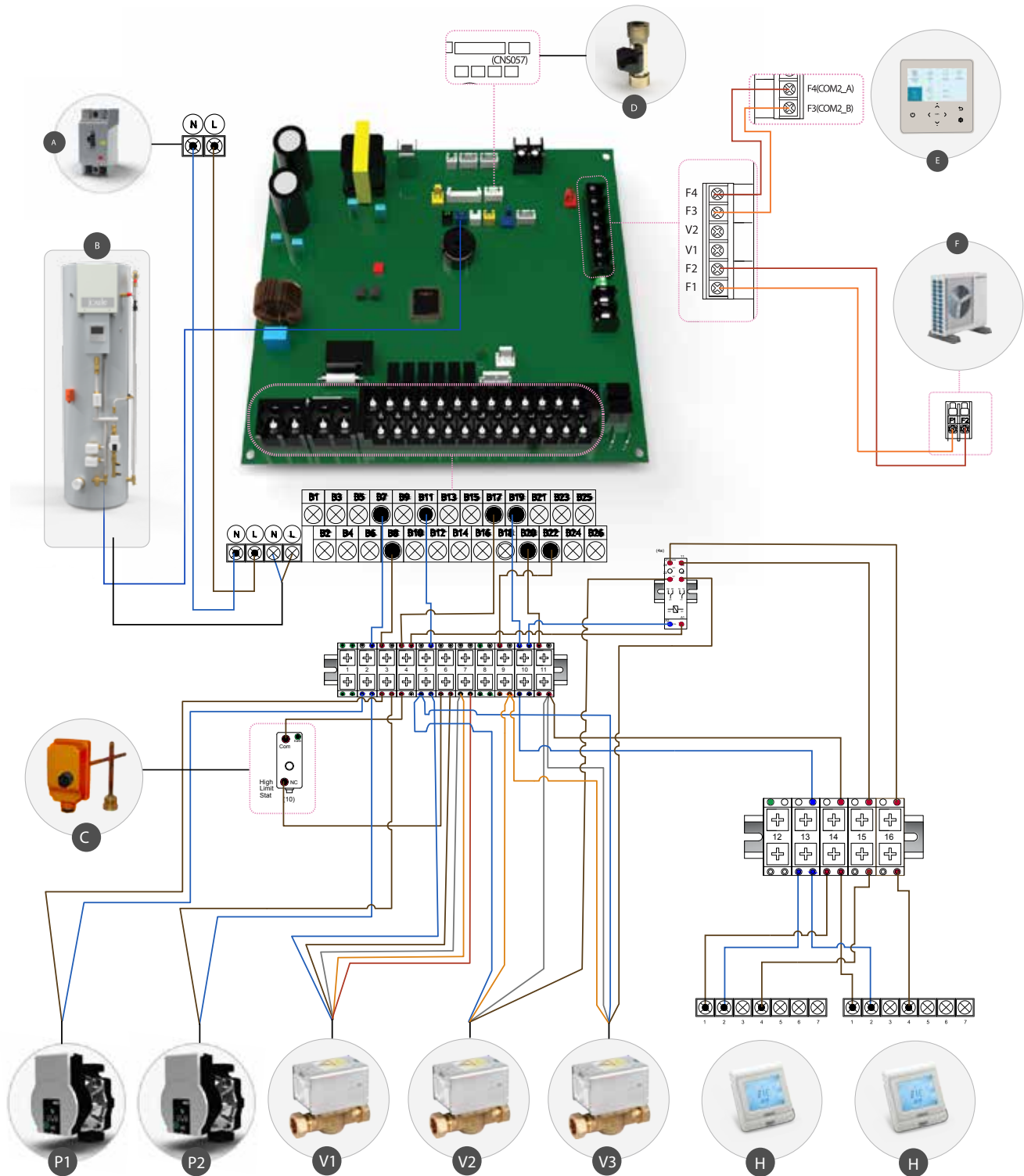
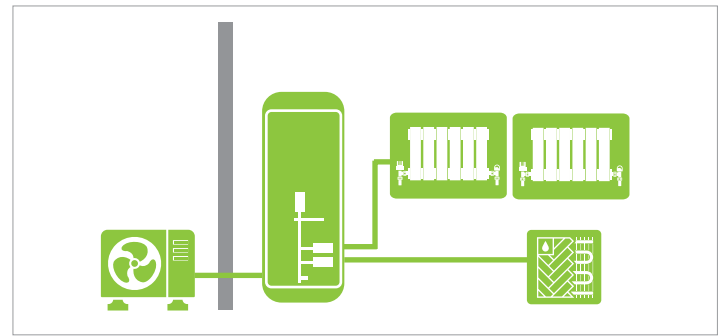

Joule Cylinders- Smart Plumb Pre-plumb Compact

Compact Pre-Plumbed Cylinder For Joule Samsung Monobloc Units

The new and innovative Smart Plumb Compact has been designed to not only look modern and minimise footprint for homeowners, but it also has been designed to benefit installers.

Having all main components easily accessible proves maintenance simple, as well as strategically assigning all valves to be part of one unit concludes everything being in a single place logically makes the job at hand simple, less time consuming and cost effective.

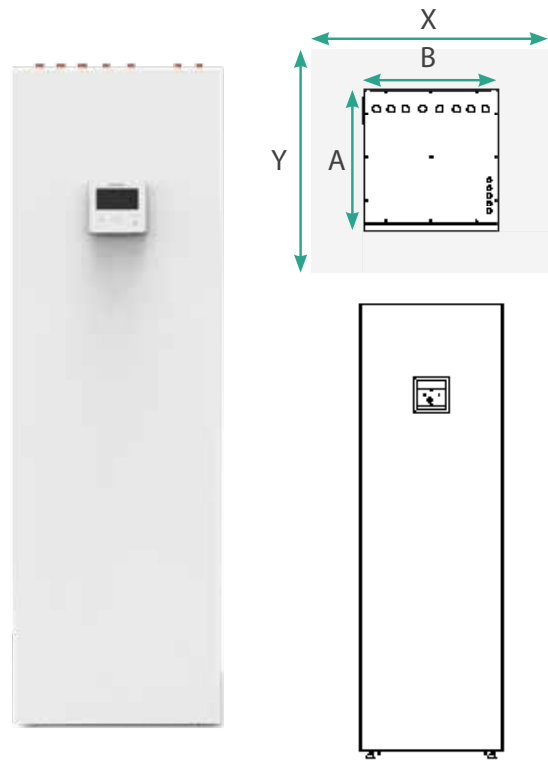

CYLINDER		HUGH-180COM-3C	HUGH-230COM-3C	
NOMINAL HOT WATER VOLUME (LITRES)		180L	230L	
HEAT PUMP COMBINATION HEATER - Large Profile (Average Climate) ErP Rating		C		
OPERATING AMBIENT TEMPERATURE (°C DB)		0 ~ +35°C (RH<80%)	0 ~ +35°C (RH<80%)	
SOUND PRESSURE LEVEL AT 1M (dBA)		28	28	
WATER	Primary Circuit Pump	willo- Yonos PARA RS 15		
	Sanitary Hot Water Pump			
	Connection Size (mm) Heating / DHW			28 / 22
WATER SAFETY DEVICES	Water Circuit	Control Thermistor (°C)	1 - 80	1 - 80
		Flow Sensor (minimum flow 7L/min)	Supplied	Supplied
	DHW Cylinder	Control Thermistor (°C)	75	75
		Temp and Pressure Relief Valve (°C)/ (MPa (Bar))	90 / 0.7 (7)	
DIMENSIONS (mm)	Width	595		
	Height	1900		
FOOTPRINT (mm)	Length (A)	620		
	Width (B)	595		
FREE FLOOR SPACE (mm)	Length (X)	595		
	Width (Y)	1020		
WEIGHT EMPTY / FULL (kg)		85/ 265	90/ 320	
ELECTRICAL DATA	Electrical Supply	220-240v, 50Hz		
	Phase	Single		
	Fuse Rating - MCB Sizes (A)*1	20		
	Immersion Capacity (kW)	3		
	Max Running Current (A)	16		
	Fuse Rating - MCB Sizes (A)*1	20		

Joule Cylinders - Compact Electrical Diagram

F	Samsung Outdoor Unit	V3	Heating Zone Valve 2
D	Flow Sensor	V4	Heating Zone Valve 1
P1	Primary Circulating Pump	E	Samsung Control Unit
P2	Heating Return Pump	B	Compact Pre Plumb Cylinder
V1	DHW Zone Valve	J	Joule MIM board
A	30A ELCB	C	Samsung MIM Board

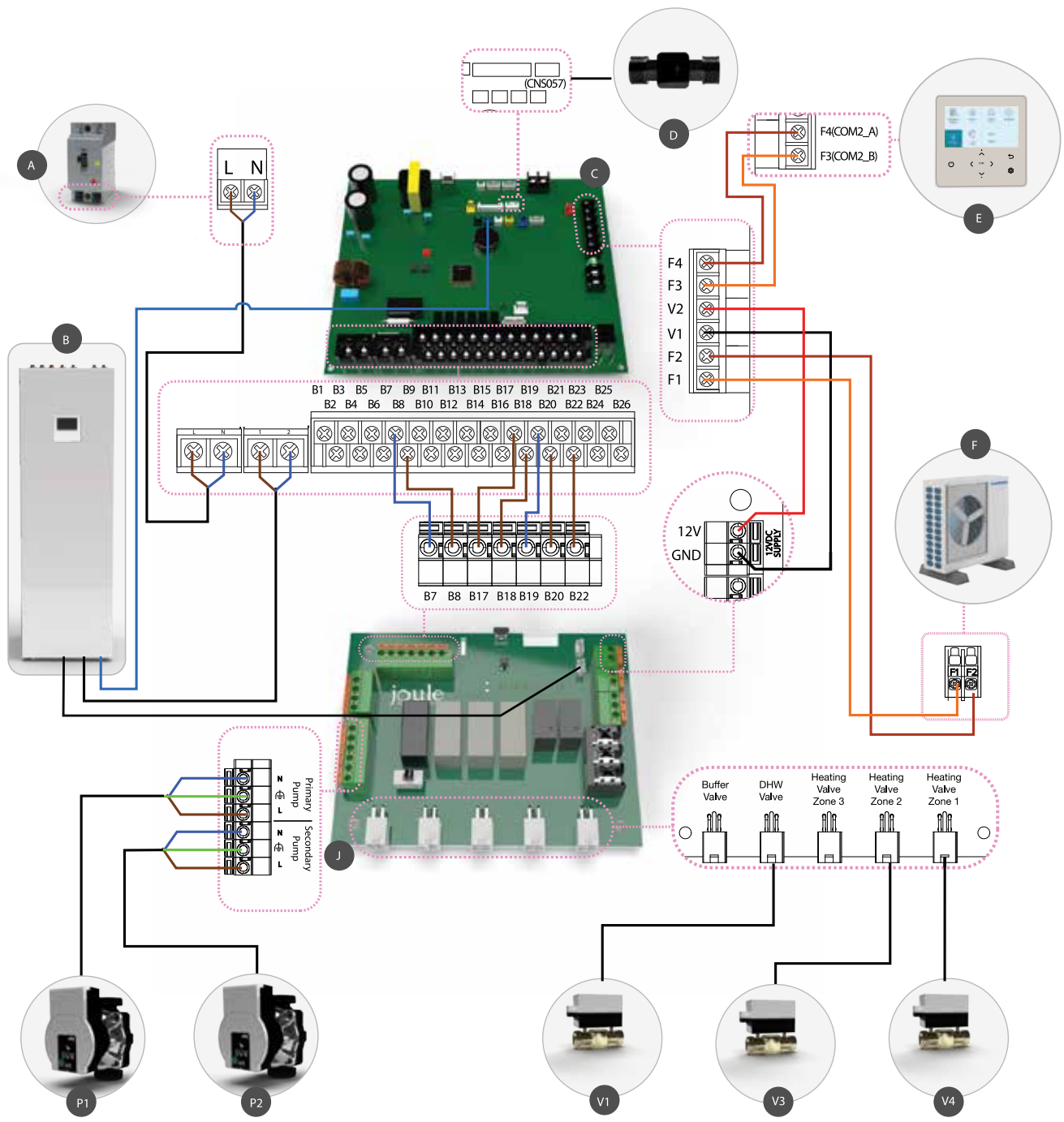
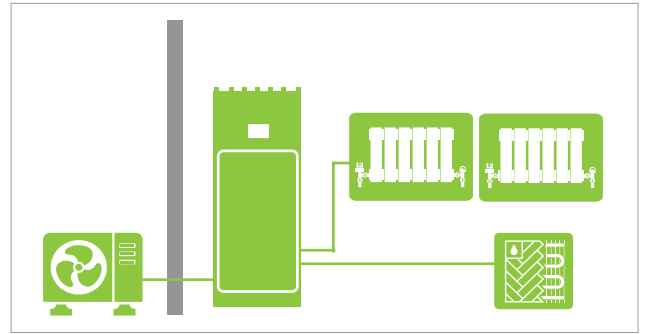

Joule Cylinders - Smart Plumb Pre-plumbed

Smart Plumb Pre-Plumbed Cylinder For Joule Samsung Monobloc Units

The Smart Plumb by Joule is the most efficient pre-plumbed solution for heat pump systems. The cylinder / buffer combo is pre-plumbed, wired and commissioned before it leaves the factory.

The buffer / low loss header acts as an intermediary vessel for the heating system which helps system flow rate and defrost cycling. With the cylinder sitting over the buffer tank the foot print has been greatly reduced. The control wires are all hidden behind the cable cover.

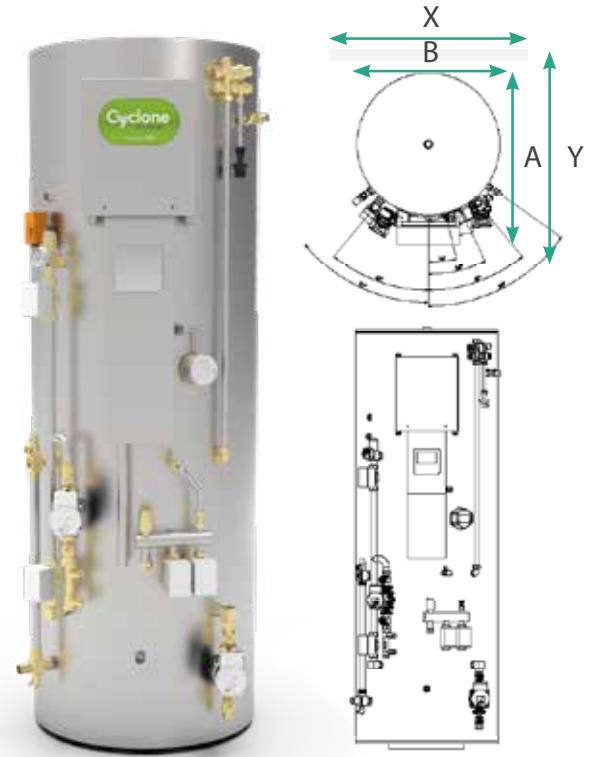

CYLINDER		HUGH-G61860-3C	HUGH-G62060-3C	HUGH-G62590-3C	HUGH-G63090-3C	HUGH-G63013-3C	HUGH-G64013-3C
NOMINAL HOT WATER VOLUME (LITRES)		180L/60L	200L/60L	250L/90L	300L/90L	300L/130L	400L/130L
ErP RATING		B/B	C/B	C/B	C/B	C/B	C/B
STANDING LOSS (W)		68	83	90	94	94	102
WATER	Primary Circuit Pump	Wilo - Yonos PARA RS 15					
	Heating Circuit Pump						
	Connection Size (mm) Heating / DHW						
WATER SAFETY	Water Circuit	Control Thermistor (°C)	80				
		DHW Expansion Vessel (Litres)	18				
		Control Thermistor (°C)	75				
		Over Temperature Cut-Out (°C)	80 ± 5				
		Temp and Pressure Relief Valve (°C) / (MPa (Bar))	90/0.7(7)				
		Expansion Relief Valve (Cold) (MPa (Bar))	0.6 (6)				
DIMENSIONS (mm)	Width	560		660		710	
	Height	1870	1980	1950		1850	2160
FOOTPRINT (mm)	Length (A)	740		800		910	
	Width (B)	740		800		910	
FREE FLOOR SPACE (mm)	Length (X)	1290		1350		1460	
	Width (Y)	840		900		1010	
WEIGHT EMPTY / FULL (kg)		78/ 318	83/ 343	92/ 432	96/ 451	101/ 491	113/ 643
CYLINDER MATERIAL	Cylinder	Cylinder Material					
	Insulation	Stainless Steel Duplex LDX 2101					
		Insulation Type					
		Polyurethane foam CFC-Free and HCFC Free					
		Insulation Thickness (mm)					
50							
GWP of Insulation							
3.1							
ODP of Insulation							
0							
ELECTRICAL DATA	Electrical Supply		220-240v, 50Hz				
	Phase		Single				
	Fuse Rating - MCB Sizes (A)*1		20				
	Immersion Capacity (kW)		3				
	Max Running Current (A)		16				

Joule Cylinders- Smart Plumb Pre Plumb Electrical Diagram

F	Samsung Outdoor Unit	V3	Heating Zone Valve 2
D	Flow Sensor	V4	Heating Zone Valve 1
P1	Primary Circulating Pump	E	Samsung Control Unit
P2	Heating Return Pump	B	Smart Plumb Pre Plumb Cylinder
V1	DHW Zone Valve	J	Joule MIM board
A	30A ELCB	C	Samsung MIM Board
V2	Buffer Valve		

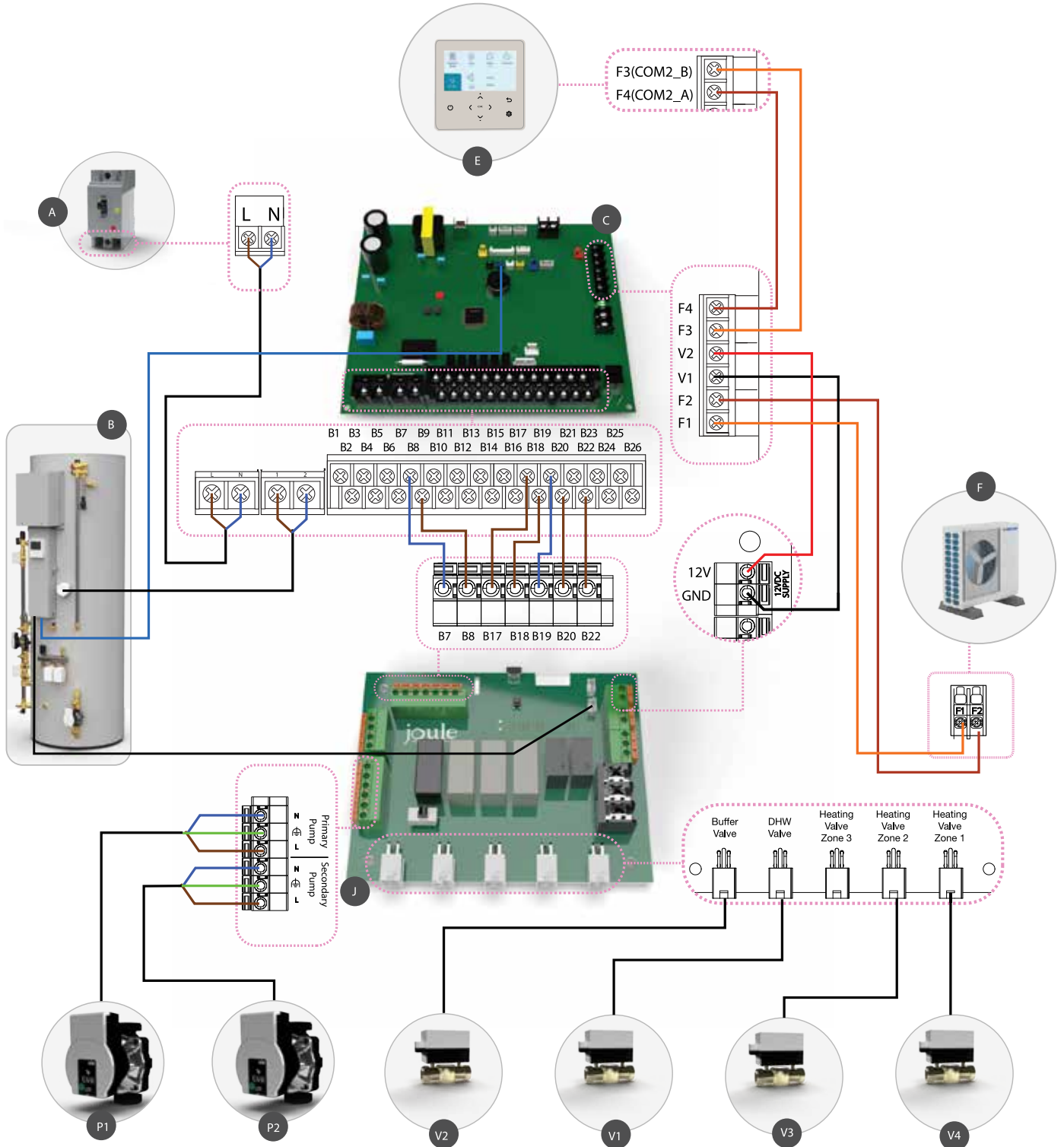
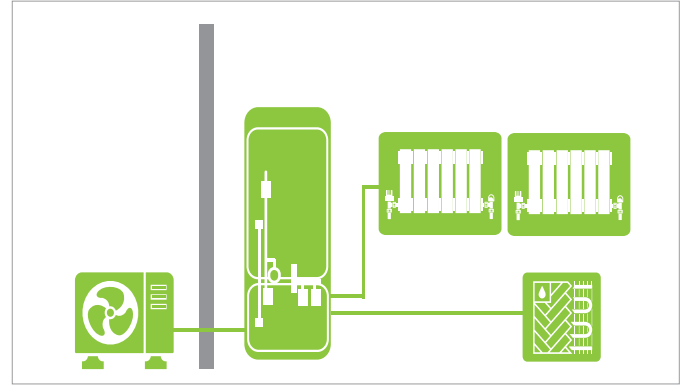

Joule Cylinders - Kodiak Pre Plumb

Standard KODIAK Pre-Plumbed Cylinder For Joule Samsung Monobloc Units

Our Kodiak is the most innovative pre-plumbed solution for heat pump systems. The next generation compact Pre-Plumbed pack is designed to control the distribution of heat to each zone. A unique, patented, modular zonal control manifold for heating and hot water systems.

Joule have optimised the layout of the preplumb developing a patented hydraulic design while also making it easier and faster to install the cylinder with improved access for the installer.

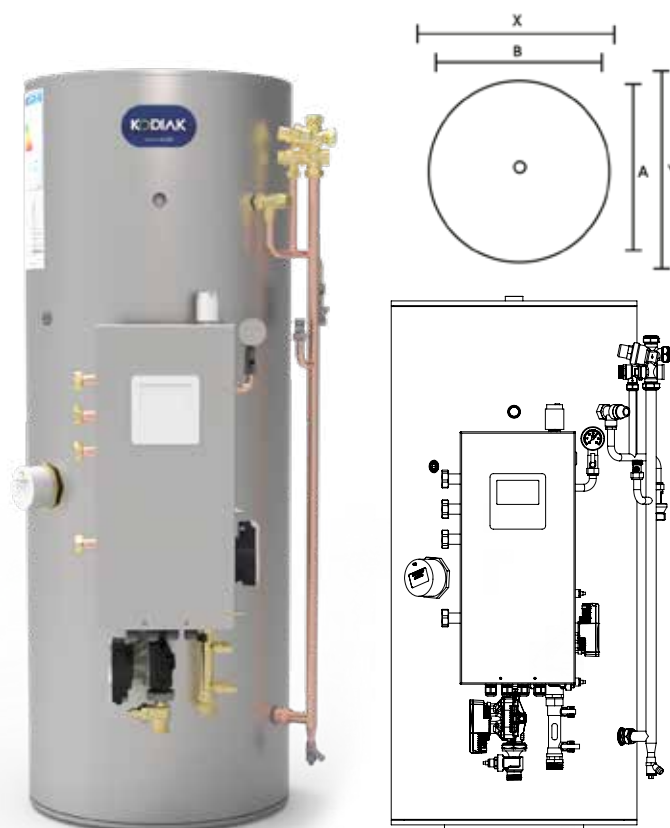

CYLINDER		HUKH-G6150-L3C	HUKH-G6170-L3C	HUKH-G6200-L3C	HUKH-G6250-L3C	HUKH-G6300-L3C	HUKH-G6150-S3C	HUKH-G6170-S3C	HUKH-G6200-S3C	
NOMINAL HOT WATER VOLUME (LITRES)		150	170	200	250	300	150	170	200	
ErP RATING		C	C	C	C	C	C	C	C	
STANDING LOSS (W)		55	66	81	89	92	70	79	84	
WATER		Primary Circuit Pump	Wilo - Yonos PARA RS 15							
		Heating Circuit Pump								
		Connection Size (mm) Heating / DHW								22mm
WATER SAFETY	Water Circuit	Control Thermistor (°C)	80							
		DHW Expansion Vessel (Litres)	18							
	DHW Cylinder	Control Thermistor (°C)	75							
		Over Temperature Cut-Out (°C)	80 ± 5							
		Temp and Pressure Relief Valve (°C) / (MPa (Bar))	90/0.7(7)							
		Expansion Relief Valve (Cold) (MPa (Bar))	0.6 (6)							
DIMENSIONS (mm)		Width	540	540	540	540	540	475	475	475
		Height	1190	1310	1490	1815	2040	1335	1535	1880
FOOTPRINT (mm)		Length (A)	740	740	800	800	910	640	640	700
		Width (B)	740	740	800	800	910	640	640	700
FREE FLOOR SPACE (mm)		Length (X)	1290	1290	1350	1350	1460	1920	1920	1920
		Width (Y)	840	840	900	900	1010	740	740	740
WEIGHT EMPTY / FULL (kg)		78/ 318	83/ 343	92/ 432	96/ 451	101/ 491	36/ 175	39/ 199	43/ 230	
CYLINDER MATERIAL		Cylinder	Stainless Steel Duplex LDX 2101							
		Insulation	Insulation Type	Polyurethane foam CFC-Free and HCFC Free						
			Insulation Thickness (mm)	50						
			GWP of Insulation	3.1						
			ODP of Insulation	0						
ELECTRICAL DATA		Electrical Supply	220-240v, 50Hz							
		Phase	Single							
		Fuse Rating - MCB Sizes (A)*1	20							
		Immersion Capacity (kW)	3							
		Max Running Current (A)	16							

Joule Cylinders - Kodiak Pre Plumb Electrical Diagram

F	Samsung Outdoor Unit	V3	Heating Zone Valve 2
D	Flow Sensor	V4	Heating Zone Valve 1
P1	Primary Circulating Pump	E	Samsung Control Unit
P2	Heating Return Pump	B	Compact Pre Plumb Cylinder
V1	DHW Zone Valve	J	Joule MIM board
A	30A ELCB	C	Samsung MIM Board

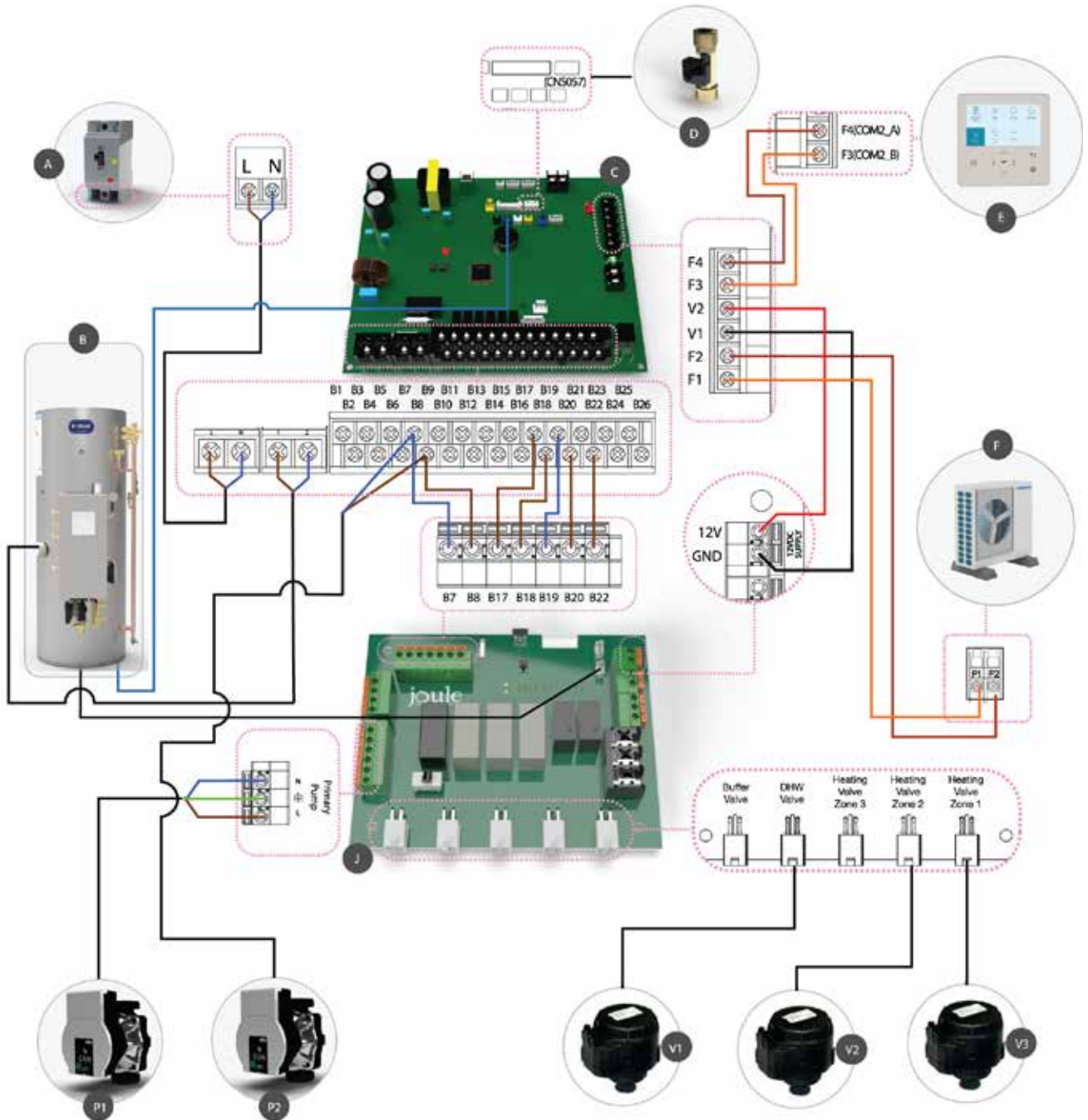
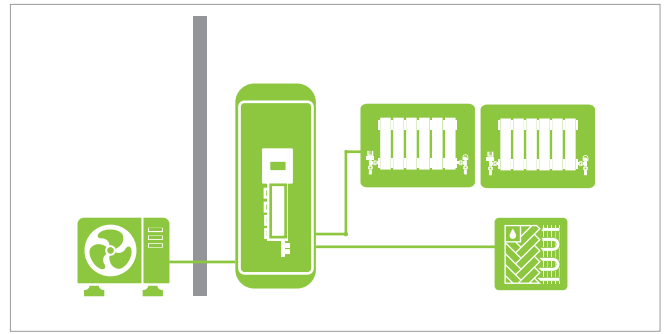

Joule Cyclinders - Unplumbed Cylinder

Standard Unplumbed Unvented Hot water Cylinder For Joule Samsung Monobloc Units

Joule hot water cylinders are state of the art in terms of manufacturing and quality when it comes to unvented hot water solutions. With its sleek design and pre-plumbed architecture, fitted with quality components and less space requirements for the pre-plumbed hot water cylinder have been reduced dramatically.

Our slimline models have been designed for the use in tight areas where there is more height than width available.



CYLINDER		TCIMVH-0150LFB	TCIMVH-0170LFB	TCIMVH-0200LFC	TCIMVH-0250LFC	TCIMVH-0300LFC	TCIMVH-0150SFB	TCIMVH-0170SFB	TCIMVH-0200SFC	
NOMINAL HOT WATER VOLUME (LITRES)		150	170	200	250	300	150	170	200	
ErP RATING		C	C	C	C	D	C	C	C	
STANDING LOSS (W)		132	190	194	214	247	168	190	202	
WATER	Primary Circuit Pump	N/A								
	Heating Circuit Pump	N/A								
	Connection Size (mm) Heating / DHW	28mm								
WATER SAFETY	Water Circuit	Control Thermistor (°C)								
	DHW Cylinder	DHW Expansion Vessel (Litres)	12L	19L			24L	12L	19L	
		Control Thermistor (°C)	75							
		Over Temperature Cut-Out (°C)	80 ± 5							
		Temp and Pressure Relief Valve (°C) / (MPa) (Bar)	90/0.7(7)							
		Expansion Relief Valve (Cold) (MPa) (Bar)	0.6 (6)							
DIMENSIONS (mm)	Width	540	540	540	540	540	475	475	475	
	Height	1190	1310	1490	1815	2040	1335	1535	1880	
FOOTPRINT (mm)	Length (A)	740	740	800	800	910	640	640	700	
	Width (B)	740	740	800	800	910	640	640	700	
FREE FLOOR SPACE (mm)	Length (X)	1290	1290	1350	1350	1460	1920	1920	1920	
	Width (Y)	840	840	900	900	1010	740	740	740	
WEIGHT EMPTY / FULL (kg)		78/ 318	83/ 343	92/ 432	96/ 451	101/ 491	36/ 175	39/ 199	43/ 230	
CYLINDER MATERIAL	Cylinder	Stainless Steel Duplex LDX 2101								
	Insulation	Insulation Type	Polyurethane foam CFC-Free and HCFC Free							
		Insulation Thickness (mm)	50							
		GWP of Insulation	3.1							
		ODP of Insulation	0							
ELECTRICAL DATA	Electrical Supply	220-240v, 50Hz								
	Phase	Single								
	Fuse Rating - MCB Sizes (A)*1	20								
	Immersion Capacity (kW)	3								
	Max Running Current (A)	16								

Joule Cylinders - Unplumbed Cylinder Electrical Diagram

F	Samsung Outdoor Unit	V2	Heating Zone Valve 1
D	Flow Sensor	V3	Heating Zone Valve 2
P1	Primary Circulating Pump	E	Samsung Control Unit
P2	Heating Return Pump	C	High Limit Stat
V1	DHW Zone Valve	B	Standard Unplumbed Cylinder
A	30A ELCB	H	Joule Room Thermostat

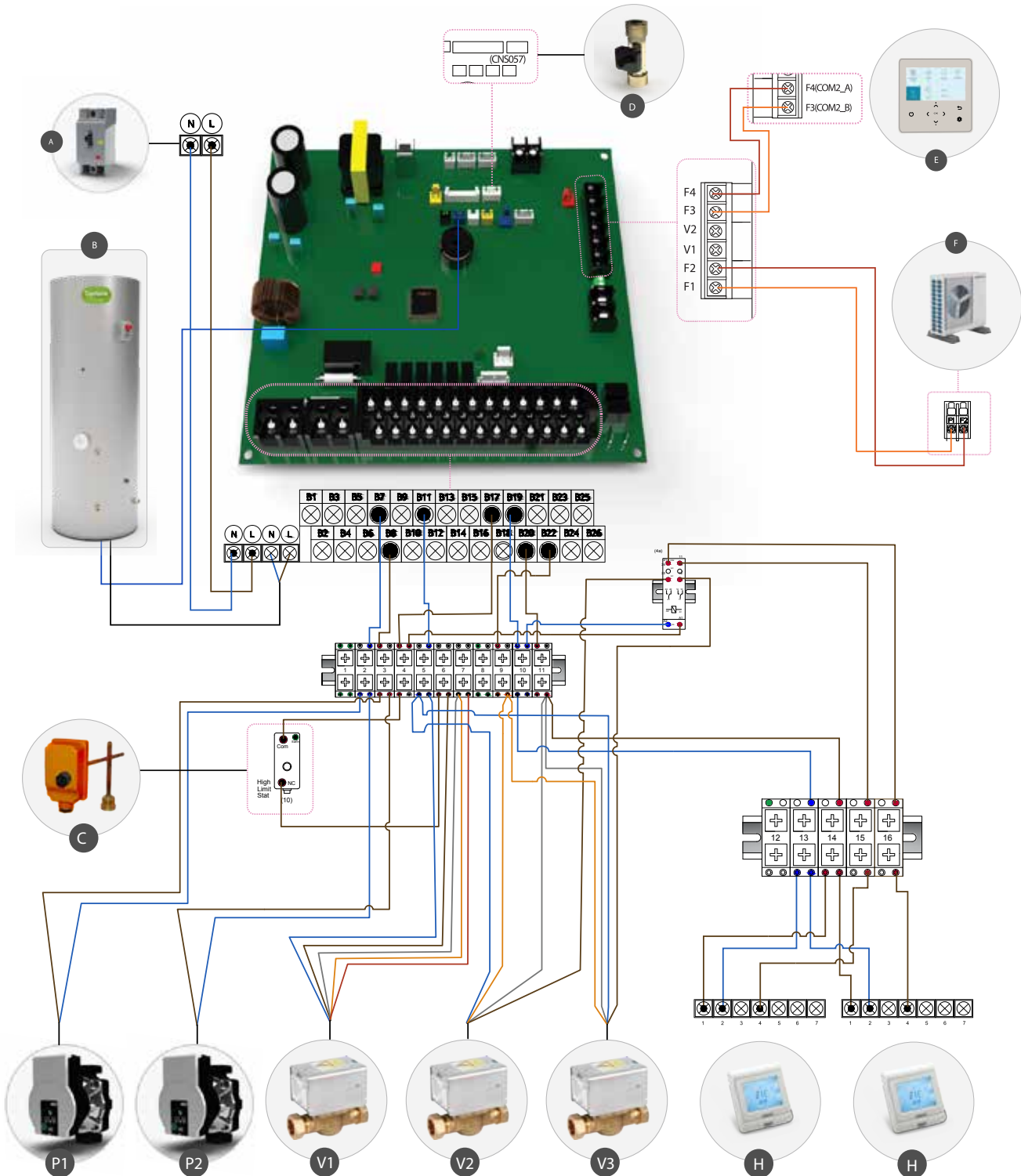
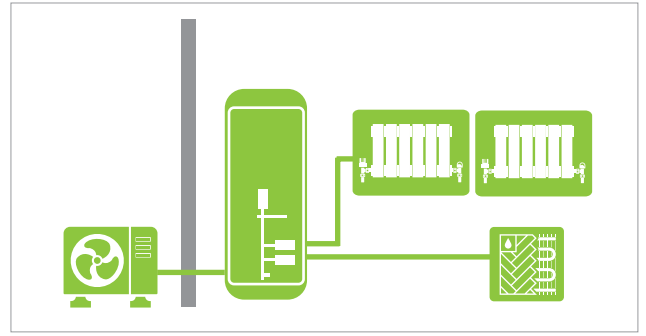



Joule Air Source Heat Pumps - Package Prices





5kW Monobloc Air Source Heat Pump - HHSM-G600005-1



Whats Included

	Item Code	Item Code Description
	HZK-0Y-000001F	1"Y PATTERN STRAINER WITH ISOLATION
	HZK-0V-0000028	28mm Iso Valve Red
	HZK-0H28-0.075	Braided Hose 28mm 0.75m Ins Elbow (2 in a box)

Recommended Components

	Item Code	Item Code Description	Price (£)
	HZK-0K-0000000	ANTI-VIBRATION FIX-IT FOOT 600MM KIT	£40.42
	HZK-0C-0000020	20L CONCENTRATE HP FLUID	£73.26
	HMPYK-0000012	12L Robokit sealed system Kit + Br	£60.13
	TZC-5-ESILPROG	Programmable LED Room Thermostat - P5	£63.16

SYSTEM PRICE

Item Code	Item Code Description	Price (£)
Kodiak Pre Plumb		
HXSM-G6-K211	SAMSUNG KODIAK 5 - 4.35KW 1PH 150L STANDARD	£4,589.70
HXSM-G6-K212	SAMSUNG KODIAK 5 - 4.35KW 1PH 170L STANDARD	£4,712.88
HXSM-G6-K213	SAMSUNG KODIAK 5 - 4.35KW 1PH 200L STANDARD	£4,781.74
HXSM-G6-K201	SAMSUNG KODIAK 5 - 4.35KW 1PH 150L SLIMLINE	£4,774.47
HXSM-G6-K202	SAMSUNG KODIAK 5 - 4.35KW 1PH 170L SLIMLINE	£4,815.54

SYSTEM PRICE

Item Code	Item Code Description	Price (£)
Standard Pre Plumb		
HXSM-G6-031	SAMSUNG MONO 5 - 4.35KW 1PH 150L STANDARD	£5,282.71
HXSM-G6-032	SAMSUNG MONO 5 - 4.35KW 1PH 170L STANDARD	£5,356.77
HXSM-G6-033	SAMSUNG MONO 5 - 4.35KW 1PH 200L STANDARD	£5,429.46
HXSM-G6-021	SAMSUNG MONO 5 - 4.35KW 1PH 150L SLIMLINE	£5,282.71
HXSM-G6-022	SAMSUNG MONO 5 - 4.35KW 1PH 170L SLIMLINE	£5,356.77
HXSM-G6-065	SAMSUNG MONO 5 - 4.35KW 1PH 200L SOLAR	£5,652.95
HXSM-G6-066	SAMSUNG MONO 5 - 4.35KW 1PH 250L SOLAR	£5,796.17

SYSTEM PRICE

Item Code	Item Code Description	Price (£)
Smart Plumb - Buffer		
HXSM-G6-093	SAMSUNG MONO 5 - 4.35KW 1PH JOULE HP MONO 180/60L	£6,472.53
HXSM-G6-094	SAMSUNG MONO 5 - 4.35KW 1PH JOULE HP MONO 200/60L	£6,316.22

Joule Air Source Heat Pumps - Package Prices

8kW Monobloc Air Source Heat Pump - HHSM-G600008-1



Whats Included

	Item Code	Item Code Description
	HZK-0Y-000001F	1"Y PATTERN STRAINER WITH ISOLATION
	HZK-0V-0000028	28mm Iso Valve Red
	HZK-0H28-0.075	Braided Hose 28mm 0.75m Ins Elbow (2 in a box)

Recommended Components

	Item Code	Item Code Description	Price (£)
	HZK-0K-0000000	ANTI-VIBRATION FIX-IT FOOT 600MM KIT	£40.42
	HZK-0C-0000020	20L CONCENTRATE HP FLUID	£73.26
	HMPYK-0000012	12L Robokit sealed system Kit + Br	£60.13
	TZC-5-ESILPROG	Programmable LED Room Thermostat - P5	£63.16

SYSTEM PRICE

Item Code	Item Code Description	Price (£)
Kodiak Pre Plumb		
HXSM-G6-K215	SAMSUNG KODIAK 8 - 6.37KW 1PH 150L STANDARD	£4,998.49
HXSM-G6-K216	SAMSUNG KODIAK 8 - 6.37KW 1PH 170L STANDARD	£5,121.67
HXSM-G6-K217	SAMSUNG KODIAK 8 - 6.37KW 1PH 200L STANDARD	£5,190.53
HXSM-G6-K218	SAMSUNG KODIAK 8 - 6.37KW 1PH 250L STANDARD	£5,306.46
HXSM-G6-K205	SAMSUNG KODIAK 8 - 6.37KW 1PH 150L SLIMLINE	£5,183.26
HXSM-G6-K206	SAMSUNG KODIAK 8 - 6.37KW 1PH 170L SLIMLINE	£5,224.34

SYSTEM PRICE

Item Code	Item Code Description	Price (£)
Standard Pre Plumb		
HXSM-G6-034	SAMSUNG MONO 8 - 6.37KW 1PH 150L STANDARD	£5,926.23
HXSM-G6-035	SAMSUNG MONO 8 - 6.37KW 1PH 170L STANDARD	£6,000.27
HXSM-G6-036	SAMSUNG MONO 8 - 6.37KW 1PH 200L STANDARD	£6,072.97
HXSM-G6-037	SAMSUNG MONO 8 - 6.37KW 1PH 250L STANDARD	£6,166.99
HXSM-G6-023	SAMSUNG MONO 8 - 6.37KW 1PH 150L SLIMLINE	£5,926.23
HXSM-G6-024	SAMSUNG MONO 8 - 6.37KW 1PH 170L SLIMLINE	£6,000.27
HXSM-G6-067	SAMSUNG MONO 8 - 6.37KW 1PH 210L SOLAR	£6,296.44
HXSM-G6-068	SAMSUNG MONO 8 - 6.37KW 1PH 250L SOLAR	£6,699.53
HXSM-G6-069	SAMSUNG MONO 8 - 6.37KW 1PH 300L SOLAR	£7,183.21

SYSTEM PRICE

Item Code	Item Code Description	Price (£)
Smart Plumb - Buffer		
HXSM-G6-095	SAMSUNG MONO 8 - 6.37KW 1PH JOULE HP MONO 180/60L	£6,887.03
HXSM-G6-096	SAMSUNG MONO 8 - 6.37KW 1PH JOULE HP MONO 200/60L	£6,959.73
HXSM-G6-097	SAMSUNG MONO 8 - 6.37KW 1PH JOULE HP MONO 250/90L	£7,053.75
HXSM-G6-123	SAMSUNG MONO 8 - 6.37KW 1PH JOULE HP MONO 300/130L	£8,069.49

Joule Air Source Heat Pumps - Package Prices

12kW Monobloc Air Source Heat Pump - HHSM-G6000012-1



Whats Included		
	Item Code	Item Code Description
	HZK-0Y-000001F	1" Y PATTERN STRAINER WITH ISOLATION
	HZK-0V-0000028	28mm Iso Valve Red
	HZK-0H28-0.075	Braided Hose 28mm 0.75m Ins Elbow (2 in a box)

Recommended Components			
	Item Code	Item Code Description	Price (£)
	HZK-0K-0000000	ANTI-VIBRATION FIX-IT FOOT 600MM KIT	£40.42
	HZK-0C-0000020	20L CONCENTRATE HP FLUID	£73.26
	HMPYK-0000012	12L Robokit sealed system Kit + Br	£60.13
	TZC-5-ESILPROG	Programmable LED Room Thermostat - P5	£63.16

	SYSTEM PRICE		Price (£)
	Item Code	Item Code Description	
Kodiak Pre Plumb			
	HXSM-G6-K219	SAMSUNG KODIAK 12 - 10.43KW 1PH 170L STANDARD	£6,350.39
	HXSM-G6-K220	SAMSUNG KODIAK 12 - 10.43KW 1PH 210L STANDARD	£6,419.25
	HXSM-G6-K221	SAMSUNG KODIAK 12 - 10.43KW 1PH 250L STANDARD	£6,535.18
	HXSM-G6-K222	SAMSUNG KODIAK 12 - 10.43KW 1PH 300L STANDARD	£6,545.43
	HXSM-G6-K209	SAMSUNG KODIAK 12 - 10.43KW 1PH 170L SLIMLINE	£6,453.06

	SYSTEM PRICE		Price (£)
	Item Code	Item Code Description	
Standard Pre Plumb			
	HXSM-G6-038	SAMSUNG MONO 12 - 10.43KW 1PH 170L STANDARD	£7,115.83
	HXSM-G6-039	SAMSUNG MONO 12 - 10.43KW 1PH 200L STANDARD	£7,164.80
	HXSM-G6-040	SAMSUNG MONO 12 - 10.43KW 1PH 250L STANDARD	£7,312.87
	HXSM-G6-041	SAMSUNG MONO 12 - 10.43KW 1PH 300L STANDARD	£7,536.35
	HXSM-G6-025	SAMSUNG MONO 12 - 10.43KW 1PH 170L SLIMLINE	£7,353.96
	HXSM-G6-070	SAMSUNG MONO 12 - 10.43KW 1PH 200L SOLAR	£7,388.27
	HXSM-G6-071	SAMSUNG MONO 12 - 10.43KW 1PH 250L SOLAR	£7,536.35
	HXSM-G6-072	SAMSUNG MONO 12 - 10.43KW 1PH 300L SOLAR	£7,759.83



	SYSTEM PRICE		Price (£)
	Item Code	Item Code Description	
Smart Plumb - Buffer			
	HXSM-G6-098	SAMSUNG MONO 12 - 10.43KW 1PH JOULE HP MONO 180/60	£8,672.16
	HXSM-G6-099	SAMSUNG MONO 12 - 10.43KW 1PH JOULE HP MONO 200/60	£9,167.62
	HXSM-G6-100	SAMSUNG MONO 12 - 10.43KW 1PH JOULE HP MONO 250/90	£9,229.69
	HXSM-G6-101	SAMSUNG MONO 12 - 10.43KW 1PH JOULE HP MONO 300/13	£9,874.17
	HXSM-G6-124	SAMSUNG MONO 12 - 10.43KW 1PH JOULE HP MONO 400/13	£10,196.63

Joule Air Source Heat Pumps - Package Prices





16kW Monobloc Air Source Heat Pump - HHSM-G6000016-1



Whats Included

	Item Code	item Code Description
	HZK-0Y-000001F	1"Y PATTERN STRAINER WITH ISOLATION
	HZK-0V-0000028	28mm Iso Valve Red
	HZK-0H28-0.075	Braided Hose 28mm 0.75m Ins Elbow (2 in a box)

Recommended Components

	Item Code	item Code Description	Price (£)
	HZK-0K-0000000	ANTI-VIBRATION FIX-IT FOOT 600MM KIT	£40.42
	HZK-0C-0000020	20L CONCENTRATE HP FLUID	£73.26
	HMPYK-0000012	12L Robokit sealed system Kit + Br	£60.13
	TZC-5-ESILPROG	Programmable LED Room Thermostat - P5	£63.16

SYSTEM PRICE

Item Code	Item Code Description	Price (£)
Standard Pre Plumb		
HXSM-G6-042	SAMSUNG MONO 16 - 12.28KW 1PH 200L STANDARD	£8,507.00
HXSM-G6-043	SAMSUNG MONO 16 - 12.28KW 1PH 250L STANDARD	£8,655.10
HXSM-G6-044	SAMSUNG MONO 16 - 12.28KW 1PH 300L STANDARD	£8,878.57
HXSM-G6-073	SAMSUNG MONO 16 - 12.28KW 1PH 200L SOLAR	£8,730.49
HXSM-G6-074	SAMSUNG MONO 16 - 12.28KW 1PH 250L SOLAR	£8,878.57
HXSM-G6-075	SAMSUNG MONO 16 - 12.28KW 1PH 300L SOLAR	£9,102.06

SYSTEM PRICE

Item Code	Item Code Description	Price (£)
Smart Plumb - Buffer		
HXSM-G6-102	SAMSUNG MONO 16 - 12.28KW 1PH JOULE HP MONO 200/60	£9,393.76
HXSM-G6-103	SAMSUNG MONO 16 - 12.28KW 1PH JOULE HP MONO 250/90	£9,541.85
HXSM-G6-104	SAMSUNG MONO 16 - 12.28KW 1PH JOULE HP MONO 300/13	£11,216.38
HXSM-G6-125	SAMSUNG MONO 16 - 12.28KW 1PH JOULE HP MONO 400/13	£11,538.85

Outdoor Unit

Item Code	Description	Price (£)
HHSM-G600005-1	MONO 5 - 4.35KW R32 ASHP OUTDOOR UNIT STD	£2,254.39
HHSM-G600008-1	MONO 8 - 6.37KW R32 ASHP OUTDOOR UNIT STD	£2,658.78
HHSM-G600012-1	MONO 12 - 10.43KW R32 ASHP OUTDOOR UNIT STD	£3,874.30
HHSM-G600016-1	MONO 16 - 12.28KW R32 ASHP OUTDOOR UNIT STD	£4,301.93
HHSA-G60005-01	MONO 5 - 4.35KW R32 ASHP OUTDOOR UNIT COASTAL	£2,505.26
HHSA-G60009-01	MONO 8 - 6.37KW R32 ASHP OUTDOOR UNIT COASTAL	£3,558.58
HHSA-G60012-01	MONO 12 - 10.43KW R32 ASHP OUTDOOR UNIT COASTAL	£4,194.31
HHSA-G60016-01	MONO 16 - 12.28KW R32 ASHP OUTDOOR UNIT COASTAL	£5,496.95











Controller

Item Code	Description	Price (£)
 HZSMC-G6000000	MONO CONTROL CENTRE (MIM-E03CN) - GEN 6	£588.00





Electrical

Item Code	Description	Price (£)
PZI-A-00000000	Pv Ac Isolator	£37.40
HZSMC-MIMH04EN	Samsung Wi-Fi Receiver 2.0 (Ehs) (Mim-H04en)	£145.85
HZU-ELEC-MET	Emlite A100c Single Phase Kwh Meter - Mcs	£44.88

Mechanical

Item Code	Description	Price (£)
 HZK-OC-0000020	20l Concentrate Hp Fluid	£73.26
 HZK-0H28-0.075	Insulated Flex Conn Pipes (28mm X 300mm) Elbow	£95.72
 HZK-0K-0000000	Anti-Vibration Fix-It Foot 600mm Kit	£40.42
 HZK-0Y-000001F	1"Y Pattern Strainer With Isolation	£22.58
 HZK-0P-0000000	Combined Fill Flush + Flow Met	£69.81
 HMPYK-00000012	12l Robokit Sealed System Kit + Br	£60.13
 HMPYK-00000018	18l Robokit Sealed System Kit + Br	£132.18
 HMPYK-00000024	24l Robokit Sealed System Kit + Br	£134.66
 HZK-0D-0000000	Heat Pump Wall Drip Tray (1100x400)	£204.60
 HZK-0J-0000000	Heat Pump Wall Bracket (Pair)	£272.61
 HZK-0V-0000028	28mm Iso Valve Red	£16.23

Indoor Unit

Item Code	Description		Price (£)	
Unplumbed				
TCIMVH-0150LFB	150L IND HG STANDARD B		£983.32	
TCIMVH-0170LFB	170L IND HG STANDARD C		£1,028.58	
TCIMVH-0200LFC	200L IND HG STANDARD C		£1,062.41	
TCIMVH-0250LFC	250L IND HG STANDARD C		£1,268.01	
TCIMVH-0150SFB	150L IND HG SLIM B		£1,146.94	
TCIMVH-0170SFB	170L IND HG SLIM B		£1,174.22	
TCIMVH-0200SFC	200L IND HG SLIM C		£1,259.72	
TCIMVH-0200NFC	200L IND HG SHORT C		£1,062.41	
TCIMVH-0250NFC	250L IND HG SHORT C		£1,268.01	
TCIMVH-0300LFC	300L IND HG TALL C		£1,284.14	
Standard				
HUGH-G6150-L3C	150L R32 1PH HP PRE-PLUMBED STANDARD		£2,763.57	
HUGH-G6170-L3C	170L R32 1PH HP PRE-PLUMBED STANDARD		£2,832.13	
HUGH-G6200-L3C	200L R32 1PH HP PRE-PLUMBED STANDARD		£2,899.45	
HUGH-G6250-N3C	250L R32 1PH HP PRE-PLUMBED STANDARD		£3,036.56	
HUGH-G6300-N3C	300L R32 1PH HP PRE-PLUMBED STANDARD		£3,243.48	
HUGH-G6150-S3C	150L R32 1PH HP PRE-PLUMBED SLIMLINE		£2,763.57	
HUGH-G6170-S3C	170L R32 1PH HP PRE-PLUMBED SLIMLINE		£2,832.13	
Solar				
HUGS-G6200-L3C	200L R32 1PH HP PRE-PLUMBED SOLAR		£3,106.37	
HUGS-G6250-N3C	250L R32 1PH HP PRE-PLUMBED SOLAR		£3,243.48	
HUGS-G6300-N3C	300L R32 1PH HP PRE-PLUMBED SOLAR		£3,450.41	
Buffer				
HUGH-G61860-3C	180/60 R32 1PH HP PRE-PLUMBED CYL BUFF		£3,243.48	
HUGH-G62060-3C	200/60 R32 1PH HP PRE-PLUMBED CYL BUFF		£3,517.72	
HUGH-G62090-3C	200/90 R32 1PH HP PRE-PLUMBED CYL BUFF		£3,585.04	
HUGH-G62590-3C	250/90 R32 1PH HP PRE-PLUMBED CYL BUFF		£3,772.02	
HUGH-G63013-3C	300/130 R32 1PH HP PRE-PLUMBED CYL BUFF		£3,722.15	
HUGH-G64013-3C	400/130 R32 1PH HP PRE-PLUMBED CYL BUFF		£5,050.97	
HUGH-G61860-4C	180/60 R32 1PH HP PRE-PLUMBED CYL BUFF 3Z		£5,173.13	
HUGH-G62060-4C	200/60 R32 1PH HP PRE-PLUMBED CYL BUFF 3Z		£3,745.84	
HUGH-G62090-4C	200/90 R32 1PH HP PRE-PLUMBED CYL BUFF 3Z		£3,813.15	
HUGH-G62590-4C	250/90 R32 1PH HP PRE-PLUMBED CYL BUFF 3Z		£4,000.13	
HUGH-G63013-4C	300/130 R32 1PH HP PRE-PLUMBED CYL BUFF 3Z		£5,279.08	
HUGH-G64013-4C	400/130 R32 1PH HP PRE-PLUMBED CYL BUFF 3Z		£5,401.24	
Kodiak				
HUKH-G6150-L3C	150L IND STANDARD KODIAK PP HG 3Z G6			£2,176.29
HUKH-G6170-L3C	170L IND STANDARD KODIAK PP HG 3Z G6	£2,299.46		
HUKH-G6200-L3C	200L IND STANDARD KODIAK PP HG 3Z G6	£2,368.32		
HUKH-G6250-L3C	250L IND STANDARD KODIAK PP HG 3Z G6	£2,484.25		
HUKH-G6300-N3C	300L IND STANDARD KODIAK PP HG 3Z G6	£2,494.51		
HUKH-G6150-S3C	150L IND SLIM KODIAK PP HG 3Z G6	£2,361.06		
HUKH-G6170-S3C	170L IND SLIM KODIAK PP HG 3Z G6	£2,402.13		
HUKH-G6200-S3C	200L IND SLIM KODIAK PP HG 3Z G6	£2,463.73		

JOULE HIGH EFFICIENCY SOLAR THERMAL SYSTEMS



Mounting Angle  15-50°

Flat Roof Frame Opt. 

Multiple Mounting 

Remote Controlling 

What Is a Solar Thermal Panel?

While solar PV panels use the energy from the sun to generate electricity, solar thermal panels use the sun to heat up water. As such, solar PV panels and solar thermals are two very different technologies.

Solar thermal uses free renewable energy from the sun which, just like the solar PV panels, will help you save money and reduce your carbon footprint.



Compatible with renewable energy sources.



Reduce Carbon Footprint



Improve Home Efficiency



Lower running temperatures for reduced energy bills.

Spot In The Sun



Just like solar PV panels, a solar thermal system needs the sun as the main energy source. Therefore, the optimal position to be situated is somewhere with direct sunlight for the most part of the day.

However, they don't necessarily need to be placed on a roof. Other possible places could be on a flat roof or hang from a wall, as long as it gets direct sunlight.

Renewable Energy Source



The most important benefit is that solar energy is a 100% renewable energy source. We will always have solar energy.

Low Maintenance



Solar thermal panels require little maintenance and only occasional planned servicing. You only have to keep them relatively clean.

IMPORTANT NOTICE

A solar thermal system requires a dedicated solar cylinder. If you don't own a solar cylinder, the existing cylinder is replaced or a dedicated cylinder with a solar heating coil is added.

Acapella Evacuated Tube System



CERTIFIED

TECHNICAL DATA	10 Tube	20 Tube	30 Tube
Certification Number	INT ST21013/2	INT ST21013/3	INT ST21013/5
Gross Area	1.72m ²	3.38m ²	4.901m ²
Aperature area	0.93m ²	1.86m ²	2.791m ²
Absorber Area	0.8m ²	1.61m ²	2.411m ²
Length of Tube	1.8m	1.8m	1.8m
Dist. Between Tubes/Panels	0.078m	0.078m	0.078m
Weight	52kg	85kg	106kg
Max Operating Pressure	6bar	6bar	6bar
Recommended Operating Pressure	2-3bar	2-3bar	2-3bar
Recommended Flow Rate	0.5l/min/m ²	0.5l/min/m ²	0.5l/min/m ²
Fluid Volume in Collector	0.81l	1.65l	2.3l
Rated Heat Output	0.60kW	1.21kW	1.81kW
Absorber	Aluminium		
Coating	Aluminium Nitrate		
Absorbance	> 94%		
Emissivity	<7%		
Mounting Frame	Aluminium Nitrate		
Glass	Borosilicate Glass		
Mounting Inclination	15°-75°		
Inlet Outlet Dimensions	3 ¼ bracket male		
Stagnation Temperature	200.3°C		
Insulation Material	Mineral Wool + Polyurethane		
Heat Transfer Fluid	Glycol Mix		
Dimensions L X W X D (M)	2.01m x 0.854m x 0.189m	2.01m x 1.68m x 0.189m	2.01m x 2.42m x 0.189m

SYSTEM PRICE

Item Number	Item Description	Roof Dimensions	Recomended Cylinder Size	Price (£)
W x L x H (mm)				
SX-E-000000020-T	20 TUBE SOLAR SYSTEM - TILE	1680 x 2010 x 189	210L	£1,836.86
SX-E-000000020-S	20 TUBE SOLAR SYSTEM - SLATE	1680 x 2010 x 189	210L	£1,836.86
SX-E-000000020-B	20 TUBE SOLAR SYSTEM - BOLT	1680 x 2010 x 189	210L	£1,836.86
SX-E-000000030-T	30 TUBE SOLAR SYSTEM - TILE	2420 x 2010 x 189	250L	£2,253.34
SX-E-000000030-S	30 TUBE SOLAR SYSTEM - SLATE	2420 x 2010 x 189	250L	£2,253.34
SX-E-000000030-B	30 TUBE SOLAR SYSTEM - BOLT	2420 x 2010 x 189	250L	£2,253.34
SX-E-000000040-T	40 TUBE SOLAR SYSTEM - TILE	3460 x 2010 x 189	300L	£2,846.42
SX-E-000000040-S	40 TUBE SOLAR SYSTEM - SLATE	3460 x 2010 x 189	300L	£2,846.42
SX-E-000000040-B	40 TUBE SOLAR SYSTEM - BOLT	3460 x 2010 x 189	300L	£2,846.42

COMPONENTS INCLUDED

Item Number	Item Description	Quantity
SZ-L-OD-OERP5B	SOLAR PUMP	1
SVE-000000024	24L SOLAR EXPANSION VESSEL	1
SKU-000000020	20L SOLAR FLUID	1
OZM-00000.75HP	MIXING VALVE	1
SKT-0000000000	1M PIPE TAILS AND FITTINGS	2
SKN-C-00000ERP	SOLAR CONTROLER	1
SZ-OG-000004	SOLAR PIPE ENTRY GASKET SET 4"	1
	ROOF MOUNTING KIT	1

OPTIONAL EXTRAS

Item Number	Item Description	Price (£)
SVB-00000000P	SOLAR DISCHARGE - PLASTIC	£108.33
SVS-000000000	SOLAR EXP VESSEL CONNECT SET	£67.62
SPD-16-50-0000	DN16 50M SOL SS PIPE DUO INS	£1,475.17
SZ-J-0000DN-16	SOLAR FITTING JOINER PACK DN16	£29.51

Navitas 2m/2.5m On Roof System



CERTIFIED

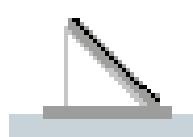

FLAT-ROOF 45

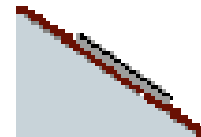

PITCHED-ROOF, Parallel

TECHNICAL DATA		
	2M	2.5M
Certification Number	BBA 0192	
Collector type	Roof-mounted collector	
Overall area [m2]	2.02	2.34
Absorber area [m2]	1.85	2.15
Aperture area [m2]	1.93	2.23
L x W x H [mm]	1.730 x 1.170 x 73	2.000 X . 1.170 X 73
Weight [kg]	31	32
Absorber capacity [l]	1.56	1.7
Housing	Al-frame	
Surface	Al, natural or anodized (improved corrosion resistance)	
Back plate	Al-sheet	
Absorber sheet	Al, high selectiv coated	
Absorption* [%]	95	
Emission* [%]	5	
Ø manifold [mm]	18 or 22 (¾ or 1")	
Ø risers [mm]	8	
Connections	blank (compression joint), coupling nut with flat seal	
Glass	3.2 mm tempered solar safety glass	
Transmittance of glass [%]	90	
Insulation	40 mm mineral wool plate	
Max. stagnation temperature	184 °C under test conditions	
Max. operating pressure	10 bar	
Proper heat transfer medium	Polypropylene glycol / water mixture	
Approved installation angle	min. 15°, max. 75°	
Packaging	Customer specific	

2M SYSTEM PRICES

Item Number	Item Description	Roof Dimensions W x L x H (mm)	Recommended Cylinder Size	Price (£)
SX-OR-2.0-0-02-S	2 PANEL 2M ON-ROOF SOLAR KIT - SLATE	2240 x 1730 x 83	250L	£2,172.78
SX-OR-2.0-0-02-T	2 PANEL 2M ON-ROOF SOLAR KIT - TILE	2240 x 1730 x 83	250L	£2,172.78
SX-OR-2.0-0-02-B	2 PANEL 2M ON-ROOF SOLAR KIT - BOLT	2240 x 1730 x 83	250L	£2,172.78
SX-OR-2.0-0-03-S	3 PANEL 2M ON-ROOF SOLAR KIT - SLATE	3710 x 1730 x 83	300L	£2,883.94
SX-OR-2.0-0-03-T	3 PANEL 2M ON-ROOF SOLAR KIT - TILE	3710 x 1730 x 83	300L	£2,883.94
SX-OR-2.0-0-03-B	3 PANEL 2M ON-ROOF SOLAR KIT - BOLT	3710 x 1730 x 83	300L	£2,883.94

2.5M SYSTEM PRICES

SX-OR-2.5-0-02-S	2 PANEL 2.5M ON-ROOF SOLAR KIT - SLATE	2240 x 1730 x 83	250L	£2,710.13
SX-OR-2.5-0-02-T	2 PANEL 2.5M ON-ROOF SOLAR KIT - TILE	2240 x 1730 x 83	250L	£2,710.13
SX-OR-2.5-0-03-S	3 PANEL 2.5M ON-ROOF SOLAR KIT - SLATE	3710 x 1730 x 83	300L	£3,685.73
SX-OR-2.5-0-03-T	3 PANEL 2.5M ON-ROOF SOLAR KIT - TILE	3710 x 1730 x 83	300L	£3,685.73

COMPONENTS INCLUDED

Item Number	Item Description	Quantity
SZ-L-OD-OERP5B	SOLAR PUMP	1
SVE-000000024	24L SOLAR EXPANSION VESSEL	1
SKU-000000020	20L SOLAR FLUID	1
OZM-00000.75HP	MIXING VALVE	1
SKT-0000000000	1M PIPE TAILS AND FITTINGS	2
SKN-C-00000ERP	SOLAR CONTROLER	1
SZ-OG-000004	SOLAR PIPE ENTRY GASKET SET 4"	1
	ROOF MOUNTING KIT	1

OPTIONAL EXTRAS

Item Number	Item Description	Price (£)
SVB-000000000P	SOLAR DISCHARGE - PLASTIC	£108.33
SVS-0000000000	SOLAR EXP VESSEL CONNECT SET	£67.62
SPD-16-50-0000	DN16 50M SOL SS PIPE DUO INS	£1,475.17
SZ-J-0000DN-16	SOLAR FITTING JOINER PACK DN16	£29.51

Navitas In Roof System

TECHNICAL DATA

Certification Number	BBA 0192
Collector type	Roof-mounted collector
Overall area [m2]	2.02
Absorber area [m2]	1.85
Aperture area [m2]	1.93
L x W x H [mm]	1.730 x 1.170 x 83
Weight [kg]	31
Absorber capacity [l]	1.56
Housing	Al-frame
Surface	Al, natural or anodized (improved corrosion)
Back plate	Al-sheet
Absorber sheet	Al, high selectiv coated
Absorption* [%]	95
Emission* [%]	5
Ø manifold [mm]	18 or 22 (¾ or 1")
Ø risers [mm]	8
Connections	blank (compression joint), coupling nut with flat seal
Glass	3.2 mm tempered solar safety glass
Transmittance of glass [%]	90
Insulation	40 mm mineral wool plate
Max. stagnation temperature	184 °C under test conditions
Max. operating pressure	10 bar
Proper heat transfer medium	Polypropylene glycol / water mixture
Approved installation angle	min. 15°, max. 75°
Packaging	Customer specific



SYSTEM PRICE

Item Number	Item Description	Roof Dimensions W x L x H (mm)	Recommended Cylinder Size	Price (£)
SX-IR02.N-0001	1 PANEL 2M IN-ROOF SOLAR KIT	1680 x 2000 x 83	210L	£2,035.33
SX-IR02.N-0002	2 PANEL 2M IN-ROOF SOLAR KIT	2420 x 2000 x 83	250L	£2,721.70
SX-IR02.N-0003	3 PANEL 2M IN-ROOF SOLAR KIT	3380 x 2000 x 83	300L	£3,517.93
SX-IR02.N-0004	4 PANEL 2M IN-ROOF SOLAR KIT	5060 x 2000 x 83	Per Design Spec	£4,248.63
SX-IR02.N-0005	5 PANEL 2M IN-ROOF SOLAR KIT	6740 x 2000 x 83	Per Design Spec	£5,044.86
SX-IR02.N-0006	6 PANEL 2M IN-ROOF SOLAR KIT	8420 x 2000 x 83	Per Design Spec	£5,775.57

COMPONENTS INCLUDED

Item Number	Item Description	Quantity
SZ-L-OD-OERP5B	SOLAR PUMP	1
SVE-000000024	24L SOLAR EXPANSION VESSEL	1
SKU-000000020	20L SOLAR FLUID	1
OZM-00000.75HP	MIXING VALVE	1
SKT-0000000000	1M PIPE TAILS AND FITTINGS	2
SKN-C-00000ERP	SOLAR CONTROLER	1
	ROOF MOUNTING KIT	1

OPTIONAL EXTRAS

Item Number	Item Description	Price (£)
SVB-000000000P	SOLAR DISCHARGE - PLASTIC	£108.33
SVS-0000000000	SOLAR EXP VESSEL CONNECT SET	£67.62
SPD-16-50-0000	DN16 50M SOL SS PIPE DUO INS	£1,475.17
SZ-J-0000DN-16	SOLAR FITTING JOINER PACK DN16	£29.51

Joule Solar Systems - Twin Solar Unvented Cylinders Options

Joule Cyclone Plus range of unvented hot water cylinder is designed to work with any solar system on the market.

Joule UK have manufactured to the highest standards and supplied with innovative components to ensure quick recovery, low heat loss, and economic use of energy.

The Joule Cyclone Plus Twin Solar unvented cylinder is insulated with 50mm 100% CFC and HCFC free polyurethane to minimise heat loss and heated by boiler and supports Thermal and PV solar and comes available in 150L - 300L capacity.

Features Include;

- Manufactured from high grade Duplex stainless steel
- Fitted with Branded Quality Components
- Factory pre built Gas or Oil Boiler Ready



CYLINDER OPTIONS

Item Code	Description	Price (£)
Solar		
TRJMVS-0150LFB	150L CYCLONE PLUS TWIN SOLAR STANDARD	£690.05
TRJMVS-0180LFB	180L CYCLONE PLUS TWIN SOLAR STANDARD	£709.19
TRJMVS-0210LFC	210L CYCLONE PLUS TWIN SOLAR STANDARD	£727.86
TRJMVS-0250LFC	250L CYCLONE PLUS TWIN SOLAR STANDARD	£765.15
TRJMVS-0300LFC	300L CYCLONE PLUS TWIN SOLAR STANDARD	£775.70

Item Code	CAPACITY	WEIGHT EMPTY	WEIGHT FULL	WATER VOLUME	ERP ENERGY RATING	REHEAT TIME INDIRECT	STANDING LOSS	STANDING LOSS	PRIMARY COIL RATING	SOLAR COIL SURFACE AREA	SOLAR COIL RATING
TRJMVS-0150LFB	150	40	182	150	B	16.05	1.26	53	16.33	0.656	17.49
TRJMVS-0150SFB	150	40	182	150	C	16.05	1.26	55	16.33	0.656	17.49
TRJMVS-0180LFB	180	45	216	180	B	19.5	1.4	58	15.9	0.656	18.85
TRJMVS-0180SFB	180	45	216	180	C	19.5	1.4	60	15.9	0.656	18.85
TRJMVS-0210LFC	210	48	250	210	C	23.7	1.48	62	18.15	0.656	17.18
TRJMVS-0210SFB	210	48	250	210	C	23.7	1.48	66	18.15	0.656	17.18
TRJMVS-0250LFC	250	53	294	250	C	26.33	1.76	73	17.8	0.76	19.00
TRJMVS-0300LFC	300	63	353	300	C	29.3	2.03	85	19.35	0.878	20.87

Joule Buffer Tanks - Mild Steel & Stainless Steel Buffer Tanks

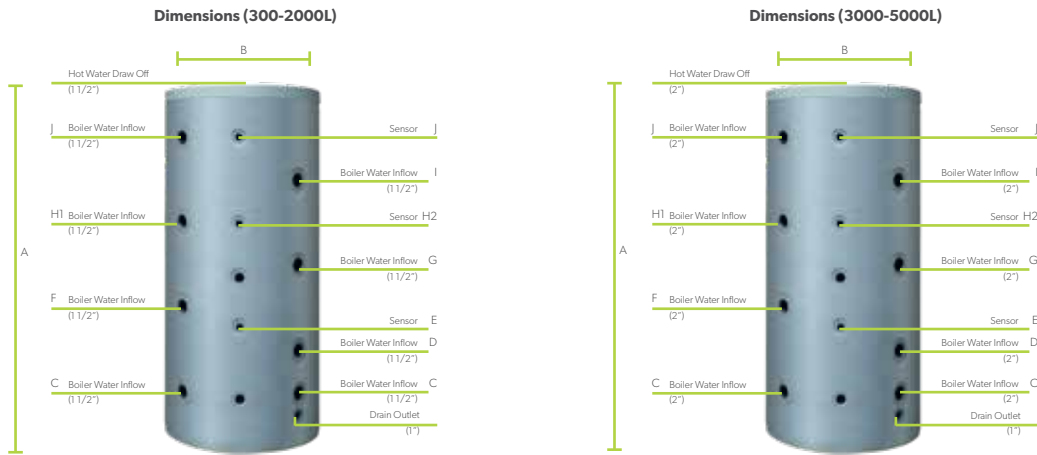

Mild Steel Buffer

Capacity	200L	300L	380L	500L	800L	1000L	1500L	2000L	3000L	4000L	5000L
Code Without Coil	BBMSD-00200NFC	BBMSD-00300NFC	BBMSD-00380NFC	BBMSD-00500NFC	BBMSD-00800NFC	BBMSD-01000NFC	BBMSD-01500NFC	BBMSD-02000NFC	BBMSD-03000NFC	BBMSD-04000NFC	BBMSD-05000NFC
Code With Coil	BBMSI-00200NFC	BBMSI-00300NFC	BBMSI-00380NFC	BBMSI-00500NFC	BBMSI-00800NFC	BBMSI-01000NFC	BBMSI-01500NFC	BBMSI-02000NFC	BBMSI-03000NFC	BBMSI-04000NFC	BBMSI-05000NFC
Height - A (mm)	1140	1615	1685	1925	1730	2050	2000	2500	2750	2355	2855
Diameter - B (mm)	670	670	700	600	790	790	1100	1100	1250	1600	1600
Weight Empty (Kg)	60	75	90	105	125	150	210	235	300	380	440
Weight Full (Kg)	283	397	486	572	853	1033	1689	2258	3241	4365	5421
Hot Water Volume (L)	223	322	380	467	728	883	1479	2023	2941	3985	4981
C	220	220	250	250	250	250	385	385	425	445	445
D	-	410	450	485	435	500	660	660	725	675	760
E	315	500	565	565	570	570	485	800	830	970	920
F	485	600	635	715	620	740	740	930	1040	910	1075
G	555	785	825	945	820	980	1152	1205	1360	1140	1390
H1	605	975	1015	1180	1020	1240	960	1480	1680	1365	1705
H2	785	975	1135	1145	1020	1240	1122	1480	1680	1365	1705
I	785	1165	1210	1410	1215	1485	1535	1755	1995	1605	2020
J	885	1355	1400	1640	1410	1730	1435	2025	2250	1840	2335
Energy Efficiency Class	B	B	C	C	C	C	C	C	C	C	C
Max Working Pressure (Bar)	3	3	3	3	3	3	3	3	3	3	3
Max Working Temperature (°C)	95	95	95	95	95	95	95	95	95	95	95

Stainless Steel Buffer Tank

Capacity	125L	150L	170L	200L	250L	300L	400L	500L	600L
	BBSSD-00125NFC	BBSSD-00150NFC	BBSSD-00170NFC	BBSSD-00200NFC	BBSSD-00250NFC	BBSSD-00300NFC	BBSSD-00400NFC	BBSSD-00500NFC	BBSSD-00600NFC
Height (mm)	1030	1190	1310	1490	1815	1600	1570	1900	2250
Diameter (mm)	530	530	530	530	530	600	710	710	710
Weight Empty (kg)	23	26	33	40	42	50	65	77	108
Weight Full (kg)	125	150	170	200	250	300	400	498	600
No. Direct Connections	8	8	8	8	8	8	8	8	8
Diameter of Direct Connections	1" F	1" F	1" F	1" F	1" F	1" F	1" F	1" F	1" F
Drain 1/2"	no	no	no	no	no	no	no	no	no
Insulation Thickness (mm)	40	40	40	40	40	40	50	50	50
Standing Heat Loss (W)	50	55	58	81	87	92	102	115	119
ERP Rating	B	B	B	C	C	C	C	C	C
No of Immersions Fitted	2	2	2	2	2	2	2	2	2
Immersion Size	1¾	1¾	1¾	1¾	1¾	1¾	1¾	1¾	1¾



Mild Steel Buffer

Item No;	Item Description	Price
Code Without Coil		
BBMSD-00100NFC	BUFF MS 100L NO COIL STD C (1.5" TAPS)	£490.96
BBMSD-00200NFC	BUFF MS 200L NO COIL STD C (1.5" TAPS)	£502.96
BBMSD-00300NFC	BUFF MS 300L NO COIL STD C 2" TAPS	£631.26
BBMSD-00380NFC	BUFF MS 380L NO COIL STD C 2" TAPS	£790.22
BBMSD-00500NFC	BUFF MS 500L NO COIL STD C 2" TAPS	£986.62
BBMSD-00600NFC	BUFF MS 600L NO COIL STD C	£1,566.43
BBMSD-00800NFC	BUFF MS 800L NO COIL STD C 2" TAPS	£1,356.02
BBMSD-01000NFC	BUFF MS 1000L NO COIL STD C 2" TAPS	£1,402.78
BBMSD-01250NFC	BUFF MS 1250L NO COIL STD C	£2,361.33
BBMSD-01500NFC	BUFF MS 1500L NO COIL STD C 2" TAPS	£1,823.60
BBMSD-02000NFC	BUFF MS 2000L NO COIL STD C 2" TAPS	£2,735.41
BBMSD-02500NFC	BUFF MS 2500L NO COIL STD C	£3,647.23
BBMSD-03000NFC	BUFF MS 3000L NO COIL STD C 2" TAPS	£3,927.77
BBMSD-04000NFC	BUFF MS 4000L NO COIL STD C 2" TAPS	£4,816.19
BBMSD-05000NFC	BUFF MS 5000L NO COIL STD C 2" TAPS	£5,844.89
Code Without Coil		
BBMSI-00200NFC	BUFF MS 200L WITH SOLAR STD C	£724.78
BBMSI-00300NFC	BUFF MS 300L WITH SOLAR STD C 2" TAPS	£865.05
BBMSI-00380NFC	BUFF MS 380L WITH SOLAR STD C 2" TAPS	£1,070.78
BBMSI-00500NFC	BUFF MS 500L WITH SOLAR STD C 2" TAPS	£1,178.34
BBMSI-00800NFC	BUFF MS 800L WITH SOLAR STD C 2" TAPS	£1,683.33
BBMSI-01000NFC	BUFF MS 1000L WITH SOLAR STD C 2" TAPS	£1,730.09
BBMSI-01250NFC	BUFF MS 1250L WITH SOLAR STD C	£3,039.33
BBMSI-01500NFC	BUFF MS 1500L WITH SOLAR STD C 2" TAPS	£2,244.44
BBMSI-02000NFC	BUFF MS 2000L WITH SOLAR STD C 2" TAPS	£3,226.39
BBMSI-03000NFC	BUFF MS 3000L WITH SOLAR STD C	£6,508.88
BBMSS-00800NFC	BUFF MS 800L TWIN SOLAR STD C	£2,314.57
BBMSS-01000NFC	BUFF MS 1000L TWIN SOLAR STD C	£2,641.89
BBMSS-01500NFC	BUFF MS 1500L TWIN SOLAR STD C	£3,623.85
BBMSS-02000NFC	BUFF MS 2000L TWIN SOLAR STD C	£4,371.97

Stainless Steel Buffer

Item No;	Item Description	Price
BBSSD-00125NFC	BUFF SS 125L NO COIL STD C	£1,227.91
BBSSD-00150NFC	BUFFER SS 150L WITHOUT SOLAR	£1,254.78
BBSSD-00170NFC	BUFF SS 170L NO COIL STD C	£1,122.22
BBSSD-00200NFC	BUFFER SS 200L WITHOUT SOLAR	£1,372.41
BBSSD-00250NFC	BUFF SS 250L NO COIL STD C	£1,533.61
BBSSD-00300NFC	BUFFER SS 300L WITHOUT SOLAR	£1,743.39
BBSSD-00400NFC	BUFFER SS 400L WITHOUT SOLAR	£2,243.79
BBSSD-00500NFC	BUFFER SS 500L WITHOUT SOLAR	£2,408.55
BBSSD-00600NFC	BUFF SS 600L NO COIL STD C	£3,399.05
BBSSD-00750NFC	BUFF SS 750L NO COIL STD C	£6,733.31
BBSSD-00800NFC	BUFF SS 800L NO COIL STD C	£8,002.31
BBSSD-01000NFC	BUFF SS 1000L NO COIL STD C	£13,686.68



Head Office Address:

Joule UK, Unit 1 & Unit 3, Leftfield Park, Park Road, West Yorkshire, WF8 4PS

Sales: 0330 808 8488 | **Email:** sales@jouleuk.co.uk | **Website:** www.jouleuk.co.uk

Joule endeavour to keep the content of this brochures up to date as possible. We reserve the right to make changes to all Joule products and services at anytime. To ensure you have the most current information please contact Joule direct.