



skylo

side entry
ball valve



WARNING

We shall not be responsible or liable for any failure of, or damage to, this plumbing product caused by the use of chlorine/bleach cleaners or related products added to the tank water. Use of such products will void the warranty and may result in product failure, possibly causing property damage. Do not over tighten plastic nuts and always turn off water supply when installing/removing toilet cistern parts.

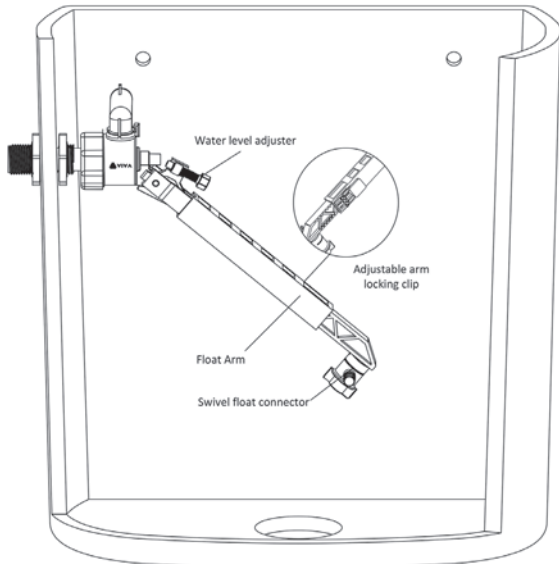

Please note: Save this instruction sheet for future reference
IMPORTANT: DO NOT use plumber's putty to seal this fitting

For more information please contact:

VIVA Sanitary

Units 1-2 Capitol Trading Park, Kirkby Bank Road
Knowsley Industrial Estate, Liverpool, L33 7SY

Tel: 0151 546 0531 **Fax:** 0151 549 4187

E-mail: sales@vivasanitary.co.uk

INSTALLATION INSTRUCTIONS

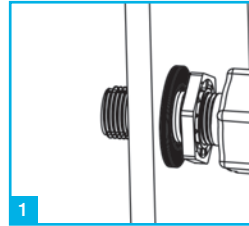

1 Remove the plastic washer and nut from the thread and position the valve in the cistern.

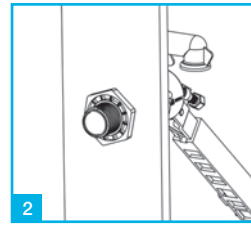

2 Secure valve to the cistern by replacing the plastic washer and screwing the nut to the thread. Do not over tighten.

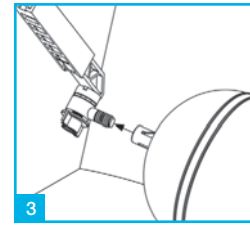

3 Fit suitable ball float to end of float arm. The position of the ball can be adjusted by loosening plastic wing nut, when desired position is achieved re-tighten wing nut.

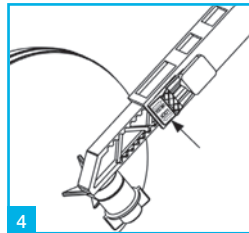

4 The arm length can also be adjusted by sliding the adjustment clip to unlock, move the arm in or out to desired length then lock the clip.

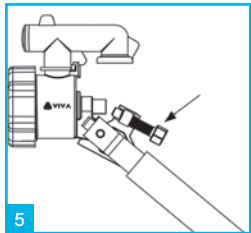

5 The water level can be adjusted by turning the adjustment screw (clockwise for less water, anticlockwise for more water).

TROUBLESHOOTING

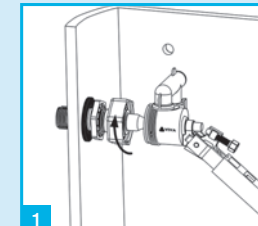

1 Ensure water is switched off and loosen the retaining nut.

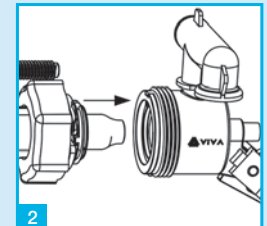

2 Remove the valve from the retaining nut.

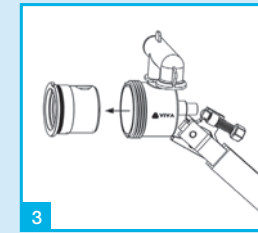

3 To access the diaphragm washer remove white plastic insert.

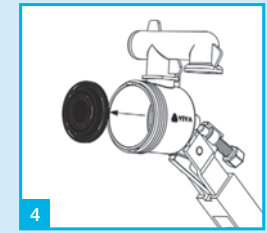

4 Remove the diaphragm washer and clean or replace.

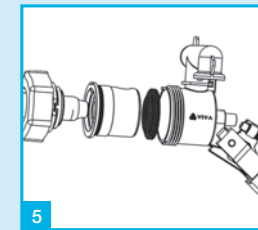

5 Re-connect valve.

Installation videos and further information available now.

