



ELECTRISTOVE XD 1 & 2

CELSI FIRES MODEL NO. CESSMDRE-ERP (B-1004620)

CELSI FIRES MODEL NO. CESLMDRE-ERP (B-1004621)

CELSI FIRES MODEL NO. CESSGDRE-ERP (B-1004622)

CELSI FIRES MODEL NO. CESLGDRE-ERP (B-1004623)

Packing Checklist

- Electric Stove
- Remote Control Handset
- 2 x AAA Batteries
- Guarantee Card
- Instruction Manual
- Anti-tilt chain kit

IMPORTANT

PLEASE READ THESE INSTRUCTIONS CAREFULLY BEFORE
INSTALLATION AND USE OF THIS ELECTRIC FIRE.

RETAIN FOR FUTURE REFERENCE.

THIS PRODUCT IS ONLY SUITABLE FOR WELL INSULATED SPACES OR
OCCASIONAL USE.

This appliance is not intended for use by persons (including children) with reduced physical, sensory or learning disabilities, or lack of experience and knowledge, unless given supervision or instruction concerning use of the appliance by a person responsible for their safety.

IMPORTANT SAFETY ADVICE

WHEN USING AN ELECTRICAL APPLIANCE, BASIC PRECAUTIONS SHOULD ALWAYS BE FOLLOWED TO REDUCE THE RISK OF FIRE, ELECTRIC SHOCK AND INJURY TO PERSONS, INCLUDING THE FOLLOWING IMPORTANT SAFETY ADVICE.

DO NOT cover or obstruct the airflow to the front of the heater. This is to avoid over-heating of the product.

DO NOT leave the heater unattended while it is in use. Always turn the appliance to the OFF position and switch off at the mains socket when not in use.

DO NOT leave children unsupervised whilst the appliance is switched on

DO NOT operate this appliance with a damaged cord or plug, or after the appliance malfunctions, has been dropped or damaged in any way.

DO NOT install a timer switch to operate the appliance.

DO NOT use this appliance as a freestanding appliance. It must always be fitted into a fireplace opening.

DO NOT insert or allow objects to enter any ventilation or exhaust openings on the appliance. To prevent possible damage do not block air intakes or exhaust openings in any manner.

DO NOT place this appliance near flammable materials, surfaces or substances, as there may be a risk of fire. Keep flammable materials, surfaces or substances at least 1 metre away from the front of the product.

DO NOT switch on the fire if volatile vapours are present in the room.

DO NOT use this appliance in any areas where petrol, paint or other flammable liquids are stored e.g. a garage or a workshop as the appliance contains components capable of producing a spark.

DO NOT let bare skin touch any hot surfaces to avoid burns and personal injury. The heater vent will get hot when in use.

DO NOT use outdoors.

CAUTION- Some parts of this product can become hot and cause burns. Particular attention has to be given where children and vulnerable people are present.

This appliance is for household use only

Product Technical Data Sheet

Supplier Name / Trademark	CELSI
Supplier Model Identifier	B-1004620, B-1004621, B-1004622, B-1004623 ELECTRISTOVE XD 1 & 2
Voltage	230v AC 50HZ
Fuse	13Amp
Nominal Heat Output (Measured)	2.0 kW
Minimum Heat Output (Indicative)	1.0 kW
Maximum Continuous Heat Output	2.0 kW
Auxiliary Electricity Consumption At Nominal Heat Output	0.0112 kW
Auxiliary Electricity Consumption at Minimum Heat Output	0.0112 kW
Auxiliary Electricity Consumption at Standby Mode	0.0003 kW
Type of heat Output / Room Temperature Control	With electronic room temperature control
Other Control Options	None
Manufacturers Name and Address	BFM Europe Ltd. Gordon Banks Drive, Trentham Lakes, Stoke-on-Trent, Staffs, ST4 4TJ Tel: (01782) 339000

Unpacking

Remove and discard the plastic bag.

Be responsible when handling the packing materials.

Keep the original packaging for future transportation and/or storage.

Check all accessories are removed from the packaging before storing it away for future use.

KEEP PLASTIC BAGS AWAY FROM CHILDREN!

Choosing a suitable location

The stove must have a minimum clearance of 50mm to combustible material on all sides. A clearance of minimum 50mm to non-combustible materials is also required to ensure correct operation.

This appliance is for indoor installation only and is not designed to be installed outside. The appliance must be kept away from any source of damp or moist conditions. Avoid any close contact with water.

Important Notice: To reduce heat losses and to prevent any chimney up draught affecting the operation of your fire we recommend that the chimney is blocked off.

If there is any doubt regarding the suitability of the installation site please contact your supplier. The fire can be connected directly to a fused spur or plugged into a mains socket.

Ensure that the plug socket-outlet connection for this appliance is accessible. It **MUST** be readily accessible for easy electrical isolation in the event of servicing and replacing components etc. This appliance **MUST NOT** be located immediately below an electrical socket-outlet.

Installation

Installation must be carried out by a qualified and competent person.

Connect the appliance to single-phase AC supply of the voltage specified on the rating plate.

Should the fire be connected directly into the mains supply, then a fused switched spur with a 13 Amp fuse must be fitted. It is imperative that the power supply is capable of handling a load of 2000 watts (2kW). Do not use an extension lead.

This appliance must be earthed.

Always ensure that all electrical work complies with the relevant Building Regulations and the Electrical Code of Practice. All electrical work should be carried out by a qualified electrician.

Installing anti-tilt chain

If mounting this stove onto an uneven floor surface the anti-tilt chain supplied should be fitted to prevent the stove from falling forwards when opening the door.

Step 1 Take out the anti-tilt parts from the packaging, which contains 5 off components as detailed below:

1 off wall plug, 1 off screw, 2 off metal brackets, 1 off plastic chain.

Step 2 Unscrew the screw on the back panel of the stove as shown.

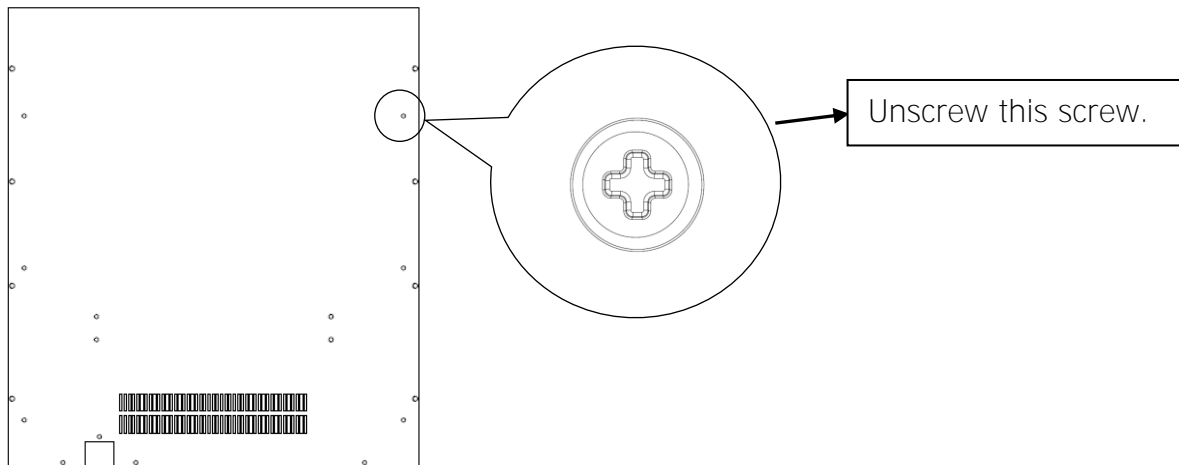

Step 3 Attach the metal bracket to the back panel using the original screws as shown.

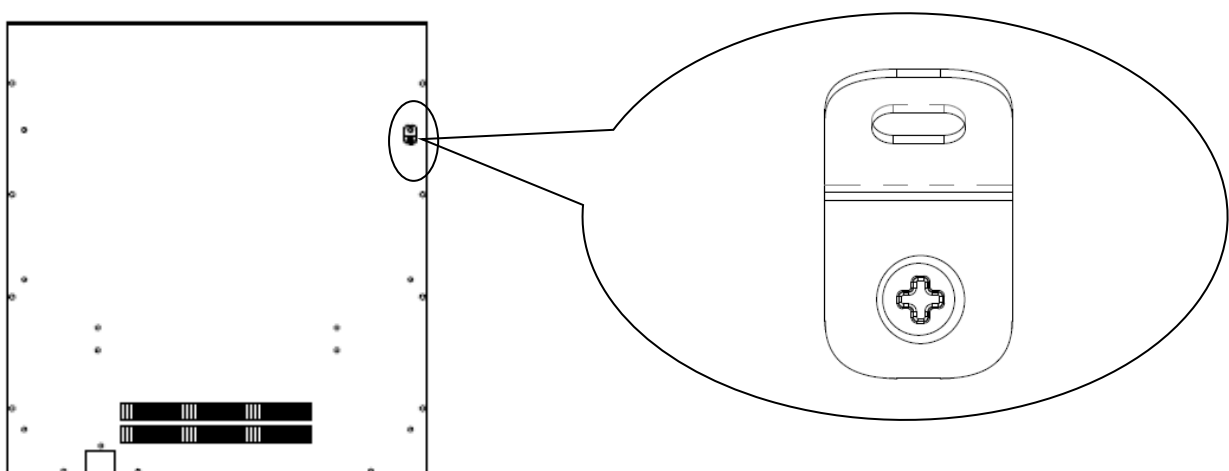

Step 4 Drill a hole into the wall and insert the wall plug, fix the other metal bracket to the wall using the screw provided.

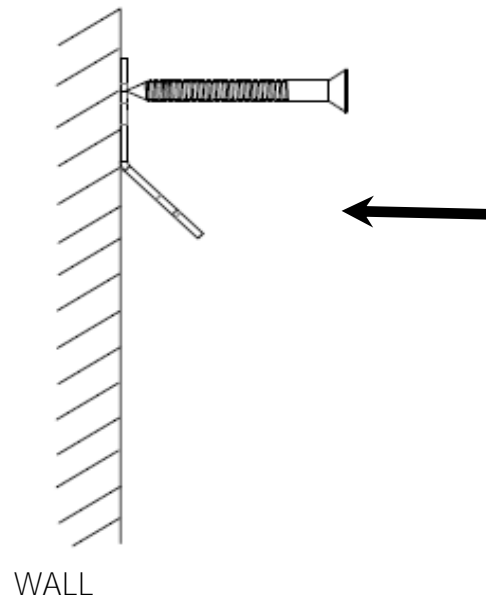

Step 5 Insert the chain through the metal brackets as shown.

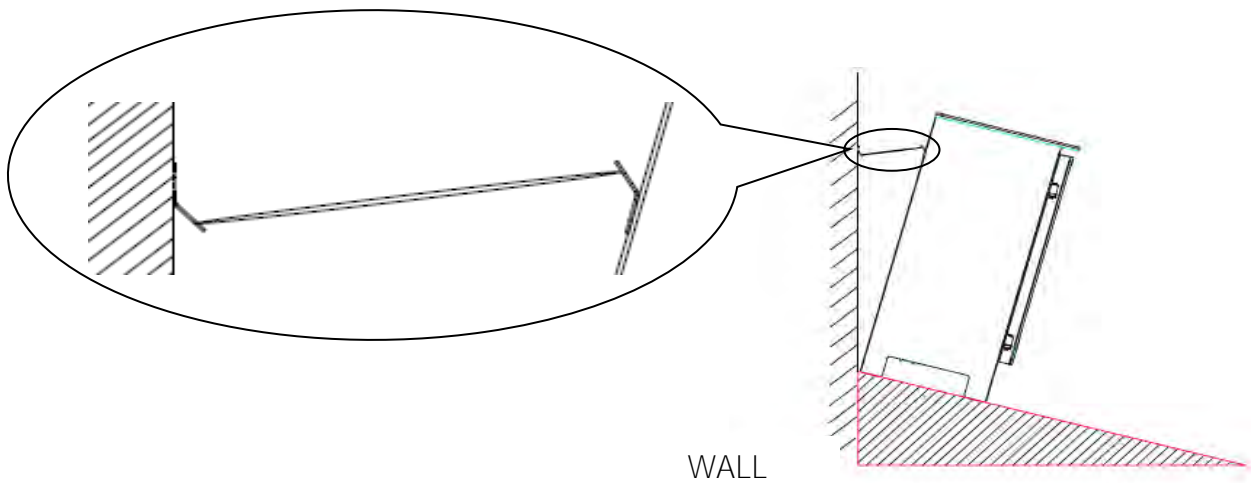

Operating the Stove

Manual Control

This appliance can be operated manually using the controls situated behind the door of the stove or by the included remote control handset.

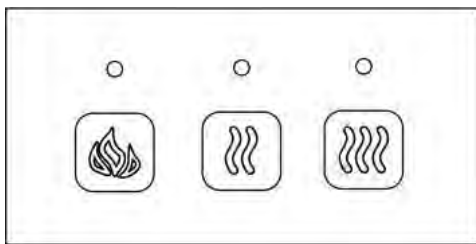

ON / OFF Power Switch 

This switch is used to turn the mains supply to the appliance ON or OFF. This needs to be in the ON position for both manual and remote operation of the fire.

Flame 

Pressing this button will switch on the flame effect lights only. Repeated pressing will cycle through the 4 different flame levels (High, Med, Low and Dynamic lighting) or switch the flame effect off completely. (The flame effect will not switch off if the fire is on Low or high heat)

Low Heat 

Use this button to switch on Low Heat (1kW), press again to switch off heat.

High Heat 

Use this button to switch on High Heat (2kW), press again to switch off heat.

When the heater is switched off the fan will still continue to run for a short period to allow the appliance to cool down.

NOTE: If the handset temperature is set below the current room temperature then the heater will not operate until the room temperature has dropped

Remote Control

Remove the battery cover on the back of the handset by sliding downwards and insert 2 x AAA batteries ensuring that the batteries are fitted correctly. Refit the battery cover.

Ensure that the ON / OFF Power Switch on the stove is in the ON position.



OPERATING INSTRUCTION WITH REMOTE CONTROL

Point the remote control handset directly towards the stove and press the appropriate button to operate the fire. The handset has a memory function which will restart the fire with the last settings except for the Sleep timer function which will always reset to OFF.



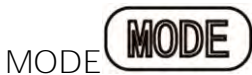







The Power button turns the appliance ON or OFF.







The mode button is used to cycle through the 3 available setting modes – Flame , sleep timer  and heat 







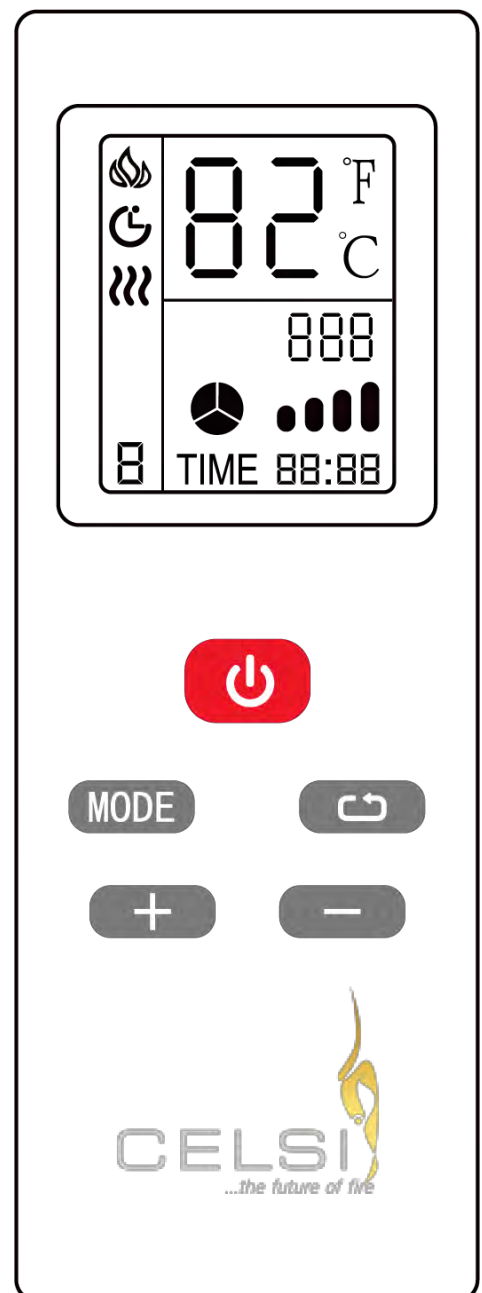

When the flame icon  is selected, the brightness icon  will blink for 5 seconds. During this period the flame effect brightness can be changed using the  or  buttons to select one of the four available flame effect settings (High,  Medium,  Low,  dynamic) or OFF. If no buttons are pressed within 5 seconds the brightness icon will stop blinking and the flame brightness will be set to memory. To change the flame brightness again press the cycle button  which will blink the brightness icon allowing the flame brightness to be changed. Note: The flame effect will not switch off if the fire is on Low or high heat.



When the timer icon  is selected, the 00 icon will blink, pressing the  or  buttons within 5 seconds will adjust the sleep timer range from 1-8 hours. If no buttons are pressed within 5 seconds the timer icon will stop blinking and the timer will be set to memory. To change the timer again press the cycle button  which will blink the timer icon allowing the duration to be changed. To switch off the timer function set this to 00.



HEAT

When the heat icon  is selected and blinking, pressing the  or  buttons within 5 seconds will adjust the heat output between Low Heat (1kW) , High Heat (2kW) , and OFF (OF) options. If no buttons are pressed within 5 seconds the heat icon will stop blinking and the heat output will be set to memory. To adjust again press the cycle button  which will blink the heat icon allowing the heat output to be changed.



Pressing the cycle button  switches between heat output and room temperature setting.



When the temperature display  blinks use the  or  buttons within 5 seconds to set the desired room temperature (18°C to 27°C)

NOTE: If the handset temperature is set below the current room temperature then the heater will not operate until the room temperature has dropped.

To switch the temperature display between Celsius and Fahrenheit, press and hold the  button for 5 seconds.

Setting the Clock

Press and hold the cycle button  for 5 seconds until the day number flashes. Using the  or  buttons set this between 1 and 7 to represent the current day of the week (1 – Monday, 2 Tuesday, 3 Wednesday etc).

Press the cycle button  to highlight the TIME hour display and set using the  or  buttons.

Press the cycle button  to highlight the TIME minute display and set using the  or  buttons.

Leave for 5 seconds to lock in the settings.

IMPORTANT

This appliance is fitted with an automatic thermal cut-out safety feature to reduce the risk of damage to the appliance in the event of overheating e.g. when covered. If the thermal cut out has detected an abnormal temperature rise within the appliance it will shut off the fan heater and will prevent it from restarting.

If this occurs switch off the fire using the ON/OFF switch and allow the appliance to cool. Ensure that there are no obstructions to the fan heater outlet or fan blades etc. If the fire is installed within a chimney ensure that the chimney is blocked off as any draught can cause this problem. Once cool, the thermal cut-out will have reset allowing you to continue safely using your fire.

If the heater is still not operating correctly after 20 mins disconnect the appliance and seek expert advice.

Maintenance Instructions

Always remove the plug from the socket-outlet and allow the heater to cool down before cleaning it.

Light accumulated dust may be removed from the appliance with a soft dry cloth.

The exterior surface of the appliance can be cleaned with a soft damp cloth (not dripping wet). Dry the exterior surface before operating the heater.

Household glass cleaner can be used on the fire glass.

WARNING!

Do not immerse the heater in water.

Do not use any cleaning chemicals such as detergents and abrasives.

Do not allow the interior to get wet as this could create a hazard.

In the event of malfunction do not try to repair the appliance yourself as this may result in a fire hazard or electric shock.

Environment

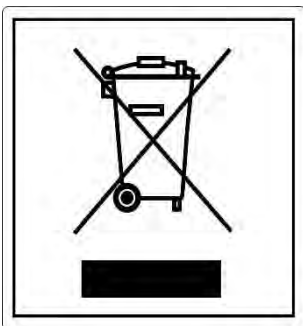

Do not dispose of electrical appliances as unsorted municipal waste. Use separate collection facilities. Contact your local government for information regarding the collection services available in your local area. If electrical appliances are disposed of in landfills or dumps hazardous substances can leak into the groundwater and get into the food chain, thus damaging your health and wellbeing.

When replacing old appliances with new ones the retailer is legally obligated to take away your old appliance for disposal free of charge.

Warranty

In the unlikely event of a problem occurring due to a manufacturing fault within 24 months from the date of purchase the appliance will be repaired or replaced free of charge.

This warranty does not cover consumable items which have a limited lifespan. If a problem should occur, the nature of the problem together with the date of purchase and installer information should be immediately reported to the retailer that the appliance was purchased from. Proof of purchase will be required so the original invoice should be retained.



Issue 3

BFM Europe Ltd
Gordon Banks Drive
Trentham Lakes
Stoke-on-Trent
Staffs
ST4 4TJ

Technical Queries: 01782 339039
Service Fault Enquiries: 01782 339008